

ISS.	AMEND	DATE
1	ISSUED	25/09/20

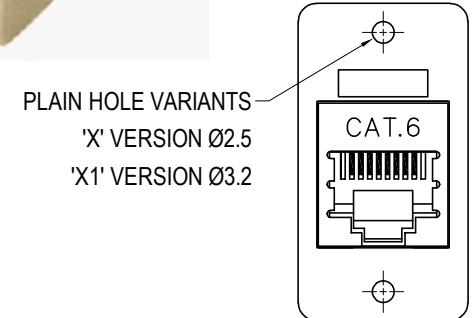
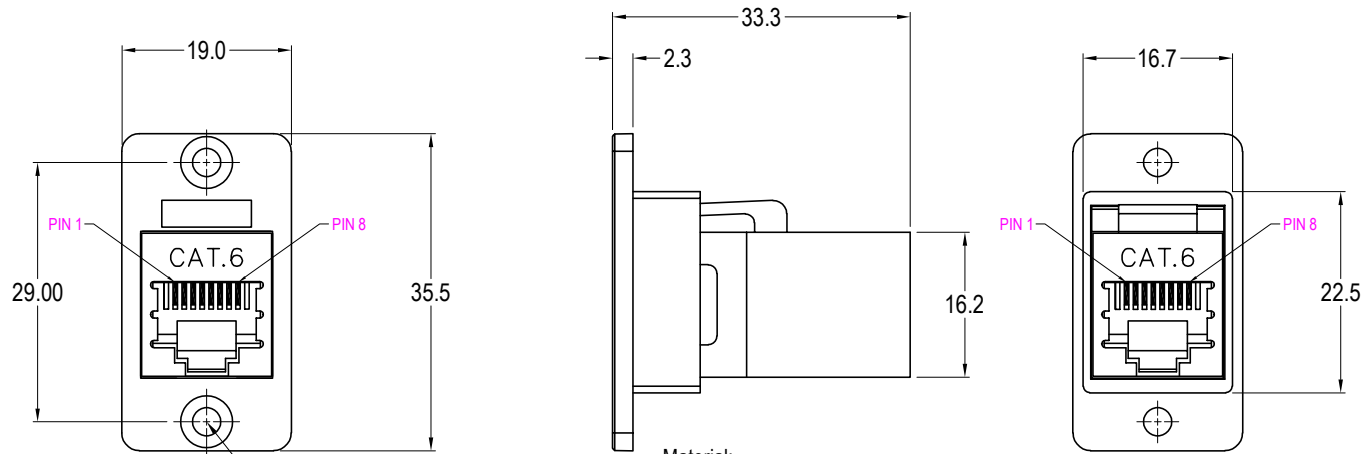
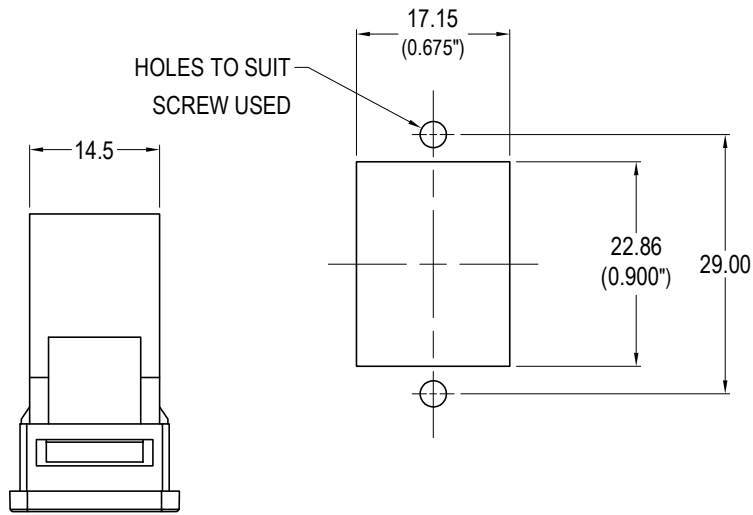
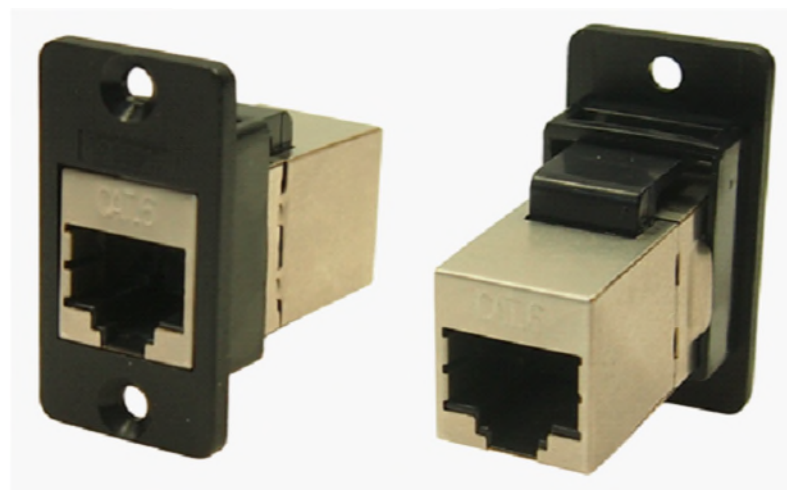

VARIANTS	
PART NO.	HOLE DETAILS
CP30622S	HOLE Ø3.2 x CSK 90° x Ø5.85
CP30622SX	PLAIN HOLE Ø2.5
CP30622SX1	PLAIN HOLE Ø3.2

3x HOLE VARIANTS
 Ø3.2mm CSK 90° x Ø5.85
 'X' PLAIN Ø2.5 HOLES
 'X1' PLAIN Ø3.2 HOLES

- Material:
1. RJ45 In-Line Coupler: PC/ABS, UL 94V-0
 2. RJ45 In-Line Coupler Contact: Phosphor Bronze, 3-50 micro inches gold plating over nickel plate.
 3. PCB: FR4, UL 94V-0
 4. Frame: Polyamide UL 94V-2

- Performance:
1. T568A & T568B wiring.
 2. Meet ISO/IEC 11801 and EN50173
 3. Meet ANSI/TIA/EIA 568B.2
 4. Operating Temperatures: Min -10°C Max +70°C

RoHS

COMPLIANT

TOLERANCE
 NO DEC. PLACE ±
 1 DEC. PLACE ±
 2 DEC. PLACE ±
 HOLE Ø ±
 ANGLES ±
 UNLESS OTHERWISE STATED