

SACC-M12MS-5CON-PG 7-M - Connector



1663116

<https://www.phoenixcontact.com/us/products/1663116>

Please be informed that the data shown in this PDF document is generated from our online catalog. Please find the complete data in the user documentation. Our general terms of use for downloads are valid.



Connector, Universal, 5-position, Plug straight M12, coding: A, Screw connection, knurl material: Zinc die-cast, nickel-plated, cable gland Pg7, external cable diameter 4 mm ... 6 mm

Your advantages

- Safe use in the field, thanks to a high degree of protection
- Screw connection: proven connection technology for a large selection of different conductors

Commercial data

Item number	1663116
Packing unit	1 pc
Minimum order quantity	1 pc
Sales key	BF30
Product key	BF2CAA
Catalog page	Page 22 (C-2-2019)
GTIN	4017918116583
Weight per piece (including packing)	24.16 g
Weight per piece (excluding packing)	23.13 g
Customs tariff number	85366990
Country of origin	DE

SACC-M12MS-5CON-PG 7-M - Connector



1663116

<https://www.phoenixcontact.com/us/products/1663116>

Technical data

Notes

Assembly instruction:

NOTE: Observe the permissible bending radii when laying conductors, since the degree of protection may be put in jeopardy if the bending forces are too high. Alleviate mechanical loads upstream of the connector, e.g. by using cable ties.

Mounting

Assembly instructions

The wires can be connected both with ferrules and without ferrules

Product properties

Product type	Circular connector (cable-side)
Sensor type	Universal
Number of positions	5
No. of cable outlets	1
Shielded	no
Coding	A
Cable outlet	straight
Pg screw connection	Pg7

Insulation characteristics

Overvoltage category	II
Degree of pollution	3

Dimensions

Dimensional drawing

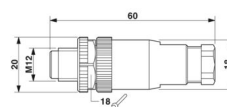

Width	20 mm
Height	20 mm
Length	60 mm

External dimensions

Outside diameter	4 mm ... 6 mm
------------------	---------------

Housing

Diameter housing	20 mm
------------------	-------

Material specifications

Flammability rating according to UL 94	HB
Seal material	NBR
Material of grip body	PA

SACC-M12MS-5CON-PG 7-M - Connector



1663116

<https://www.phoenixcontact.com/us/products/1663116>

Contact material	CuZn
Contact surface material	CuSnZn
Contact carrier material	PA
Material for screw connection	Zinc die-cast, nickel-plated

Connection data

Conductor connection

Connection method	Screw connection
Connection cross section	0.25 mm ² ... 0.75 mm ² (without ferrule)
	0.14 mm ² ... 0.75 mm ² (with ferrule)
	0.25 mm ² ... 0.75 mm ² (solid)
Connection cross section AWG	24 ... 18 (without ferrule)
	26 ... 20 (with ferrule)
Stripping length of the individual wire	5 mm
Tightening torque	0.4 Nm (M12 knurl)
	0.2 Nm (Screw terminal blocks)
	0.8 Nm ... 1 Nm (Pressure screw)

Electrical properties

Rated surge voltage	1.5 kV
Contact resistance	≤ 8 mΩ
Insulation resistance	≥ 100 MΩ
Nominal voltage U _N	48 V AC
	60 V DC
Nominal current I _N	4 A

Mechanical properties

Mechanical data

Insertion/withdrawal cycles	≥ 50
-----------------------------	------

Connector

Connection 1

Head design	Plug
Head cable outlet	straight
Head thread type	M12
Coding	A

Cable/line

Signal type/category	Universal
Stripping length of the individual wire	5 mm

Environmental and real-life conditions

Ambient conditions

SACC-M12MS-5CON-PG 7-M - Connector



1663116

<https://www.phoenixcontact.com/us/products/1663116>

Degree of protection	IP67
Ambient temperature (operation)	-40 °C ... 85 °C (Plug / socket)

Standards and regulations

Standard designation	M12 connector
Standards/specifications	IEC 61076-2-101

SACC-M12MS-5CON-PG 7-M - Connector

1663116

<https://www.phoenixcontact.com/us/products/1663116>

Drawings

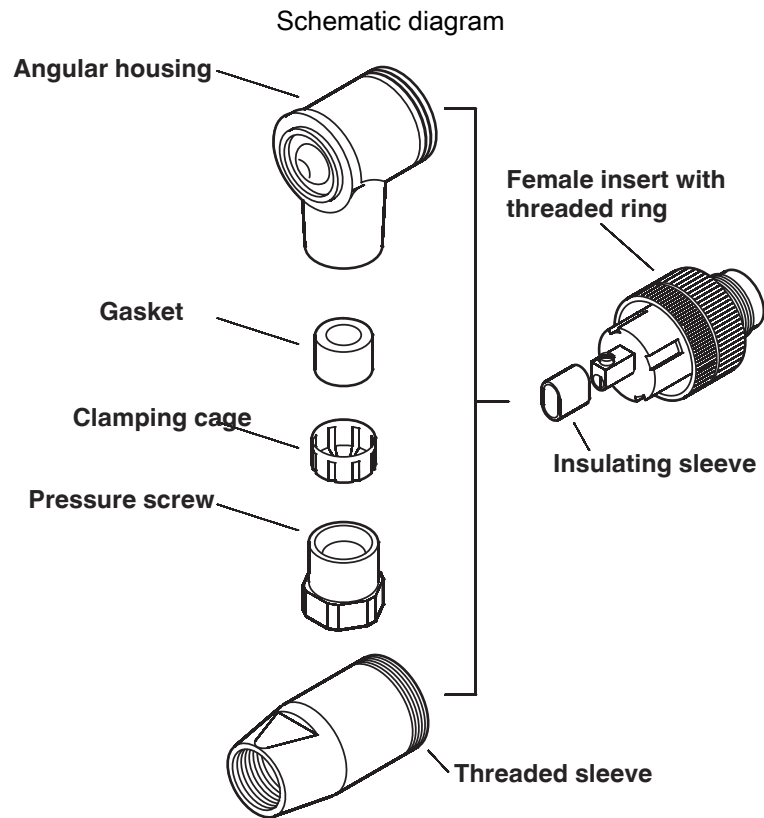

Male/Female M12

SACC-M12MS-5CON-PG 7-M - Connector

1663116

<https://www.phoenixcontact.com/us/products/1663116>

Schematic diagram

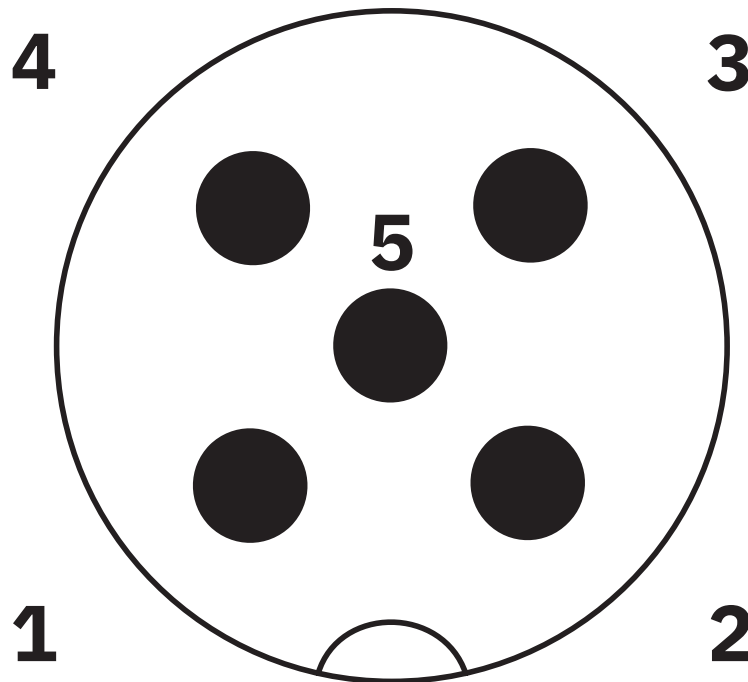

Pin assignment M12 male connector, 5-pos., A-coded, male side

Dimensional drawing

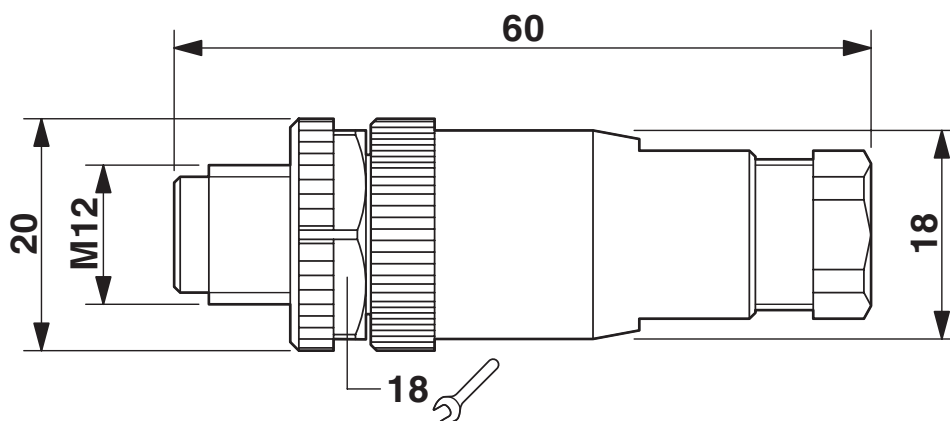

Plug, M12 x 1, straight

SACC-M12MS-5CON-PG 7-M - Connector

1663116

<https://www.phoenixcontact.com/us/products/1663116>

Schematic diagram

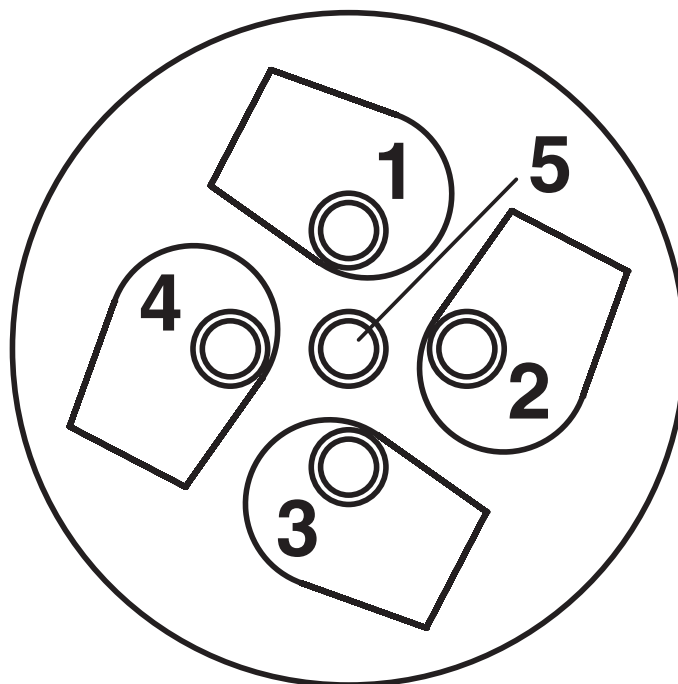

Cable connection side M12 (screw connection)

SACC-M12MS-5CON-PG 7-M - Connector





1663116

<https://www.phoenixcontact.com/us/products/1663116>

Approvals

To download certificates, visit the product detail page: <https://www.phoenixcontact.com/us/products/1663116>

 cUL Recognized Approval ID: FILE E 221474				
	Nominal voltage U_N	Nominal current I_N	Cross section AWG	Cross section mm^2
	60 V	4 A	-	-

 UL Recognized Approval ID: FILE E 221474				
	Nominal voltage U_N	Nominal current I_N	Cross section AWG	Cross section mm^2
	60 V	4 A	-	-

cULus Recognized

SACC-M12MS-5CON-PG 7-M - Connector



1663116

<https://www.phoenixcontact.com/us/products/1663116>

Classifications

ECLASS

ECLASS-11.0	27440102
ECLASS-12.0	27440116
ECLASS-13.0	27440116

ETIM

ETIM 9.0	EC002635
----------	----------

UNSPSC

UNSPSC 21.0	39121400
-------------	----------

SACC-M12MS-5CON-PG 7-M - Connector



1663116

<https://www.phoenixcontact.com/us/products/1663116>

Environmental product compliance

EU RoHS

Fulfills EU RoHS substance requirements	Yes
Exemption	6(c)

China RoHS

Environment friendly use period (EFUP)	EFUP-50
	An article-related China RoHS declaration table can be found in the download area for the respective article under "Manufacturer declaration". For all articles with EFUP-E, no China RoHS declaration table issued and required.

EU REACH SVHC

REACH candidate substance (CAS No.)	Lead(CAS: 7439-92-1)
SCIP	d93bebd2-5471-4cb7-a9e9-24611f594177

SACC-M12MS-5CON-PG 7-M - Connector

1663116

<https://www.phoenixcontact.com/us/products/1663116>



Accessories

SACC-M12-SET/2,5-3,5 - Connector

1436505

<https://www.phoenixcontact.com/us/products/1436505>



Sensor/actuator connector, accessories, pressure screw and Pg7 seal, for unshielded M12 connector, cable diameter 2.5 mm - 3.5 mm

PROT-M12 FS-PA-CHAIN - Sealing cap

1430873

<https://www.phoenixcontact.com/us/products/1430873>



M12 sealing cap made of plastic with fixing band, for sensor cables, for free M12 plugs

SACC-M12MS-5CON-PG 7-M - Connector



1663116

<https://www.phoenixcontact.com/us/products/1663116>

SAC-5P-100,0-PUR/0,34 - Cable reel

1501676

<https://www.phoenixcontact.com/us/products/1501676>



By the meter, Cable reel, PUR halogen-free, black-gray RAL 7021, 5-wire, color single wire: brown, white, blue, black, green-yellow, cable length: 100 m

A 0,25- 5 - Ferrule

3202465

<https://www.phoenixcontact.com/us/products/3202465>



Ferrule, color: silver

SACC-M12MS-5CON-PG 7-M - Connector



1663116

<https://www.phoenixcontact.com/us/products/1663116>

TSD 04 SAC - Torque screwdriver

1208429

<https://www.phoenixcontact.com/us/products/1208429>



Torque screwdriver, with preset torque of 0.4 Nm and 4 mm hexagonal drive for M12 connectors

TSD-M 1,2NM - Torque screwdriver

1212224

<https://www.phoenixcontact.com/us/products/1212224>



Torque screw driver, accuracy as per EN ISO 6789 standard, adjustable from 0.3 - 1.2 Nm

SACC-M12MS-5CON-PG 7-M - Connector



1663116

<https://www.phoenixcontact.com/us/products/1663116>

TSD-M SAC-BIT ADAPTER - Adapter insert

1212600

<https://www.phoenixcontact.com/us/products/1212600>



Adapter bit for TSD-M...torque tools, E6.3-1/4" drive with 4 mm hexagon to accommodate SAC bits

SACC BIT M12-D20 - Tool

1208445

<https://www.phoenixcontact.com/us/products/1208445>



Nut for assembling M12 connectors for assembly with a knurl diameter of 20 mm, for 4 mm hexagonal drive

SACC-M12MS-5CON-PG 7-M - Connector



1663116

<https://www.phoenixcontact.com/us/products/1663116>

CRIMPFOX 6H - Crimping pliers

1212046

<https://www.phoenixcontact.com/us/products/1212046>



Crimping pliers, for ferrules without insulating collar according to DIN 46228 Part 1 and ferrules with insulating collar according to DIN 46228 Part 4, 0.14 mm² ... 6 mm², unlockable pressure lock, lateral entry

SZF 1-0,6X3,5 - Screwdriver

1204517

<https://www.phoenixcontact.com/us/products/1204517>



Actuation tool, for ST terminal blocks, also suitable for use as a bladed screwdriver, size: 0.6 x 3.5 x 100 mm, 2-component grip, with non-slip grip

Phoenix Contact 2024 © - all rights reserved
<https://www.phoenixcontact.com>

Phoenix Contact USA
586 Fulling Mill Road
Middletown, PA 17057, United States
(+717) 944-1300
info@phoenixcon.com