

OptiMOS™-P 2 Small-Signal-Transistor
Features

- P-channel
- Enhancement mode
- Logic level (4.5V rated)
- Avalanche rated
- Qualified according to AEC Q101
- 100% lead-free; RoHS compliant
- Halogen-free according to AEC61249-2-21

Product Summary

V_{DS}		30	V
$R_{DS(on),max}$	$V_{GS}=10\text{ V}$	150	$m\Omega$
	$V_{GS}=4.5\text{ V}$	270	
I_D		-1.5	A

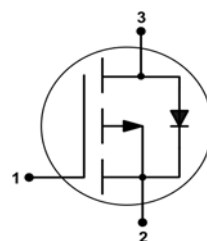

PG-SOT-23

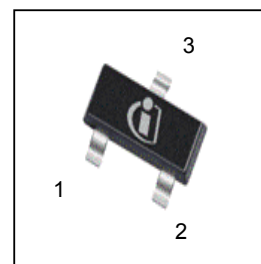

Type	Package	Tape and Reel Information	Marking	Lead Free	Packing
BSS315P	PG-SOT23	H6327: 3000 pcs/ reel	YCs	Yes	Non dry

Maximum ratings, at $T_j=25\text{ °C}$, unless otherwise specified

Parameter	Symbol	Conditions	Value	Unit
Continuous drain current	I_D	$T_A=25\text{ °C}$	-1.5	A
		$T_A=70\text{ °C}$	-1.18	
Pulsed drain current	$I_{D,pulse}$	$T_A=25\text{ °C}$	-6	
Avalanche energy, single pulse	E_{AS}	$I_D=-1.5\text{ A}$, $R_{GS}=25\ \Omega$	11	mJ
Reverse diode dv/dt	dv/dt	$I_D=-1.5\text{ A}$, $V_{DS}=-16\text{ V}$, $di/dt=-200\text{ A}/\mu\text{s}$, $T_{j,max}=150\text{ °C}$	6	kV/ μs
Gate source voltage	V_{GS}		± 20	V
Power dissipation ¹⁾	P_{tot}	$T_A=25\text{ °C}$	0.5	W
Operating and storage temperature	T_j , T_{stg}		-55 ... 150	$^{\circ}\text{C}$
ESD Class		JESD22-A114 -HBM	0 (<250V)	V
Soldering Temperature			260 $^{\circ}\text{C}$	$^{\circ}\text{C}$
IEC climatic category; DIN IEC 68-1			55/150/56	$^{\circ}\text{C}$

Parameter	Symbol	Conditions	Values			Unit
			min.	typ.	max.	

Thermal characteristics

Thermal resistance, junction - ambient	R_{thJA}	minimal footprint ¹⁾	-	-	250	K/W
--	------------	---------------------------------	---	---	-----	-----

Electrical characteristics, at $T_j=25\text{ °C}$, unless otherwise specified
Static characteristics

Drain-source breakdown voltage	$V_{(BR)DSS}$	$V_{GS}=0V, I_D=-250\mu A$	-30	-	-	V
Gate threshold voltage	$V_{GS(th)}$	$V_{DS}=V_{GS}, I_D=-11\mu A$	-2.0	-1.5	-1.0	
Drain-source leakage current	I_{DSS}	$V_{DS}=-30V, V_{GS}=0V, T_j=25\text{ °C}$	-	-	-1	μA
		$V_{DS}=-30V, V_{GS}=0V, T_j=150\text{ °C}$	-	-	-100	
Gate-source leakage current	I_{GSS}	$V_{GS}=-20V, V_{DS}=0V$	-	-	-100	nA
Drain-source on-state resistance	$R_{DS(on)}$	$V_{GS}=-4.5V, I_D=-1.1A$	-	177	270	$m\Omega$
		$V_{GS}=-10V, I_D=-1.5A$	-	113	150	
Transconductance	g_{fs}	$ V_{DS} >2 I_D R_{DS(on)max}, I_D=-1.18A$	-	2.7	-	S

¹⁾ Performed on 40mm² FR4 PCB. The traces are 1mm wide, 70 μ m thick and 20mm long; they are present on both sides of the PCB.

Parameter	Symbol	Conditions	Values			Unit
			min.	typ.	max.	

Dynamic characteristics

Input capacitance	C_{iss}	$V_{GS}=0\text{ V}, V_{DS}=15\text{ V},$ $f=1\text{ MHz}$	-	212	282	pF
Output capacitance	C_{oss}		-	69	91	
Reverse transfer capacitance	C_{rss}		-	56	84	
Turn-on delay time	$t_{d(on)}$	$V_{DD}=-15\text{ V},$ $V_{GS}=-10\text{ V},$ $I_D=-1.5\text{ A}, R_G=6\ \Omega$	-	5.0	-	ns
Rise time	t_r		-	6.5	-	
Turn-off delay time	$t_{d(off)}$		-	14.3	-	
Fall time	t_f		-	7.5	-	

Gate Charge Characteristics

Gate to source charge	Q_{gs}	$V_{DD}=-15\text{ V},$ $I_D=-1.5\text{ A},$ $V_{GS}=0\text{ to }5\text{ V}$	-	-0.56	-	nC
Gate to drain charge	Q_{gd}		-	-1.2	-	
Gate charge total	Q_g		-	-2.3	-	
Gate plateau voltage	$V_{plateau}$		-	-2.9	-	V

Reverse Diode

Diode continuous forward current	I_S	$T_A=25\text{ }^\circ\text{C}$	-	-	-0.5	A
Diode pulse current	$I_{S,pulse}$		-	-	-6	
Diode forward voltage	V_{SD}	$V_{GS}=0\text{ V}, I_F=-1.5\text{ A},$ $T_j=25\text{ }^\circ\text{C}$	-	-0.86	-1.1	V
Reverse recovery time	t_{rr}	$V_R=10\text{ V}, I_F=-1.5\text{ A},$ $di_F/dt=100\text{ A}/\mu\text{s}$	-	8.2	-	ns
Reverse recovery charge	Q_{rr}		-	2.1	-	

1 Power dissipation

$$P_{\text{tot}} = f(T_A)$$

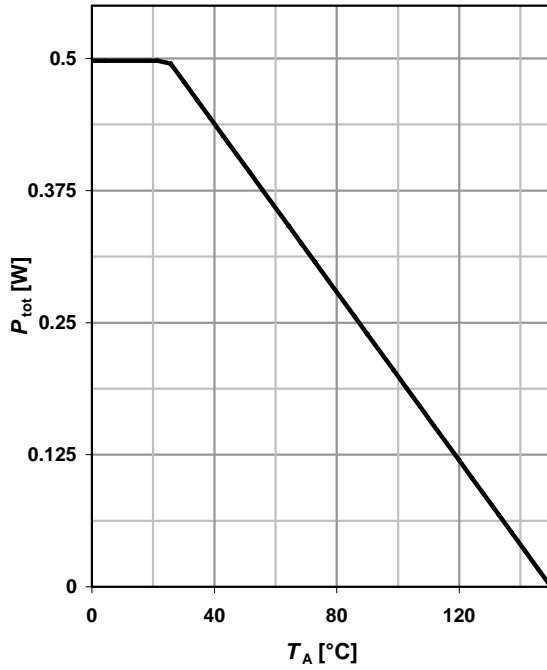

2 Drain current

$$I_D = f(T_A); V_{\text{GS}} \geq 10 \text{ V}$$

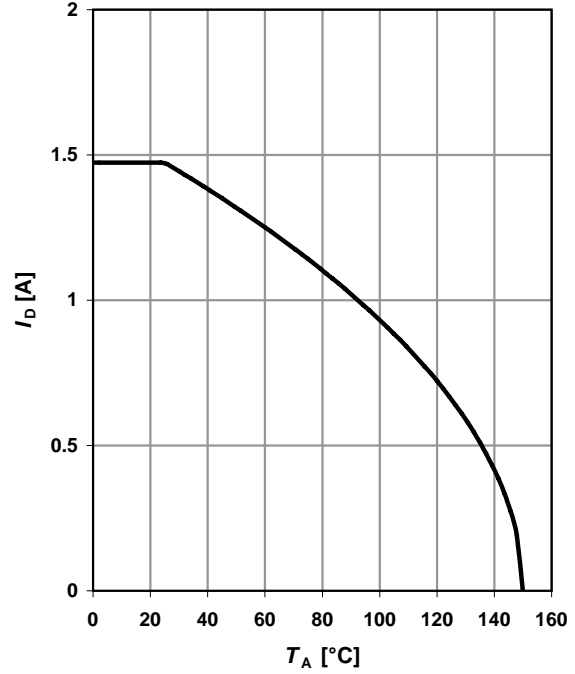

3 Safe operating area

$$I_D = f(V_{\text{DS}}); T_A = 25 \text{ °C}; D = 0$$

parameter: t_p

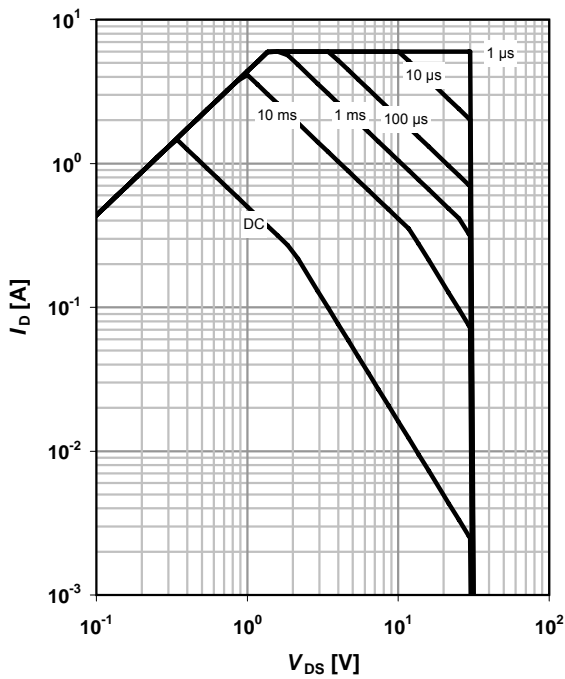

4 Max. transient thermal impedance

$$Z_{\text{thJA}} = f(t_p)$$

parameter: $D = t_p / T$

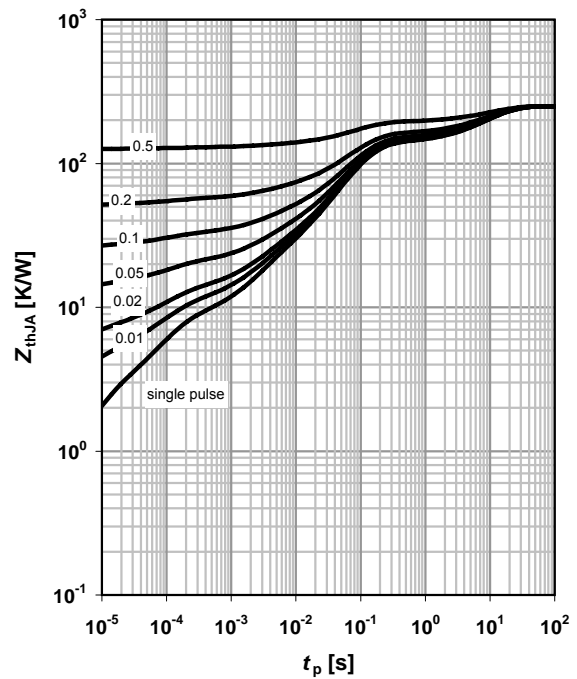

5 Typ. output characteristics

$I_D = f(V_{DS}); T_j = 25\text{ }^\circ\text{C}$

parameter: V_{GS}

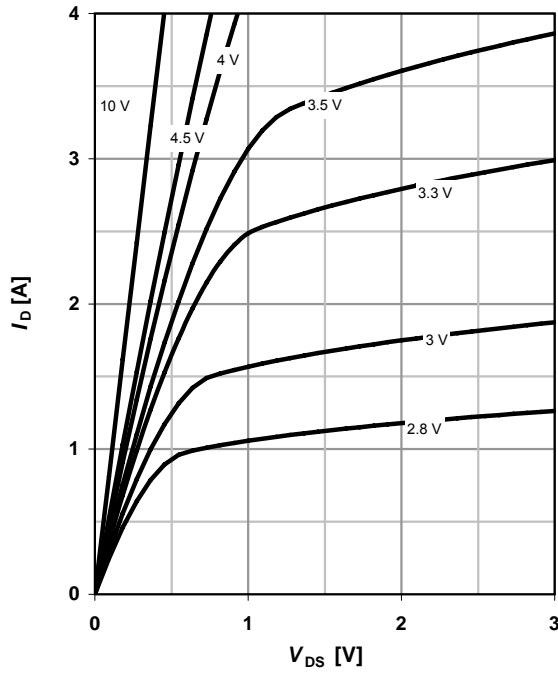

6 Typ. drain-source on resistance

$R_{DS(on)} = f(I_D); T_j = 25\text{ }^\circ\text{C}$

parameter: V_{GS}

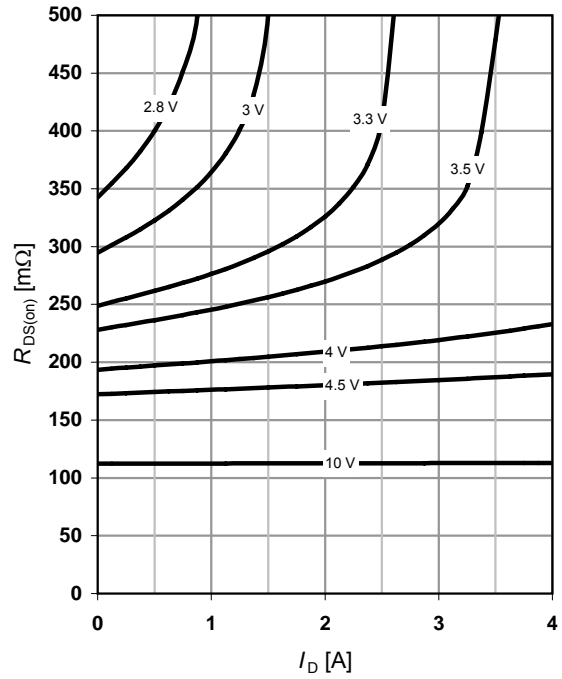

7 Typ. transfer characteristics

$I_D = f(V_{GS}); |V_{DS}| > 2|I_D|R_{DS(on)max}$

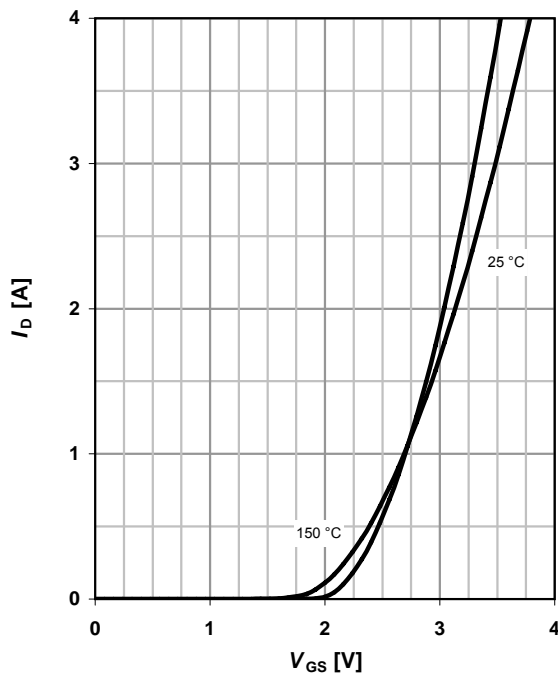

8 Typ. forward transconductance

$g_{fs} = f(I_D); T_j = 25\text{ }^\circ\text{C}$

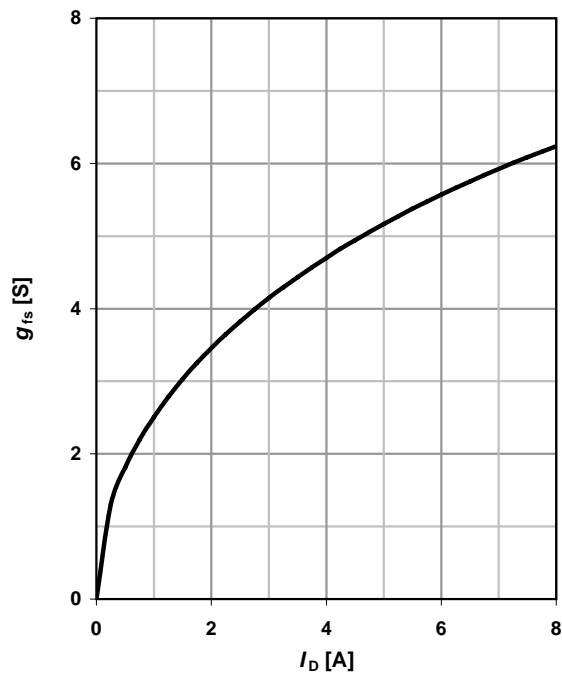

9 Drain-source on-state resistance

$R_{DS(on)} = f(T_j); I_D = -1.5 \text{ A}; V_{GS} = -10 \text{ V}$

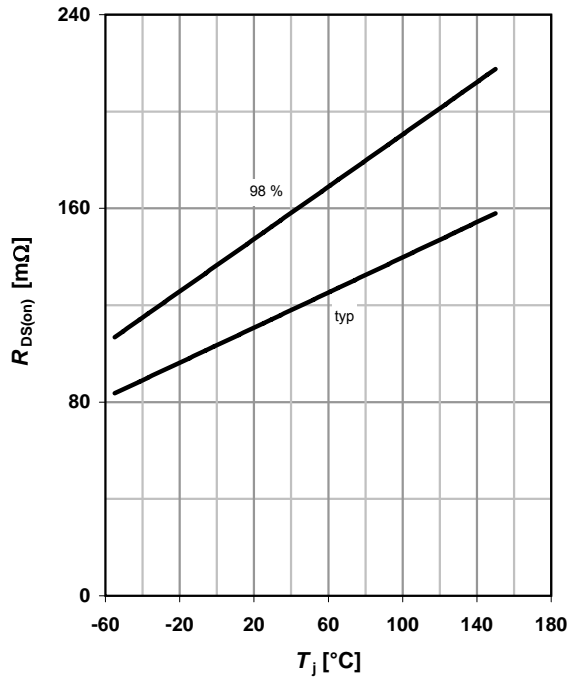

10 Typ. gate threshold voltage

$V_{GS(th)} = f(T_j); V_{DS} = V_{GS}; I_D = -11 \mu\text{A}$

parameter: I_D

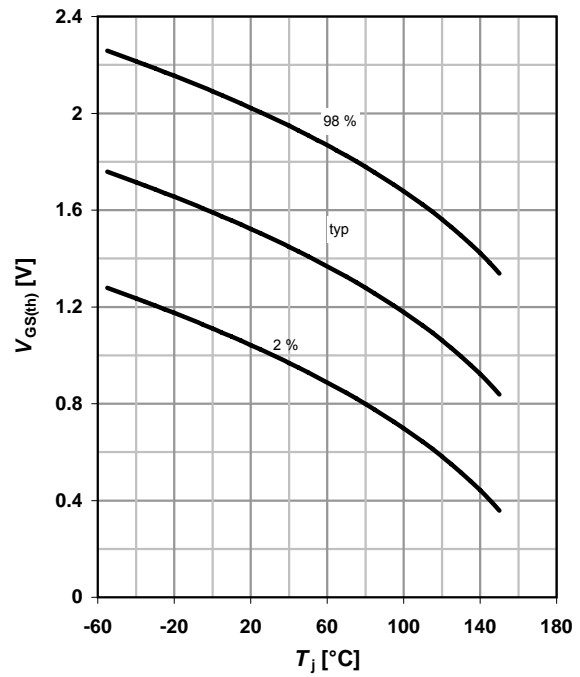

11 Typ. capacitances

$C = f(V_{DS}); V_{GS} = 0 \text{ V}; f = 1 \text{ MHz}; T_j = 25^\circ\text{C}$

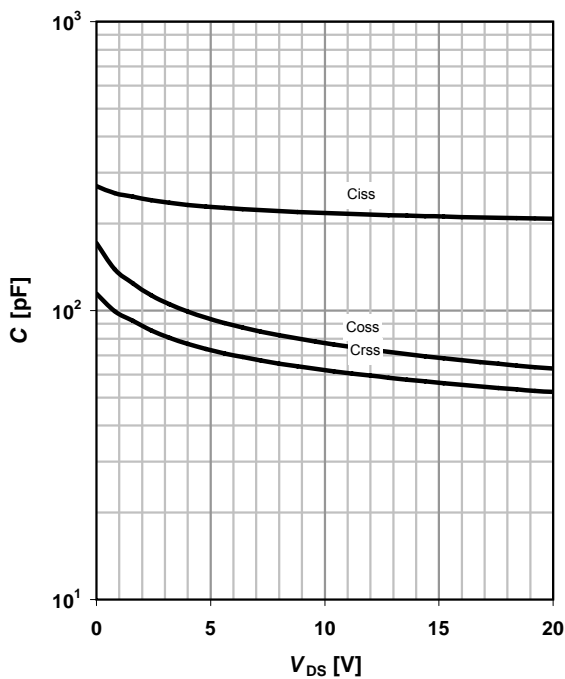

12 Forward characteristics of reverse diode

$I_F = f(V_{SD})$

parameter: T_j

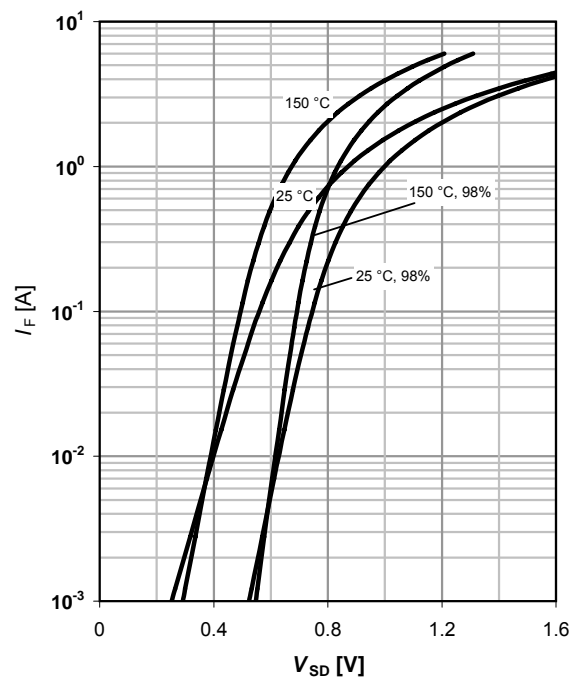

13 Avalanche characteristics

$I_{AS}=f(t_{AV}); R_{GS}=25\ \Omega$

parameter: $T_{j(start)}$

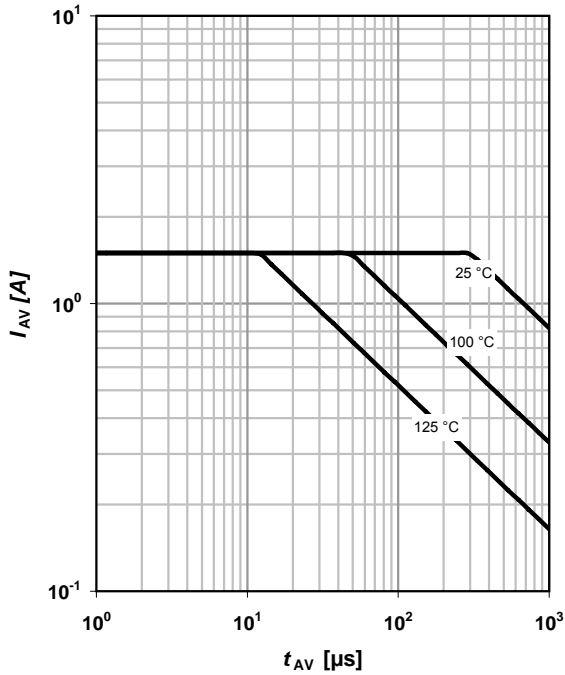

14 Typ. gate charge

$V_{GS}=f(Q_{gate}); I_D=-1.5\ A\ pulsed$

parameter: V_{DD}

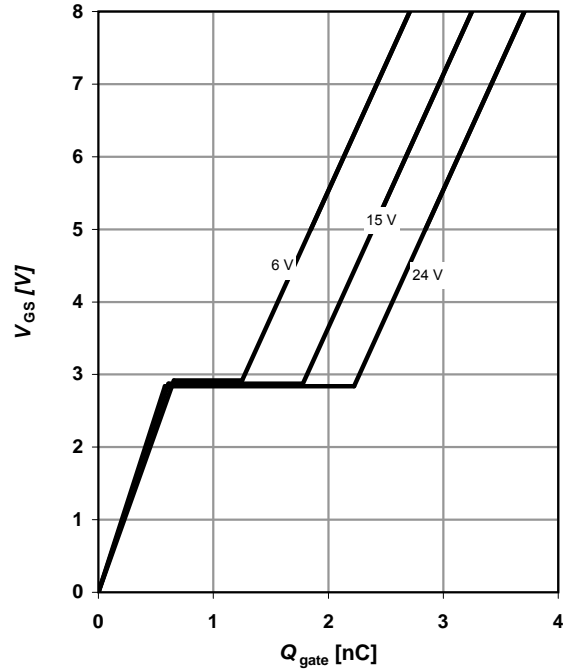

15 Drain-source breakdown voltage

$V_{BR(DSS)}=f(T_j); I_D=250\ \mu A$

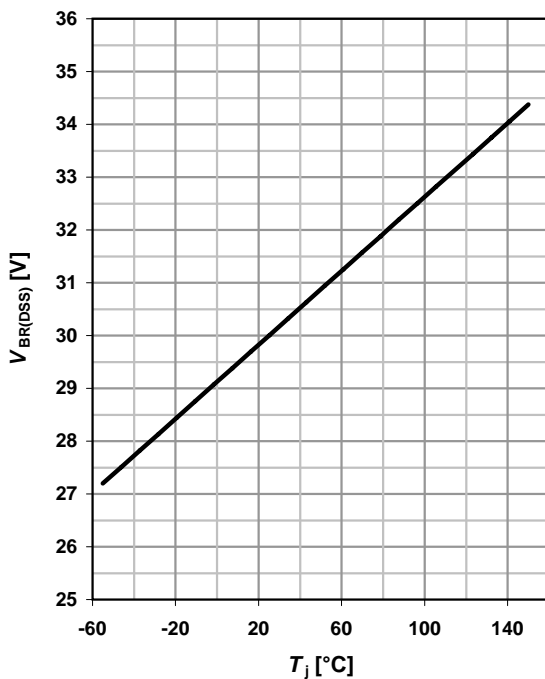

16 Gate charge waveforms



SOT23

Package Outline:

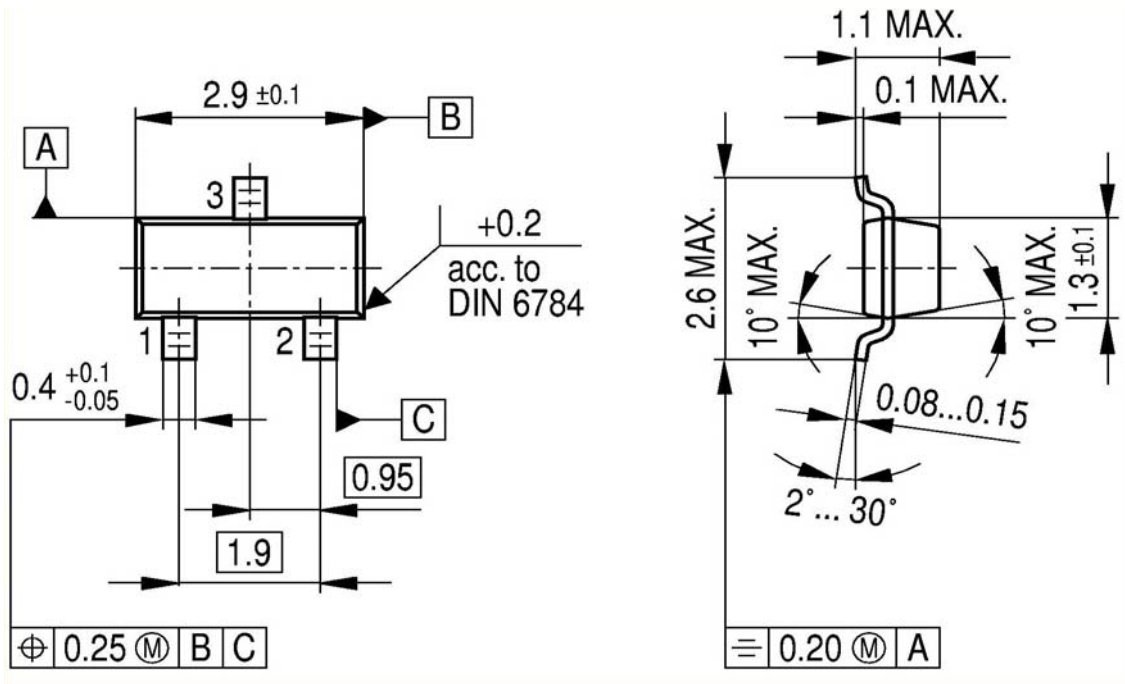

Footprint:

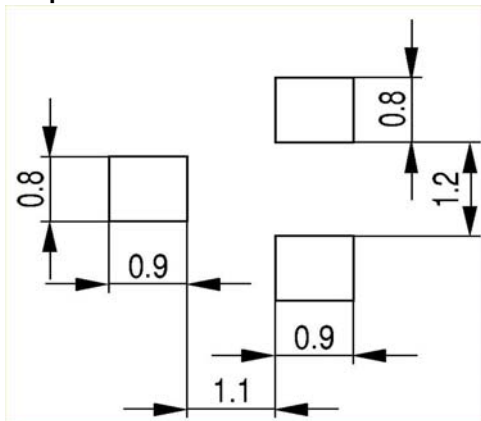

Packaging:

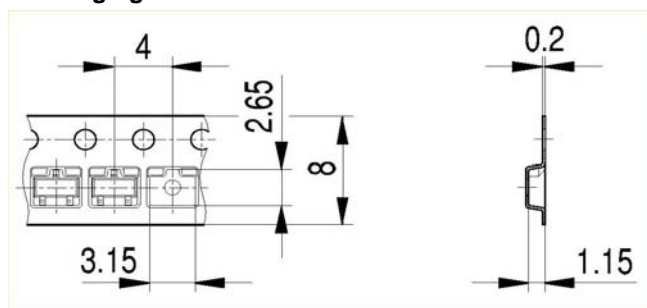

Published by
Infineon Technologies AG
81726 Munich, Germany
© 2008 Infineon Technologies AG
All Rights Reserved.

Legal Disclaimer

The information given in this document shall in no event be regarded as a guarantee of conditions or characteristics. With respect to any examples or hints given herein, any typical values stated herein and/or any information regarding the application of the device, Infineon Technologies hereby disclaims any and all warranties and liabilities of any kind, including without limitation, warranties of non-infringement of intellectual property rights of any third party.

Information

For further information on technology, delivery terms and conditions and prices, please contact the nearest Infineon Technologies Office (www.infineon.com).

Warnings

Due to technical requirements, components may contain dangerous substances. For information on the types in question, please contact the nearest Infineon Technologies Office. Infineon Technologies components may be used in life-support devices or systems only with the express written approval of Infineon Technologies, if a failure of such components can reasonably be expected to cause the failure of that life-support device or system or to affect the safety or effectiveness of that device or system. Life support devices or systems are intended to be implanted in the human body or to support and/or maintain and sustain and/or protect human life. If they fail, it is reasonable to assume that the health of the user or other persons may be endangered.

Mouser Electronics

Authorized Distributor

Click to View Pricing, Inventory, Delivery & Lifecycle Information:

[Infineon:](#)

[BSS315PH6327XTSA1](#)