

MIC4451/52

Functional Block Diagram

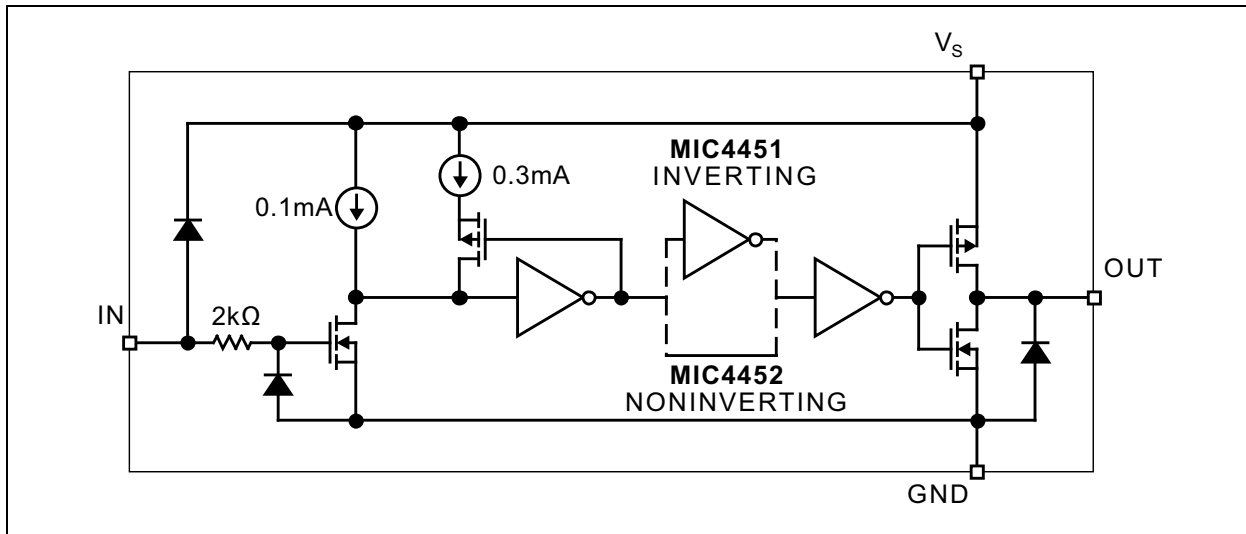

1.0 ELECTRICAL CHARACTERISTICS

Absolute Maximum Ratings †

Supply Voltage	+20V
Input Voltage	$V_S + 0.3V$ to GND – 5V
Input Current ($V_{IN} > V_S$)	5 mA
Power Dissipation ($T_A \leq 25^\circ\text{C}$)	
PDIP	960 mW
SOIC	1040 mW
TO-220	2W
Power Dissipation ($T_{CASE} \leq 25^\circ\text{C}$)	
TO-220	12.5W
Derating Factors (to Ambient)	
PDIP	7.7 mW/°C
SOIC	8.3 mW/°C
TO-220	17 mW/°C

† **Notice:** Stresses above those listed under “Absolute Maximum Ratings” may cause permanent damage to the device. This is a stress rating only and functional operation of the device at those or any other conditions above those indicated in the operational sections of this specification is not intended. Exposure to maximum rating conditions for extended periods may affect device reliability. Static-sensitive device. Store only in conductive containers. Handling personnel and equipment should be grounded to prevent damage from static discharge.

ELECTRICAL CHARACTERISTICS

Electrical Characteristics: $T_A = +25^\circ\text{C}$, with $4.5V \leq V_S \leq 18V$ unless otherwise specified.

Parameter	Symbol	Min.	Typ.	Max.	Units	Conditions
Input						
Logic 1 Input Voltage	V_{IH}	2.4	1.3	—	V	—
Logic 0 Input Voltage	V_{IL}	—	1.1	0.8	V	—
Input Voltage Range	V_{IN}	–5	—	$V_S + 0.3$	V	—
Input Current	I_{IN}	–10	—	10	μA	$0V \leq V_{IN} \leq V_S$
Output						
High Output Voltage	V_{OH}	$V_S - 0.025$	—	—	V	See Figure 1-1 .
Low Output Voltage	V_{OL}	—	—	0.025	V	See Figure 1-1 .
Output Resistance, Output High	R_O	—	0.6	1.5	Ω	$I_{OUT} = 10 \text{ mA}$, $V_S = 18V$
Output Resistance, Output Low	R_O	—	0.8	1.5	Ω	$I_{OUT} = 10 \text{ mA}$, $V_S = 18V$
Peak Output Current	I_{PK}	—	12	—	A	$V_S = 18V$, see Figure 1-3
Continuous Output Current	I_{DC}	2	—	—	A	—
Latch-up Protection Withstand Reverse Current	I_R	>1500	—	—	mA	Duty Cycle $\leq 2\%$, $t \leq 300 \mu\text{s}$
Switching Time (Note 1)						
Rise Time	t_R	—	20	40	ns	See Figure 1-1 . $C_L = 15,000 \text{ pF}$
Fall Time	t_F	—	24	50	ns	See Figure 1-1 . $C_L = 15,000 \text{ pF}$
Delay Time	t_{D1}	—	25	50	ns	See Figure 1-1 .
Delay Time	t_{D2}	—	40	60	ns	See Figure 1-1 .

MIC4451/52

ELECTRICAL CHARACTERISTICS (CONTINUED)

Electrical Characteristics: $T_A = +25^\circ\text{C}$, with $4.5\text{V} \leq V_S \leq 18\text{V}$ unless otherwise specified.

Parameter	Symbol	Min.	Typ.	Max.	Units	Conditions
Power Supply						
Power Supply Current	I_S	—	0.4	1.5	mA	$V_{IN} = 3\text{V}$
		—	80	150	μA	$V_{IN} = 0\text{V}$
Operating Input Voltage	V_S	4.5	—	18	V	—

Note 1: Specification for packaged product only.

ELECTRICAL CHARACTERISTICS

Electrical Characteristics: Over operating temperature range with $4.5\text{V} \leq V_S \leq 18\text{V}$ unless otherwise specified.

Parameter	Symbol	Min.	Typ.	Max.	Units	Conditions
Input						
Logic 1 Input Voltage	V_{IH}	2.4	—	—	V	—
Logic 0 Input Voltage	V_{IL}	—	—	0.8	V	—
Input Voltage Range	V_{IN}	-5	—	$V_S + 0.3$	V	—
Input Current	I_{IN}	-10	—	10	μA	$0\text{V} \leq V_{IN} \leq V_S$
Output						
High Output Voltage	V_{OH}	$V_S - 0.025$	—	—	V	See Figure 1-1 .
Low Output Voltage	V_{OL}	—	—	0.025	V	See Figure 1-1 .
Output Resistance, Output High	R_O	—	—	2.2	Ω	$I_{OUT} = 10\text{ mA}$, $V_S = 18\text{V}$
Output Resistance, Output Low	R_O	—	—	2.2	Ω	$I_{OUT} = 10\text{ mA}$, $V_S = 18\text{V}$
Switching Time (Note 1)						
Rise Time	t_R	—	—	50	ns	See Figure 1-1 . $C_L = 15,000\text{ pF}$
Fall Time	t_F	—	—	60	ns	See Figure 1-1 . $C_L = 15,000\text{ pF}$
Delay Time	t_{D1}	—	—	65	ns	See Figure 1-1 .
Delay Time	t_{D2}	—	—	80	ns	See Figure 1-1 .
Power Supply						
Power Supply Current	I_S	—	—	3	mA	$V_{IN} = 3\text{V}$
		—	—	0.4		$V_{IN} = 0\text{V}$
Operating Input Voltage	V_S	4.5	—	18	V	—

Note 1: Specification for packaged product only.

TEMPERATURE SPECIFICATIONS (Note 1)

Parameters	Sym.	Min.	Typ.	Max.	Units	Conditions
Temperature Ranges						
Ambient Operating Temperature Range	T_A	0	—	+70	°C	Z Ordering Option
		-40	—	+85	°C	Y Ordering Option
		-40	—	+125	°C	V Ordering Option
Storage Temperature Range	T_S	-65	—	+150	°C	—
Chip Operating Temperature	—	—	—	+150	°C	—
Lead Temperature	—	—	—	+300	°C	Soldering, 10 sec.
Package Thermal Resistance						
Thermal Resistance, TO-220 5-Ld	θ_{JC}	—	10	—	°C/W	—

Note 1: The maximum allowable power dissipation is a function of ambient temperature, the maximum allowable junction temperature and the thermal resistance from junction to air (i.e., T_A , T_J , θ_{JA}). Exceeding the maximum allowable power dissipation will cause the device operating junction temperature to exceed the maximum +125°C rating. Sustained junction temperatures above +125°C can impact the device reliability.

Test Circuits

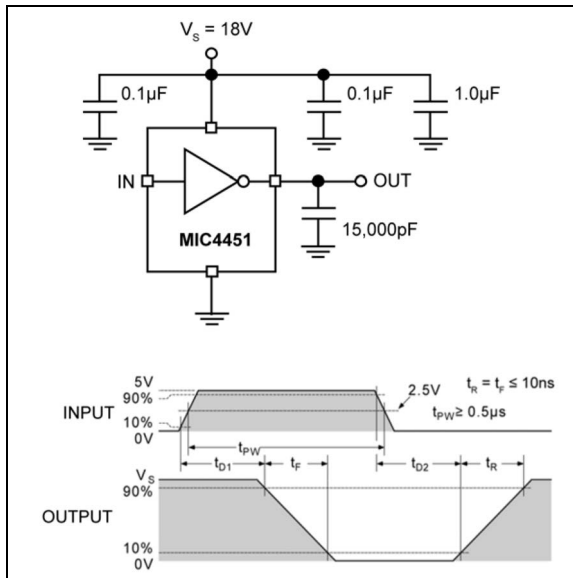

FIGURE 1-1: Inverting Driver Switching Time.

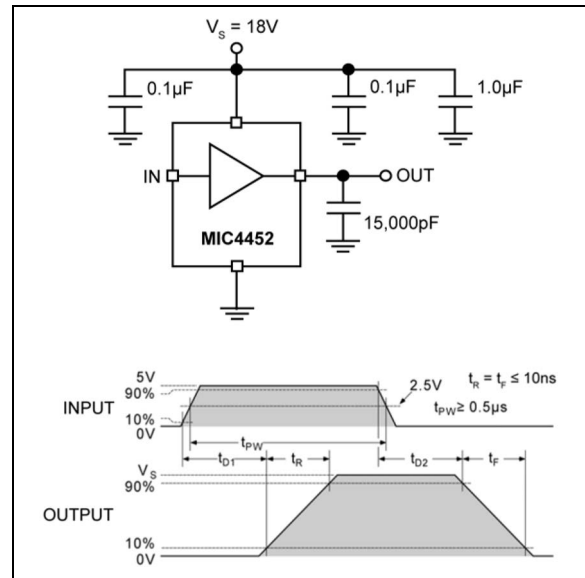

FIGURE 1-2: Non-Inverting Driver Switching Time.

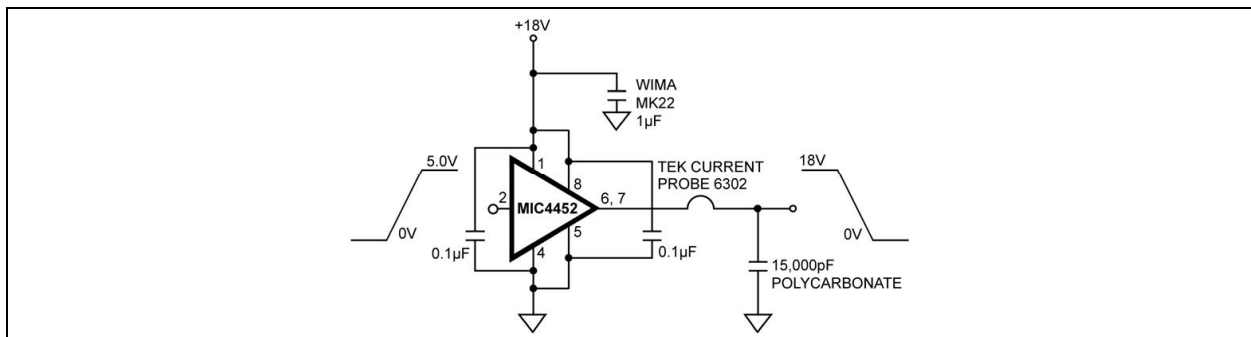

FIGURE 1-3: Peak Output Current Test Circuit.

MIC4451/52

2.0 TYPICAL PERFORMANCE CURVES

Note: The graphs and tables provided following this note are a statistical summary based on a limited number of samples and are provided for informational purposes only. The performance characteristics listed herein are not tested or guaranteed. In some graphs or tables, the data presented may be outside the specified operating range (e.g., outside specified power supply range) and therefore outside the warranted range.

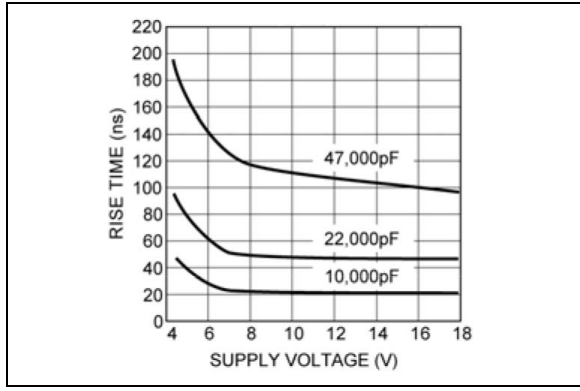

FIGURE 2-1: Rise Time vs. Supply Voltage.

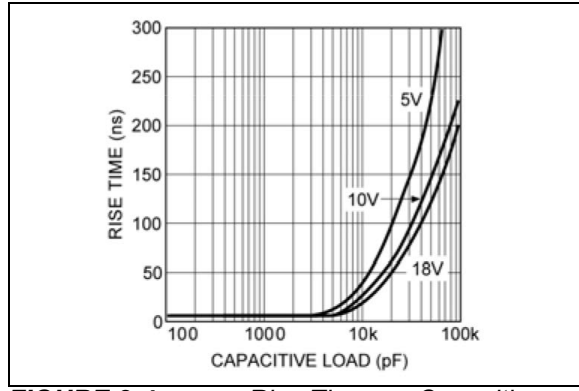

FIGURE 2-4: Rise Time vs. Capacitive Load.

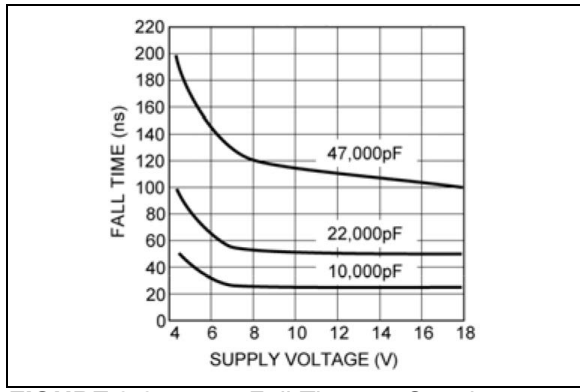

FIGURE 2-2: Fall Time vs. Supply Voltage.

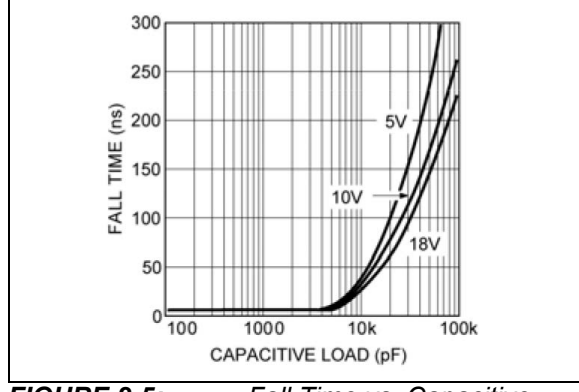

FIGURE 2-5: Fall Time vs. Capacitive Load.

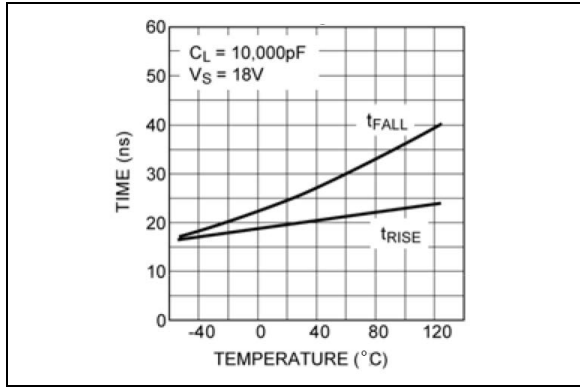

FIGURE 2-3: Rise and Fall Times vs. Temperature.

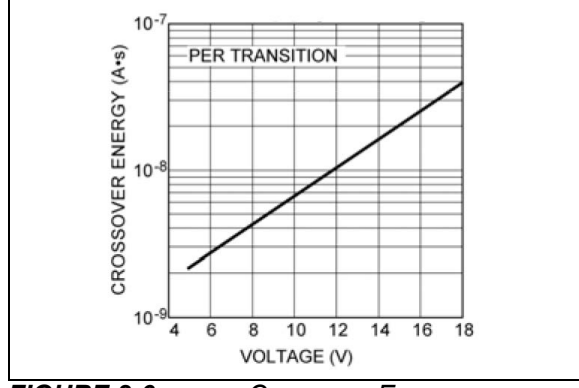

FIGURE 2-6: Crossover Energy vs. Supply Voltage.

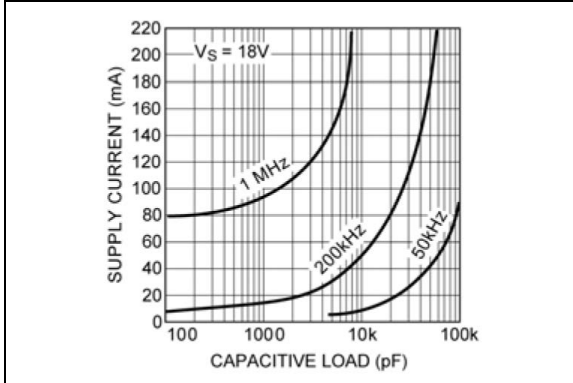

FIGURE 2-7: Supply Current vs. Capacitive Load.

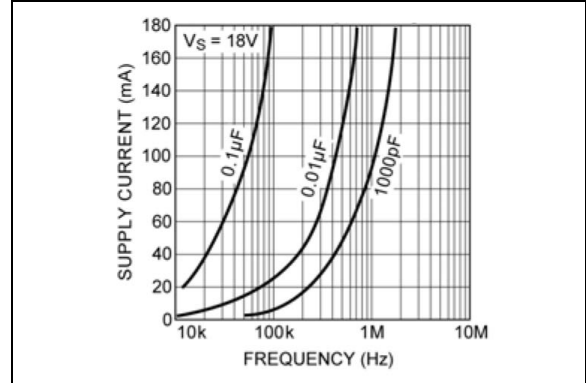

FIGURE 2-10: Supply Current vs. Frequency.

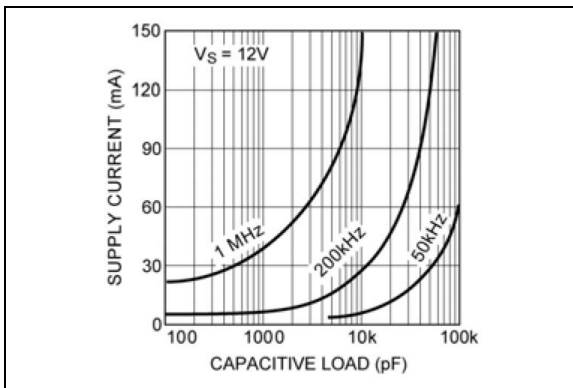

FIGURE 2-8: Supply Current vs. Capacitive Load.

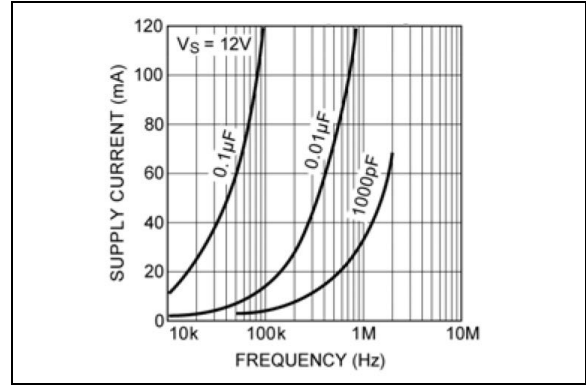

FIGURE 2-11: Supply Current vs. Frequency.

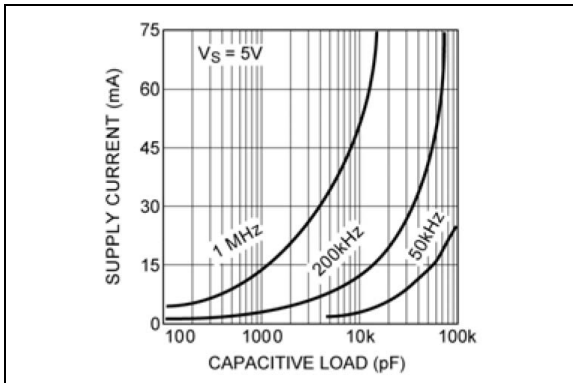

FIGURE 2-9: Supply Current vs. Capacitive Load.

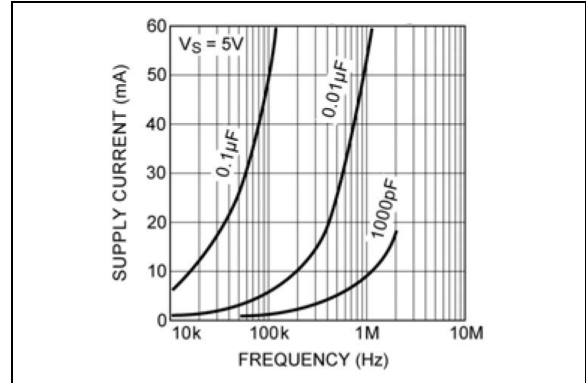

FIGURE 2-12: Supply Current vs. Frequency.

MIC4451/52

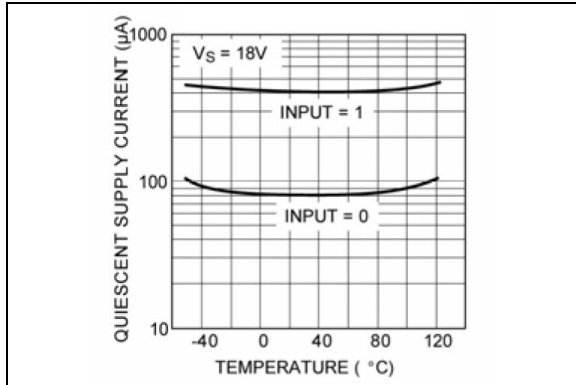

FIGURE 2-13: Quiescent Supply Current vs. Temperature.

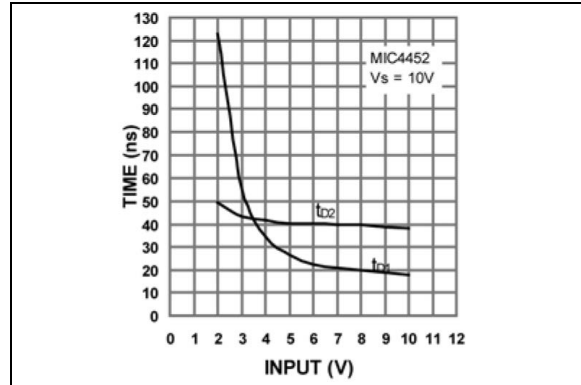

FIGURE 2-16: Propagation Delay vs. Input Amplitude.

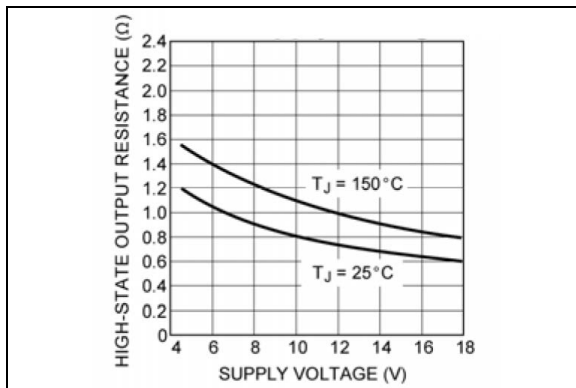

FIGURE 2-14: High-State Output Resistance vs. Supply Voltage.

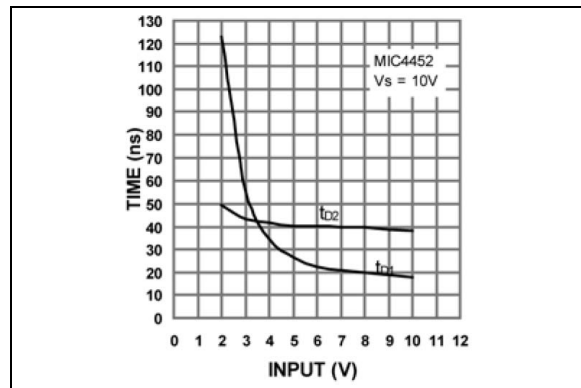

FIGURE 2-17: Propagation Delay vs. Input Amplitude.

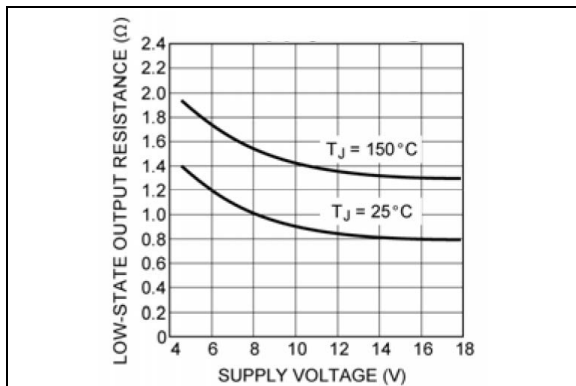

FIGURE 2-15: Low-State Output Resistance vs. Supply Voltage.

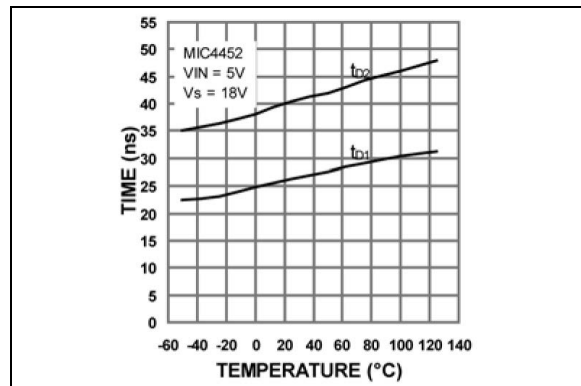

FIGURE 2-18: Propagation Delay vs. Input Temperature.

3.0 PIN DESCRIPTIONS

The descriptions of the pins are listed in [Table 3-1](#).

TABLE 3-1: PIN FUNCTION TABLE

Pin Number TO-220	Pin Number SOIC/PDIP	Pin Name	Description
1	2	IN	Control Input.
2, 4	4, 5	GND	Ground: Duplicate Pins must be externally connected together.
3, TAB	1, 8	VS	Supply Input: Duplicate pins must be externally connected together.
5	6, 7	OUT	Output: Duplicate pins must be externally connected together.
—	3	NC	Not Connected.

4.0 APPLICATIONS INFORMATION

4.1 Supply Bypassing

Charging and discharging large capacitive loads quickly requires large currents. For example, changing a 10,000 pF load to 18V in 50 ns requires 3.6A.

The MIC4451 and MIC4452 have double bonding on the supply pins, the ground pins, and output pins. This reduces parasitic lead inductance. Low inductance enables large currents to be switched rapidly. It also reduces internal ringing that can cause voltage breakdown when the driver is operated at or near the maximum rated voltage.

Internal ringing can also cause output oscillation due to feedback. This feedback is added to the input signal because it is referenced to the same ground.

To ensure low supply impedance over a wide frequency range, a parallel capacitor combination is recommended for supply bypassing. Low inductance ceramic disc capacitors with short lead lengths (<0.5 inch) should be used. A 1 μ F low ESR film capacitor in parallel with two 0.1 μ F low ESR ceramic capacitors, (such as AVX RAM GUARD[®]), provides adequate bypassing. Connect one ceramic capacitor directly between pins 1 and 4. Connect the second ceramic capacitor directly between pins 8 and 5.

4.2 Grounding

The high current capability of the MIC4451/52 demands careful PC board layout for best performance. Because the MIC4451 is an inverting driver, any ground lead impedance will appear as negative feedback which can degrade switching speed. Feedback is especially noticeable with slow rise time inputs. The MIC4451 input structure includes 200 mV of hysteresis to ensure clean transitions and freedom from oscillation, but attention to layout is still recommended.

Figure 4-1 shows the feedback effect in detail. As the MIC4451 input begins to go positive, the output goes negative and several amperes of current flow in the ground lead. As little as 0.05 Ω of PC trace resistance can produce hundreds of millivolts at the MIC4451 ground pins. If the driving logic is referenced to power ground, the effective logic input level is reduced and oscillation may result.

To ensure optimum performance, separate ground traces should be provided for the logic and power connections. Connecting the logic ground directly to the MIC4451 GND pins will ensure full logic drive to the input and ensure fast output switching. Both of the MIC4451 GND pins should, however, still be connected to power ground.

4.3 Input Stage

The input voltage level of the MIC4451 changes the quiescent supply current. The N-channel MOSFET input stage transistor drives a 320 μ A current source load. With a logic “1” input, the maximum quiescent supply current is 400 μ A. Logic “0” input level signals reduce quiescent current to 80 μ A typical.

The MIC4451/52 input is designed to provide 200 mV of hysteresis. This provides clean transitions, reduces noise sensitivity, and minimizes output stage current spiking when changing states. Input voltage threshold level is approximately 1.5V, making the device TTL-compatible over the full temperature and operating supply voltage ranges. Input current is less than ± 10 μ A.

The MIC4451 can be directly driven by the TL494, SG1526/1527, SG1524, TSC170, MIC38C42, and similar switch mode power supply integrated circuits. By offloading the power-driving duties to the MIC4451/52, the power supply controller can operate at lower dissipation. This can improve performance and reliability.

The input can be greater than the V_S supply, however, current will flow into the input lead. The input currents can be as high as 30 mA peak-to-peak (6.4 mA_{RMS}) with the input. No damage will occur to MIC4451/52, however, and it will not latch.

The input appears as a 7 pF capacitance and does not change even if the input is driven from an AC source. While the device will operate and no damage will occur up to 25V below the negative rail, input current will increase up to 1 mA/V due to the clamping action of the input, ESD diode, and 1 k Ω resistor.

4.4 Power Dissipation

CMOS circuits usually permit the user to ignore power dissipation. Logic families, such as 4000 and 74C, have outputs that can only supply a few milliamperes of current, and even shorting outputs to ground will not force enough current to destroy the device. The MIC4451/52 on the other hand, can source or sink several amperes and drive large capacitive loads at high frequency. The package power dissipation limit can easily be exceeded. Therefore, some attention should be given to power dissipation when driving low impedance loads and/or operating at high frequency.

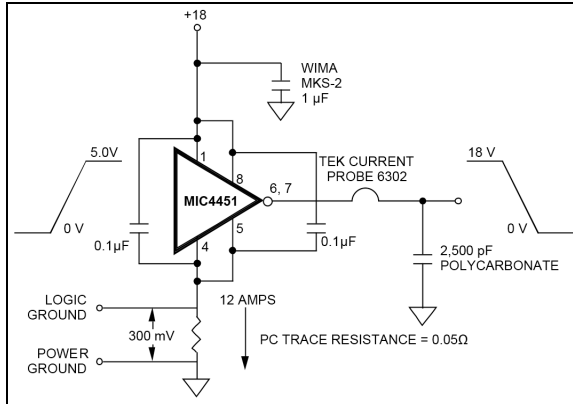

FIGURE 4-1: Switching Time Degradation Due to Negative Feedback.

The supply current vs. frequency and supply current vs. capacitive load characteristic curves aid in determining power dissipation calculations. Table 4-1 lists the maximum safe operating frequency for several power supply voltages when driving a 10,000 pF load. More accurate power dissipation figures can be obtained by summing the three dissipation sources.

Given the power dissipation in the device and the thermal resistance of the package, junction operating temperature for any ambient is easy to calculate. For example, the thermal resistance of the 8-lead plastic DIP package, from the data sheet, is 130°C/W. In a 25°C ambient, then, using a maximum junction temperature of 125°C, this package will dissipate 960 mW.

Accurate power dissipation numbers can be obtained by summing the three sources of power dissipation in the device:

- Load Power Dissipation (P_L)
- Quiescent power dissipation (P_Q)
- Transition power dissipation (P_T)

Calculation of load power dissipation differs depending on whether the load is capacitive, resistive or inductive.

4.5 Resistive Load Power Dissipation

Dissipation caused by a resistive load can be calculated as:

EQUATION 4-1:

$$P_L = I^2 \times R_O \times D$$

Where:

I = The current drawn by the load.
 R_O = The output resistance of the driver when the output is high, at the power supply voltage used.
 D = The fraction of time the load is conducting (duty cycle).

4.6 Capacitive Load Power Dissipation

Dissipation caused by a capacitive load is simply the energy placed in, or removed from, the load capacitance by the driver. The energy stored in a capacitor is described by the equation:

EQUATION 4-2:

$$E = \frac{1}{2} \times C \times V^2$$

TABLE 4-1: MIC4451 MAX. OPERATION FREQUENCY

V_S	Max. Frequency
18V	220 kHz
15V	300 kHz
10V	640 kHz
5V	2 MHz

Because this energy is lost in the driver each time the load is charged or discharged, the "1/2" is removed for power dissipation calculations. This equation also shows that it is good practice not to place more voltage on the capacitor than is necessary, as dissipation increases as the square of the voltage applied to the capacitor. For a driver with a capacitive load:

EQUATION 4-3:

$$P_L = f \times C \times (V_S)^2$$

Where:

f = Operating frequency.
 C = Load capacitance.
 V_S = Driver supply voltage.

4.7 Inductive Load Power Dissipation

For inductive loads, the situation is more complicated. For the part of the cycle in which the driver is actively forcing current into the inductor, the situation is the same as it is in the resistive case:

EQUATION 4-4:

$$P_{L1} = I^2 \times R_O \times D$$

MIC4451/52

In this instance, however, the R_O required may be either the ON resistance of the driver when its output is in the high state, or its ON resistance when the driver is in the low state, depending on how the inductor is connected, and this is still only half the story. For the part of the cycle when the inductor is forcing current through the driver, dissipation is best described as:

EQUATION 4-5:

$$P_{L2} = I \times V_D \times (1 - D)$$

Where:

V_D = The forward drop of the clamp diode in the driver (generally around 0.7V).

The two parts of the load dissipation must be summed in to produce P_L :

EQUATION 4-6:

$$P_L = P_{L1} + P_{L2}$$

4.8 Quiescent Power Dissipation

Quiescent power dissipation (P_Q , as described in the input section) depends on whether the input is high or low. A low input will result in a maximum current drain (per driver) of ≤ 0.2 mA; a logic high will result in a current drain of ≤ 3.0 mA. Quiescent power can therefore be derived from:

EQUATION 4-7:

$$P_Q = V_S \times [D \times I_H + (1 - D) \times I_L]$$

Where:

I_H = Quiescent current with input high.

I_L = Quiescent current with input low.

D = Fraction of time the input is high (duty cycle).

V_S = Power supply voltage.

4.9 Transition Power Dissipation

Transition power is dissipated in the driver each time its output changes state because during the transition, for a very brief interval, both the N- and P-channel MOSFETs in the output totem-pole are ON simultaneously and a current is conducted through them from V_S to ground. The transition power dissipation is approximately:

EQUATION 4-8:

$$P_T = 2 \times f \times V_S \times (A \times s)$$

Where:

($A \times s$) = A time-current factor derived from [Figure 2-6](#)

Total power (P_D) then, as previously described is:

EQUATION 4-9:

$$P_D = P_L + P_Q + P_T$$

4.10 Definitions

C_L = Load Capacitance in Farads.

D = Duty Cycle expressed as the fraction of time the input to the driver is high.

f = Operating Frequency of the driver in Hertz

I_H = Power supply current drawn by a driver when both inputs are high and neither output is loaded.

I_L = Power supply current drawn by a driver when both inputs are low and neither output is loaded.

I_D = Output current from a driver in Amps.

P_D = Total power dissipated in a driver in Watts.

P_L = Power dissipated in the driver due to the driver's load in Watts.

P_Q = Power dissipated in a quiescent driver in Watts.

P_T = Power dissipated in a driver when the output changes states (shoot-through current) in watts.

R_O = Output resistance of a driver in Ohms.

V_S = Power supply voltage to the IC in volts.

5.0 PACKAGING INFORMATION

5.1 Package Marking Information

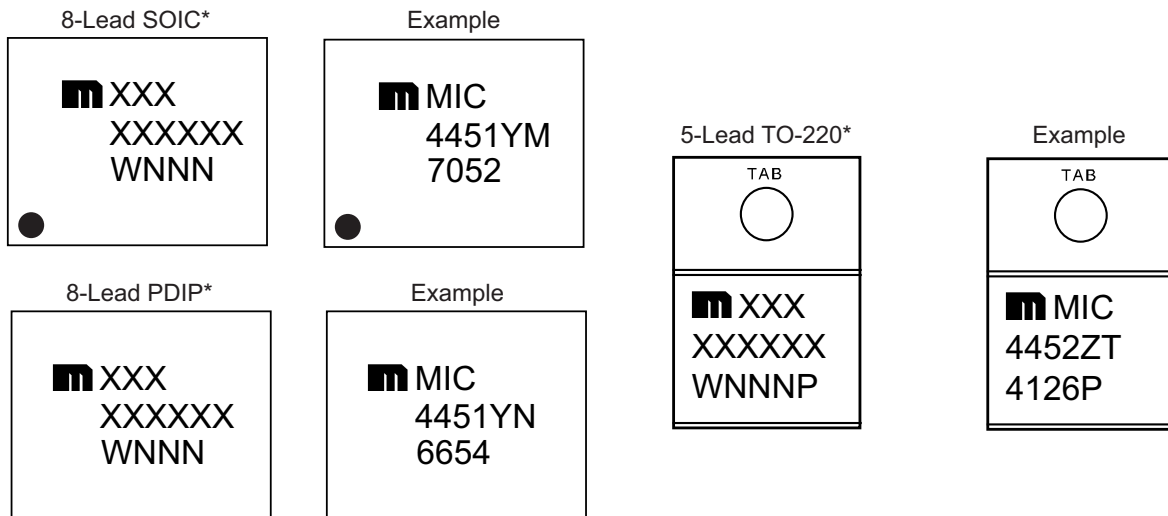

Legend:	XX...X	Product code or customer-specific information
	Y	Year code (last digit of calendar year)
	YY	Year code (last 2 digits of calendar year)
	WW	Week code (week of January 1 is week '01')
	NNN	Alphanumeric traceability code
	(e3)	Pb-free JEDEC® designator for Matte Tin (Sn)
	*	This package is Pb-free. The Pb-free JEDEC designator (e3) can be found on the outer packaging for this package.
	•, ▲, ▼	Pin one index is identified by a dot, delta up, or delta down (triangle mark).
Note:	In the event the full Microchip part number cannot be marked on one line, it will be carried over to the next line, thus limiting the number of available characters for customer-specific information. Package may or may not include the corporate logo.	
	Underbar (¯) and/or Overbar (¯) symbol may not be to scale.	

MIC4451/52

8-Lead SOIC Package Outline and Recommended Land Pattern

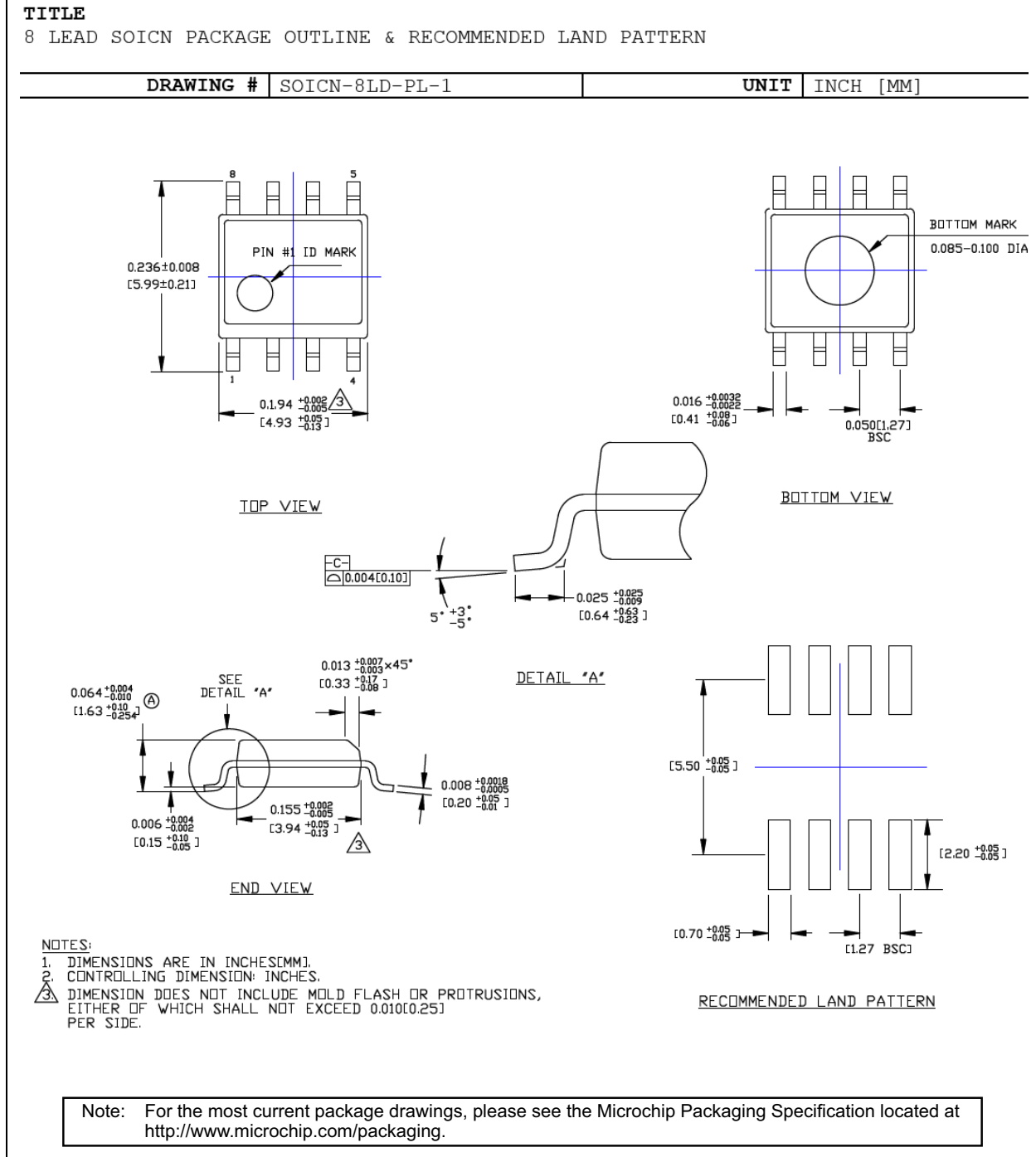

8-Lead PDIP Package Outline and Recommended Land Pattern

TITLE

8 LEAD PDIP PACKAGE OUTLINE & RECOMMENDED LAND PATTERN

DRAWING #	PDIP-8LD-PL-1	UNIT	INCH
Lead Frame	Copper	Lead Finish	Matte Tin

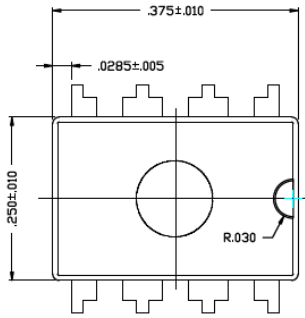

TOP VIEW

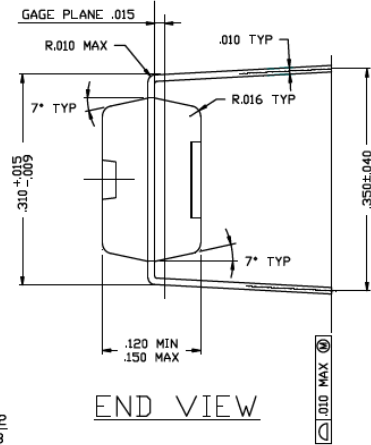

END VIEW

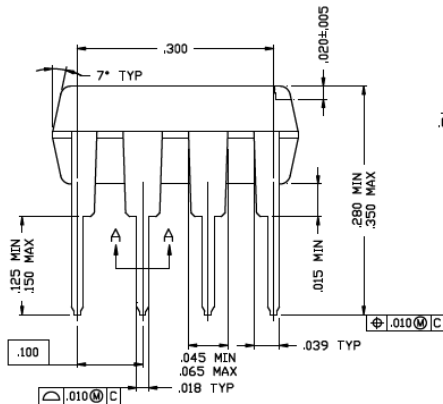

SIDE VIEW

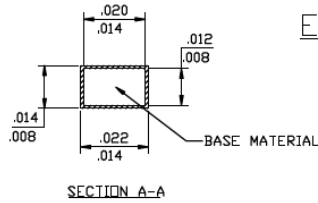

SECTION A-A

Note: For the most current package drawings, please see the Microchip Packaging Specification located at <http://www.microchip.com/packaging>.

MIC4451/52

5-Lead TO-220 Package Outline and Recommended Land Pattern

5-Lead Transistor Outline Type LB03 (B8X) - [TO-220] Micrel Legacy Package TO220-LB03-5LD-PL-1

Note: For the most current package drawings, please see the Microchip Packaging Specification located at <http://www.microchip.com/packaging>

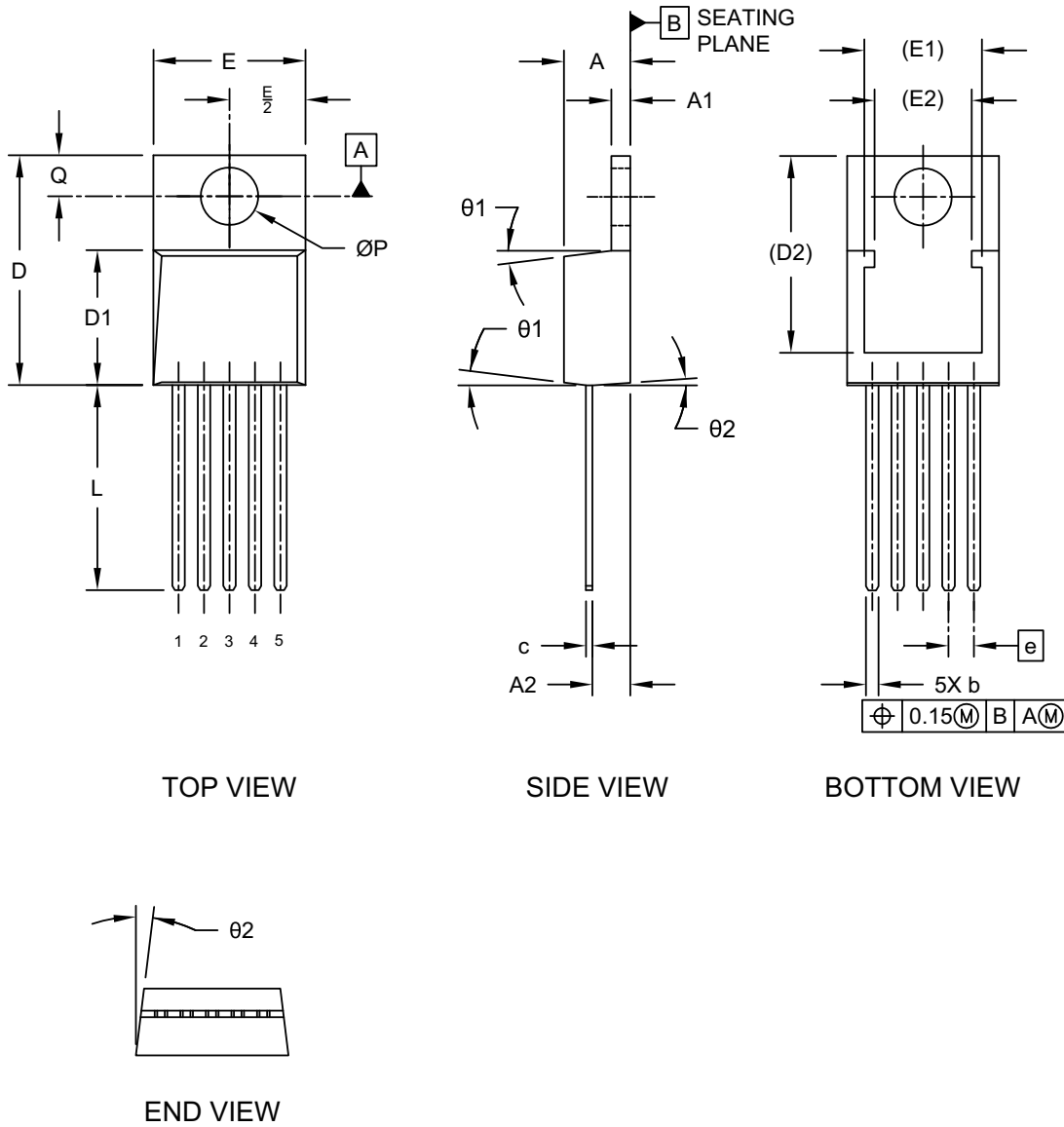

Microchip Technology Drawing C04-036 Rev D Sheet 1 of 2

5-Lead Transistor Outline Type LB03 (B8X) - [TO-220] Micrel Legacy Package TO220-LB03-5LD-PL-1

Note: For the most current package drawings, please see the Microchip Packaging Specification located at <http://www.microchip.com/packaging>

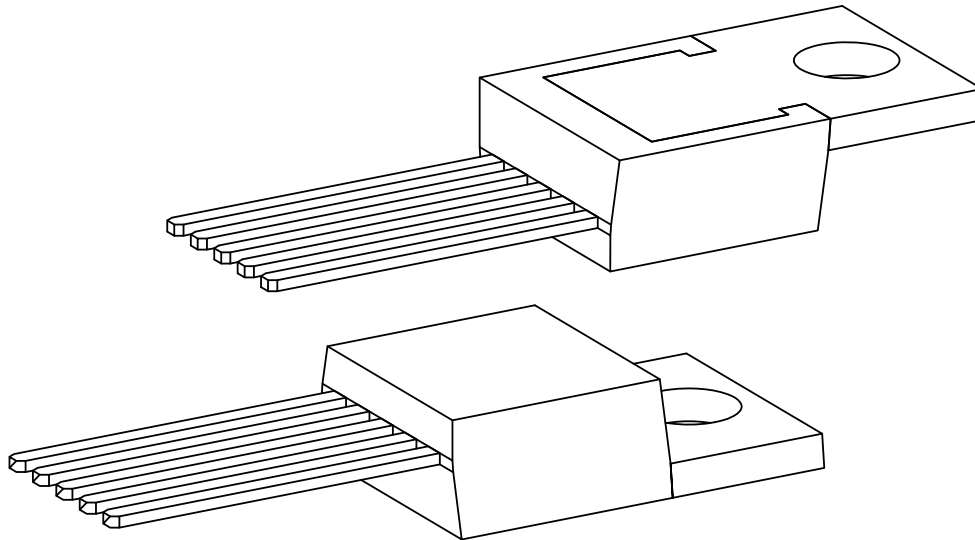

Dimension Limits		INCHES		
		Min	Nom	Max
Number of Leads	N	5		
Pitch	e	.067 BSC		
Overall Height	A	.160	.175	.190
Tab Height	A1	.045	.050	.055
Seating Plane to Lead	A2	.080	.098	.115
Lead Width	b	.025	.033	.040
Lead Thickness	c	.012	.016	.020
Lead Length	L	.500	.540	.580
Total Body Length Including Tab	D	.542	.580	.619
Molded Body Length	D1	.348	.354	.360
Total Width	E	.380	.400	.420
Pad Width	E1	0.256 REF		
Pad Length	D2	0.486 REF		
Hole Diameter	ØP	.146	.151	.156
Hole Center to Tab Edge	Q	.103	.108	.113
Molded Body Draft Angle	θ1	3	7	10
Molded Body Draft Angle	θ2	1	4	7

Notes:

- Pin 1 visual index feature may vary, but must be located within the hatched area.
- Dimensioning and tolerancing per ASME Y14.5M
BSC: Basic Dimension. Theoretically exact value shown without tolerances.
REF: Reference Dimension, usually without tolerance, for information purposes only.

Microchip Technology Drawing C04-036 Rev D Sheet 2 of 2

MIC4451/52

NOTES:

APPENDIX A: REVISION HISTORY

Revision A (November 2021)

- Converted Micrel document MIC4451/52 to Microchip data sheet DS20006616A.
- Minor text changes throughout.

MIC4451/52

NOTES:

PRODUCT IDENTIFICATION SYSTEM

To order or obtain information, e.g., on pricing or delivery, contact your local Microchip representative or sales office.

<u>PART No.</u>	<u>X</u>	<u>X</u>	<u>-XX</u>	Examples:
Device	Junction Temp. Range	Package	Media Type	
Device:	MIC4451:	Inverting 12A Peak Low-Side MOSFET Driver		a) MIC4451YN: MIC4451, -40°C to +85°C Temperature Range, 8-Lead PDIP, 50/Tube
	MIC4452:	Non-Inverting 12A Peak Low-Side MOSFET Driver		b) MIC4451YM: MIC4451, -40°C to +85°C Temperature Range, 8-Lead SOIC, 95/Tube
Junction Temperature Range:	V =	-40°C to +125°C (MIC4452 Only)		c) MIC4451YM-TR: MIC4451, -40°C to +85°C Temperature Range, 8-Lead SOIC, 2,500/Reel
	Y =	-40°C to +85°C		d) MIC4451ZT: MIC4451, 0°C to +70°C Temperature Range, 5-Lead TO-220, 50/Tube
	Z =	0°C to +70°C		e) MIC4452YN: MIC4452, -40°C to +85°C Temperature Range, 8-Lead PDIP, 50/Tube
Package:	M =	8-Lead SOIC		f) MIC4452YM: MIC4452, -40°C to +85°C Temperature Range, 8-Lead SOIC, 95/Tube
	N =	8-Lead PDIP		g) MIC4452YM-TR: MIC4452, -40°C to +85°C Temperature Range, 8-Lead SOIC, 2,500/Reel
	T =	5-Lead TO-220		h) MIC4452ZT: MIC4452, 0°C to +70°C Temperature Range, 5-Lead TO-220, 50/Tube
Media Type:	<blank> =	50/Tube (TO-220 and PDIP Only)		i) MIC4452VM: MIC4452, -40°C to +125°C Temperature Range, 8-Lead SOIC, 95/Tube
	<blank> =	95/Tube (SOIC Only)		j) MIC4452VM-TR: MIC4452, -40°C to +125°C Temperature Range, 8-Lead SOIC, 2,500/Reel
	TR =	2,500/Reel (SOIC Only)		Note 1: Tape and Reel identifier only appears in the catalog part number description. This identifier is used for ordering purposes and is not printed on the device package. Check with your Microchip Sales Office for package availability with the Tape and Reel option.

MIC4451/52

NOTES:

Note the following details of the code protection feature on Microchip products:

- Microchip products meet the specifications contained in their particular Microchip Data Sheet.
- Microchip believes that its family of products is secure when used in the intended manner, within operating specifications, and under normal conditions.
- Microchip values and aggressively protects its intellectual property rights. Attempts to breach the code protection features of Microchip product is strictly prohibited and may violate the Digital Millennium Copyright Act.
- Neither Microchip nor any other semiconductor manufacturer can guarantee the security of its code. Code protection does not mean that we are guaranteeing the product is “unbreakable”. Code protection is constantly evolving. Microchip is committed to continuously improving the code protection features of our products.

This publication and the information herein may be used only with Microchip products, including to design, test, and integrate Microchip products with your application. Use of this information in any other manner violates these terms. Information regarding device applications is provided only for your convenience and may be superseded by updates. It is your responsibility to ensure that your application meets with your specifications. Contact your local Microchip sales office for additional support or, obtain additional support at <https://www.microchip.com/en-us/support/design-help/client-support-services>.

THIS INFORMATION IS PROVIDED BY MICROCHIP "AS IS". MICROCHIP MAKES NO REPRESENTATIONS OR WARRANTIES OF ANY KIND WHETHER EXPRESS OR IMPLIED, WRITTEN OR ORAL, STATUTORY OR OTHERWISE, RELATED TO THE INFORMATION INCLUDING BUT NOT LIMITED TO ANY IMPLIED WARRANTIES OF NON-INFRINGEMENT, MERCHANTABILITY, AND FITNESS FOR A PARTICULAR PURPOSE, OR WARRANTIES RELATED TO ITS CONDITION, QUALITY, OR PERFORMANCE.

IN NO EVENT WILL MICROCHIP BE LIABLE FOR ANY INDIRECT, SPECIAL, PUNITIVE, INCIDENTAL, OR CONSEQUENTIAL LOSS, DAMAGE, COST, OR EXPENSE OF ANY KIND WHATSOEVER RELATED TO THE INFORMATION OR ITS USE, HOWEVER CAUSED, EVEN IF MICROCHIP HAS BEEN ADVISED OF THE POSSIBILITY OR THE DAMAGES ARE FORESEEABLE. TO THE FULLEST EXTENT ALLOWED BY LAW, MICROCHIP'S TOTAL LIABILITY ON ALL CLAIMS IN ANY WAY RELATED TO THE INFORMATION OR ITS USE WILL NOT EXCEED THE AMOUNT OF FEES, IF ANY, THAT YOU HAVE PAID DIRECTLY TO MICROCHIP FOR THE INFORMATION.

Use of Microchip devices in life support and/or safety applications is entirely at the buyer's risk, and the buyer agrees to defend, indemnify and hold harmless Microchip from any and all damages, claims, suits, or expenses resulting from such use. No licenses are conveyed, implicitly or otherwise, under any Microchip intellectual property rights unless otherwise stated.

For information regarding Microchip's Quality Management Systems, please visit www.microchip.com/quality.

Trademarks

The Microchip name and logo, the Microchip logo, Adaptec, AnyRate, AVR, AVR logo, AVR Freaks, BesTime, BitCloud, CryptoMemory, CryptoRF, dsPIC, flexPWR, HELDO, IGLOO, JukeBlox, KeeLoq, Kleer, LANCheck, LinkMD, maXStylus, maXTouch, MediaLB, megaAVR, Microsemi, Microsemi logo, MOST, MOST logo, MPLAB, OptoLyzer, PIC, picoPower, PICSTART, PIC32 logo, PolarFire, Prochip Designer, QTouch, SAM-BA, SenGenuity, SpyNIC, SST, SST Logo, SuperFlash, Symmetricom, SyncServer, Tachyon, TimeSource, tinyAVR, UNI/O, Vectron, and XMEGA are registered trademarks of Microchip Technology Incorporated in the U.S.A. and other countries.

AgileSwitch, APT, ClockWorks, The Embedded Control Solutions Company, EtherSynch, Flashtec, Hyper Speed Control, HyperLight Load, IntelliMOS, Libero, motorBench, mTouch, Powermite 3, Precision Edge, ProASIC, ProASIC Plus, ProASIC Plus logo, QuietWire, SmartFusion, SyncWorld, Temux, TimeCesium, TimeHub, TimePictra, TimeProvider, TrueTime, WinPath, and ZL are registered trademarks of Microchip Technology Incorporated in the U.S.A.

Adjacent Key Suppression, AKS, Analog-for-the-Digital Age, Any Capacitor, AnyIn, AnyOut, Augmented Switching, BlueSky, BodyCom, CodeGuard, CryptoAuthentication, CryptoAutomotive, CryptoCompanion, CryptoController, dsPICDEM, dsPICDEM.net, Dynamic Average Matching, DAM, ECAN, Espresso T1S, EtherGREEN, GridTime, IdealBridge, In-Circuit Serial Programming, ICSP, INICnet, Intelligent Paralleling, Inter-Chip Connectivity, JitterBlocker, Knob-on-Display, maxCrypto, maxView, memBrain, Mindi, MiWi, MPASM, MPF, MPLAB Certified logo, MPLIB, MPLINK, MultiTRAK, NetDetach, NVM Express, NVMe, Omniscient Code Generation, PICDEM, PICDEM.net, PICkit, PICtail, PowerSmart, PureSilicon, QMatrix, REAL ICE, Ripple Blocker, RTAX, RTG4, SAM-ICE, Serial Quad I/O, simpleMAP, SimpliPHY, SmartBuffer, SmartHLS, SMART-I.S., storClad, SQI, SuperSwitcher, SuperSwitcher II, Switchtec, SynchroPHY, Total Endurance, TSHARC, USBCheck, VariSense, VectorBlox, VeriPHY, ViewSpan, WiperLock, XpressConnect, and ZENA are trademarks of Microchip Technology Incorporated in the U.S.A. and other countries.

SQTP is a service mark of Microchip Technology Incorporated in the U.S.A.

The Adaptec logo, Frequency on Demand, Silicon Storage Technology, Symmcom, and Trusted Time are registered trademarks of Microchip Technology Inc. in other countries.

GestIC is a registered trademark of Microchip Technology Germany II GmbH & Co. KG, a subsidiary of Microchip Technology Inc., in other countries.

All other trademarks mentioned herein are property of their respective companies.

© 2021, Microchip Technology Incorporated and its subsidiaries.

All Rights Reserved.

ISBN: 978-1-5224-9296-2



MICROCHIP

Worldwide Sales and Service

AMERICAS

Corporate Office
2355 West Chandler Blvd.
Chandler, AZ 85224-6199
Tel: 480-792-7200
Fax: 480-792-7277
Technical Support:
<http://www.microchip.com/support>
Web Address:
www.microchip.com

Atlanta

Duluth, GA
Tel: 678-957-9614
Fax: 678-957-1455

Austin, TX

Tel: 512-257-3370

Boston

Westborough, MA
Tel: 774-760-0087
Fax: 774-760-0088

Chicago

Itasca, IL
Tel: 630-285-0071
Fax: 630-285-0075

Dallas

Addison, TX
Tel: 972-818-7423
Fax: 972-818-2924

Detroit

Novi, MI
Tel: 248-848-4000

Houston, TX

Tel: 281-894-5983

Indianapolis

Noblesville, IN
Tel: 317-773-8323
Fax: 317-773-5453
Tel: 317-536-2380

Los Angeles

Mission Viejo, CA
Tel: 949-462-9523
Fax: 949-462-9608
Tel: 951-273-7800

Raleigh, NC

Tel: 919-844-7510

New York, NY

Tel: 631-435-6000

San Jose, CA

Tel: 408-735-9110
Tel: 408-436-4270

Canada - Toronto

Tel: 905-695-1980
Fax: 905-695-2078

ASIA/PACIFIC

Australia - Sydney
Tel: 61-2-9868-6733

China - Beijing
Tel: 86-10-8569-7000

China - Chengdu
Tel: 86-28-8665-5511

China - Chongqing
Tel: 86-23-8980-9588

China - Dongguan
Tel: 86-769-8702-9880

China - Guangzhou
Tel: 86-20-8755-8029

China - Hangzhou
Tel: 86-571-8792-8115

China - Hong Kong SAR
Tel: 852-2943-5100

China - Nanjing
Tel: 86-25-8473-2460

China - Qingdao
Tel: 86-532-8502-7355

China - Shanghai
Tel: 86-21-3326-8000

China - Shenyang
Tel: 86-24-2334-2829

China - Shenzhen
Tel: 86-755-8864-2200

China - Suzhou
Tel: 86-186-6233-1526

China - Wuhan
Tel: 86-27-5980-5300

China - Xian
Tel: 86-29-8833-7252

China - Xiamen
Tel: 86-592-2388138

China - Zhuhai
Tel: 86-756-3210040

ASIA/PACIFIC

India - Bangalore
Tel: 91-80-3090-4444

India - New Delhi
Tel: 91-11-4160-8631

India - Pune
Tel: 91-20-4121-0141

Japan - Osaka
Tel: 81-6-6152-7160

Japan - Tokyo
Tel: 81-3-6880-3770

Korea - Daegu
Tel: 82-53-744-4301

Korea - Seoul
Tel: 82-2-554-7200

Malaysia - Kuala Lumpur
Tel: 60-3-7651-7906

Malaysia - Penang
Tel: 60-4-227-8870

Philippines - Manila
Tel: 63-2-634-9065

Singapore
Tel: 65-6334-8870

Taiwan - Hsin Chu
Tel: 886-3-577-8366

Taiwan - Kaohsiung
Tel: 886-7-213-7830

Taiwan - Taipei
Tel: 886-2-2508-8600

Thailand - Bangkok
Tel: 66-2-694-1351

Vietnam - Ho Chi Minh
Tel: 84-28-5448-2100

EUROPE

Austria - Wels
Tel: 43-7242-2244-39
Fax: 43-7242-2244-393

Denmark - Copenhagen
Tel: 45-4485-5910
Fax: 45-4485-2829

Finland - Espoo
Tel: 358-9-4520-820

France - Paris
Tel: 33-1-69-53-63-20
Fax: 33-1-69-30-90-79

Germany - Garching
Tel: 49-8931-9700

Germany - Haan
Tel: 49-2129-3766400

Germany - Heilbronn
Tel: 49-7131-72400

Germany - Karlsruhe
Tel: 49-721-625370

Germany - Munich
Tel: 49-89-627-144-0
Fax: 49-89-627-144-44

Germany - Rosenheim
Tel: 49-8031-354-560

Israel - Ra'anana
Tel: 972-9-744-7705

Italy - Milan
Tel: 39-0331-742611
Fax: 39-0331-466781

Italy - Padova
Tel: 39-049-7625286

Netherlands - Drunen
Tel: 31-416-690399
Fax: 31-416-690340

Norway - Trondheim
Tel: 47-7288-4388

Poland - Warsaw
Tel: 48-22-3325737

Romania - Bucharest
Tel: 40-21-407-87-50

Spain - Madrid
Tel: 34-91-708-08-90
Fax: 34-91-708-08-91

Sweden - Gothenberg
Tel: 46-31-704-60-40

Sweden - Stockholm
Tel: 46-8-5090-4654

UK - Wokingham
Tel: 44-118-921-5800
Fax: 44-118-921-5820

Mouser Electronics

Authorized Distributor

Click to View Pricing, Inventory, Delivery & Lifecycle Information:

Microchip:

[MIC4451YM TR](#) [MIC4451YM](#) [MIC4452ZT](#) [MIC4452YM](#) [MIC4452YM TR](#) [MIC4451YN](#) [MIC4451ZT](#) [MIC4452YN](#)
[MIC4451YM-TR](#) [MIC4452YM-TR](#) [MIC4452VM-TR](#) [MIC4452VM](#)