

UP

UNI-PAC™ drum core power inductors



Product features

- Maximum power density
- Ideal for applications requiring low inductance and high current in a miniature package
- Current range from 0.47 A to 19.2 A
- Inductance range from 0.470 uH to 1000 uH
- Protective case eliminates core breakage
- Meets UL 94V-0 flammability standard
- Ferrite core material

Applications

- Buck or boost inductor
- Workstations/servers
- Desktop computer
- DVD Players
- Portable power devices
- Base stations
- Industrial power supplies
- Output filter chokes
- Test equipment instrumentation

Environmental Data

- Storage temperature range (Component): -40 °C to +125 °C
- Operating temperature range: -40 °C to +125 °C (ambient plus self-temperature rise)
- Solder reflow temperature: J-STD-020 (latest revision) compliant



Product Specifications

Part Number	Inductance μH (rated)	OCL ⁽¹⁾ $\mu\text{H} \pm 20\%$	I RMS ⁽²⁾ (A)	I SAT ⁽³⁾ (A)	DCR ⁽⁴⁾ Ohms max.
UP1B-R47-R	0.47	0.569	6.0	7.7	0.0097
UP1B-1R0-R	1.0	1.20	4.4	5.3	0.0177
UP1B-1R5-R	1.5	1.61	4.2	4.5	0.0200
UP1B-2R2-R	2.2	2.62	3.1	3.5	0.0363
UP1B-3R3-R	3.3	3.79	2.9	3.0	0.0428
UP1B-4R7-R	4.7	5.15	2.2	2.6	0.0544
UP1B-6R8-R	6.8	6.87	1.7	2.2	0.0897
UP1B-100-R	10.0	11.00	1.5	1.9	0.1107
UP1B-150-R	15.0	16.00	1.2	1.5	0.1747
UP1B-220-R	22.0	23.50	1.0	1.2	0.2541
UP1B-330-R	33.0	36.00	0.82	0.99	0.3670
UP1B-470-R	47.0	48.50	0.72	0.87	0.4740
UP1B-680-R	68.0	73.52	0.58	0.67	0.7320
UP1B-101-R	100.0	112.67	0.47	0.53	1.11
UP1B-151-R	150.0	152.40	0.40	0.46	1.61
UP1B-221-R	220.0	223.10	0.36	0.38	1.96
UP1B-331-R	330.0	331.90	0.28	0.31	3.10
UP2B-R47-R	0.47	0.595	10.6	11.4	0.0049
UP2B-1R0-R	1.0	1.00	9.3	9.9	0.0065
UP2B-1R5-R	1.5	1.46	8.3	7.9	0.0081
UP2B-2R2-R	2.2	2.56	7.2	6.1	0.0107
UP2B-3R3-R	3.3	3.23	6.5	5.1	0.0128
UP2B-4R7-R	4.7	4.77	5.5	4.2	0.0165
UP2B-6R8-R	6.8	6.63	5.0	3.6	0.0202
UP2B-100-R	10.0	9.73	4.3	3.3	0.0267
UP2B-150-R	15.0	15.43	3.5	2.4	0.0410
UP2B-220-R	22.0	22.50	2.8	2.0	0.0617
UP2B-330-R	33.0	33.13	2.1	1.7	0.0917
UP2B-470-R	47.0	48.65	1.7	1.4	0.1388
UP2B-680-R	68.0	68.17	1.5	1.2	0.1787
UP2B-820-R	82.0	84.1	1.34	1.03	0.2235
UP2B-101-R	100.0	102.60	1.2	0.95	0.2707
UP2B-151-R	150.0	150	1.0	0.77	0.4100
UP2B-221-R	220.0	223	0.773	0.637	0.6717
UP2B-331-R	330.0	338	0.676	0.510	0.8783
UP2B-471-R	470.0	471	0.553	0.427	1.31
UP2B-681-R	680.0	700	0.452	0.355	1.97
UP2B-821-R	820.0	823	0.423	0.334	2.24
UP2B-102-R	1000.0	1005	0.369	0.300	2.96
UP3B-R47-R	0.47	0.452	16.0	25.1	0.0021
UP3B-1R0-R	1.0	1.34	12.5	15.3	0.0034
UP3B-1R5-R	1.5	2.08	10.0	12.0	0.0053
UP3B-2R2-R	2.2	3.01	9.2	10.2	0.0074
UP3B-3R3-R	3.3	3.96	8.0	9.3	0.0083
UP3B-4R7-R	4.7	5.00	6.5	7.7	0.0114
UP3B-6R8-R	6.8	7.70	5.8	6.2	0.0183
UP3B-100-R	10.0	11.00	4.3	5.2	0.0260
UP3B-150-R	15.0	16.38	3.9	4.3	0.0317
UP3B-220-R	22.0	23.93	3.1	3.7	0.0490
UP3B-330-R	33.0	33.85	2.4	3.0	0.0688
UP3B-470-R	47.0	51.00	1.9	2.4	0.1082
UP3B-680-R	68.0	69.50	1.6	2.0	0.1558
UP3B-101-R	100.0	101.40	1.4	1.8	0.2053
UP3B-151-R	150.0	152.9	1.2	1.4	0.2960
UP3B-331-R	330.0	332.80	0.75	0.98	0.7330
UP4B-R47-R	0.47	0.473	19.2	51.7	0.0019
UP4B-1R0-R	1.0	0.916	17.3	37.3	0.0023
UP4B-1R5-R	1.5	1.52	13.4	28.9	0.0039
UP4B-2R2-R	2.2	2.27	12.0	23.7	0.0048
UP4B-3R3-R	3.3	3.14	11.0	20.2	0.0057
UP4B-4R7-R	4.7	5.34	8.6	15.6	0.0093
UP4B-6R8-R	6.8	6.66	8.3	14.1	0.0100
UP4B-100-R	10.0	9.77	6.8	11.5	0.0150
UP4B-150-R	15.0	15.61	5.5	9.1	0.0230
UP4B-220-R	22.0	22.61	4.5	7.6	0.0340
UP4B-330-R	33.0	34.30	3.7	6.1	0.0520
UP4B-470-R	47.0	48.10	3.1	5.2	0.0740
UP4B-680-R	68.0	69.14	2.4	4.3	0.1200
UP4B-101-R	100.0	99.42	2.0	3.6	0.1700
UP4B-151-R	150.0	146.90	1.7	3.0	0.2392
UP4B-221-R	220.0	221.40	1.4	2.4	0.3571
UP4B-331-R	330.0	330.00	1.1	2.0	0.5800
UP4B-471-R	470.0	470.10	0.91	1.7	0.8330

Notes: (1) Open Circuit Inductance Test Parameters: 100 kHz, 250 Vrms, 0.0 A dc.
(2) RMS current for an approximate ΔT of 40 °C. at an ambient temperature of +85 °C.

(3) Peak current for approximately 30% rolloff UP1B, 3B, 4B. 10% rolloff UP2B @ +20 °C
(4) DCR limits +20 °C.

Dimensions- mm

UP1B

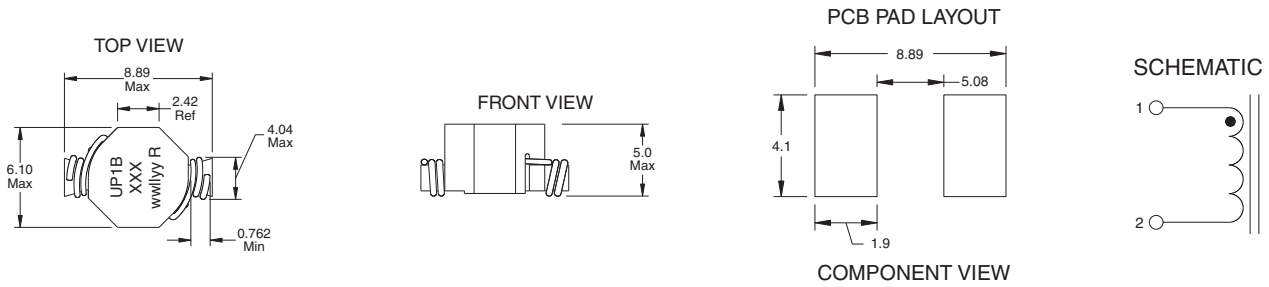

UP2B

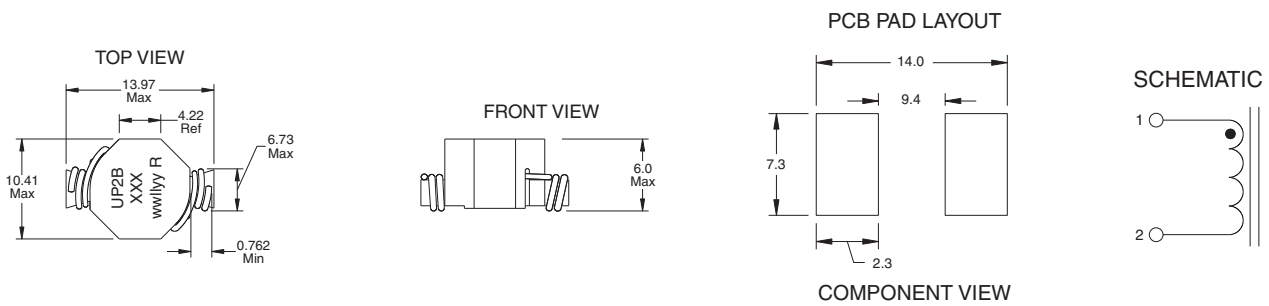

UP3B

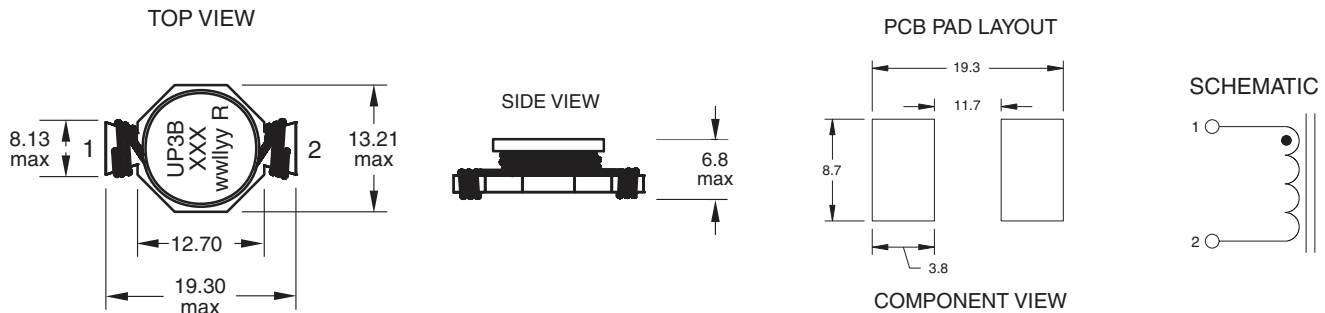

UP4B

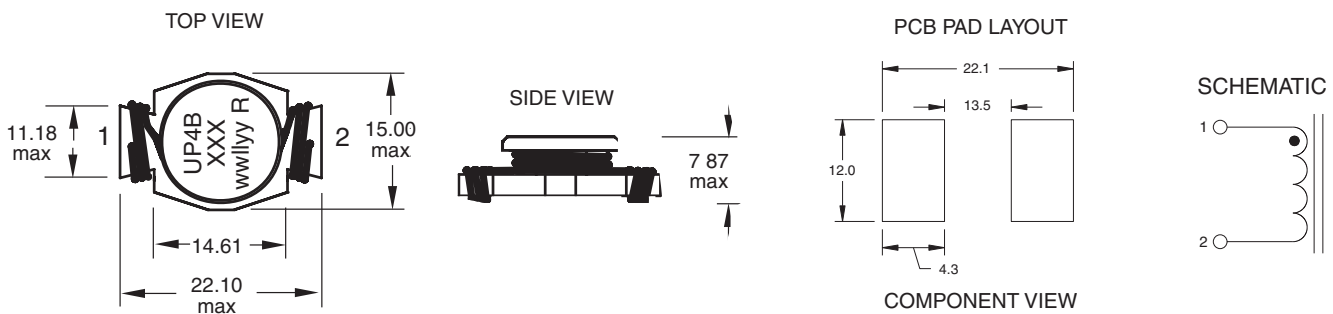

Do not route traces or vias underneath inductor

wwllyy = (date code) R = revision level
xxx = Inductance value per family chart

Packaging information- mm

UP1B

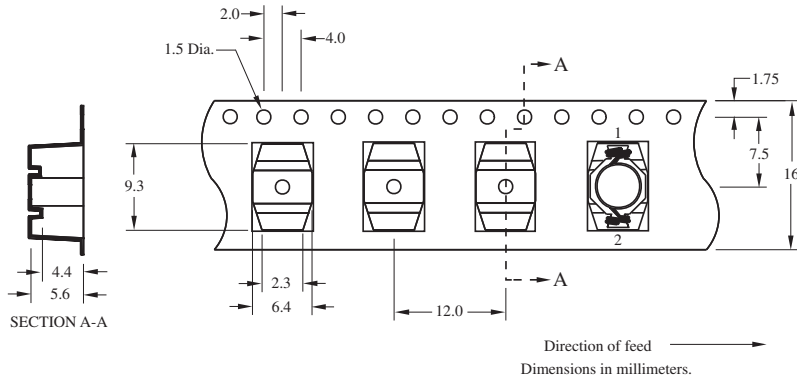

Parts packaged on 13" Diameter reel,
900 parts per reel.

UP2B

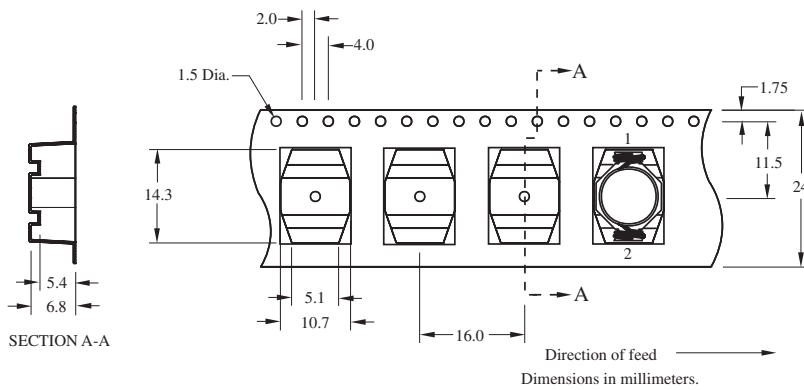

Parts packaged on 13" Diameter reel,
550 parts per reel.

UP3B

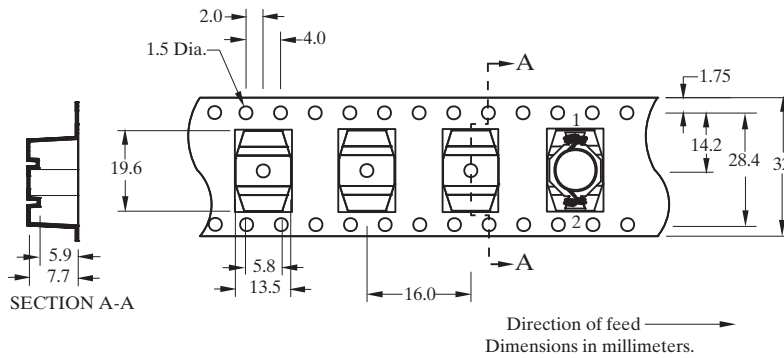

Parts packaged on 13" Diameter reel,
450 parts per reel.

UP4B

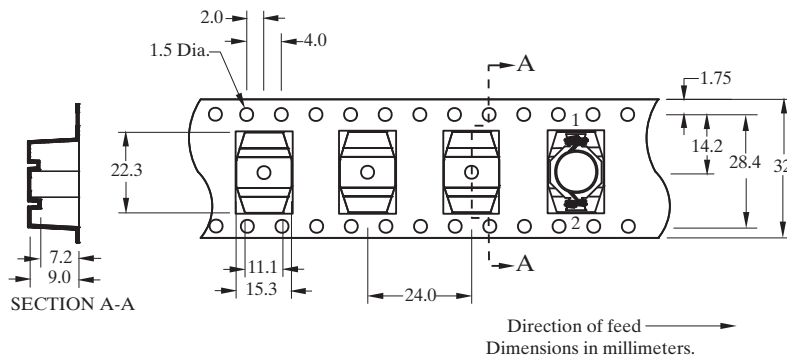

Parts packaged on 13" Diameter reel,
275 parts per reel.

Inductance characteristics

UP1B-1R0

Typical Inductance & Energy vs Saturation Current

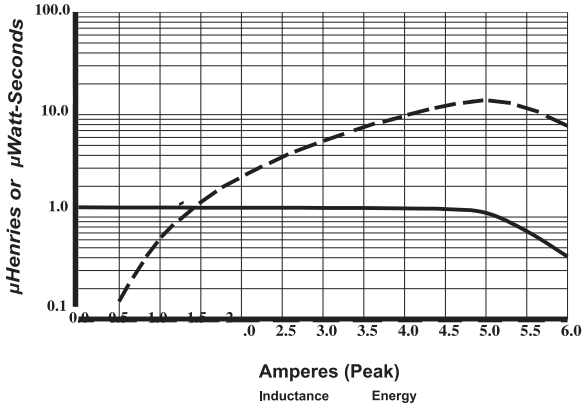

UP1B-100

Typical Inductance & Energy vs Saturation Current

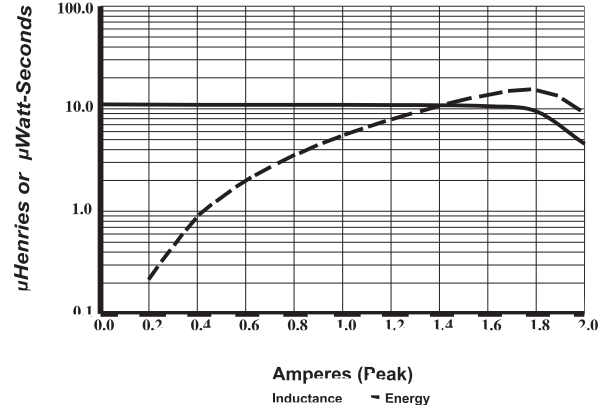

UP1B-470

Typical Inductance & Energy vs Saturation Current

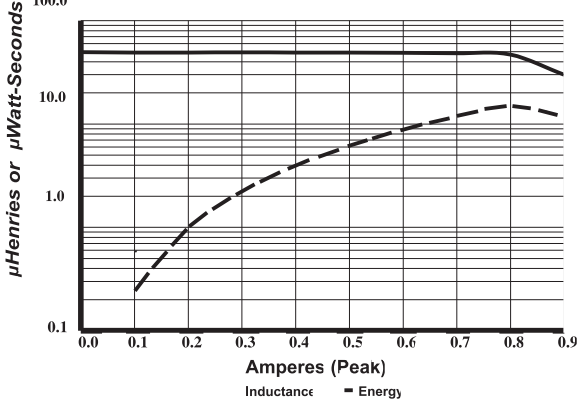

UP2B-1R0

Typical Inductance & Energy vs Saturation Current

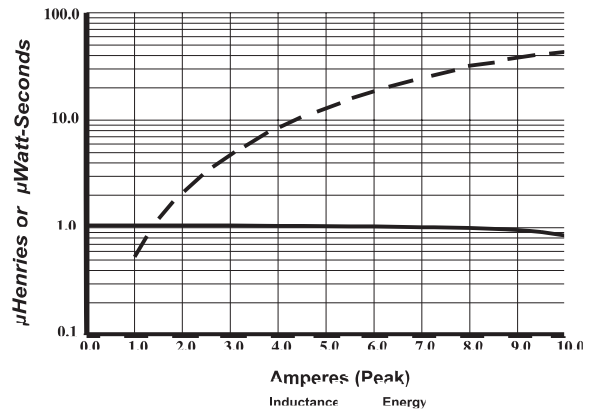

UP2B-100

Typical Inductance & Energy vs Saturation Current

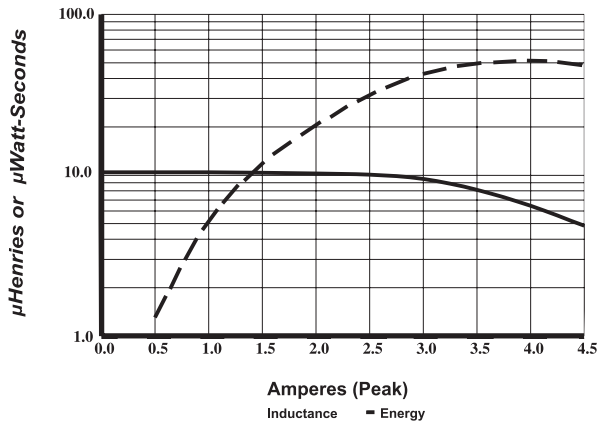

UP2B-470

Typical Inductance & Energy vs Saturation Current

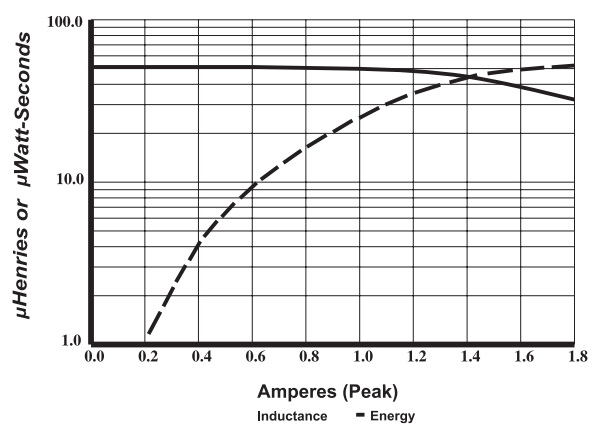

Inductance characteristics

UP3B-1R0

Typical Inductance & Energy vs Saturation Current

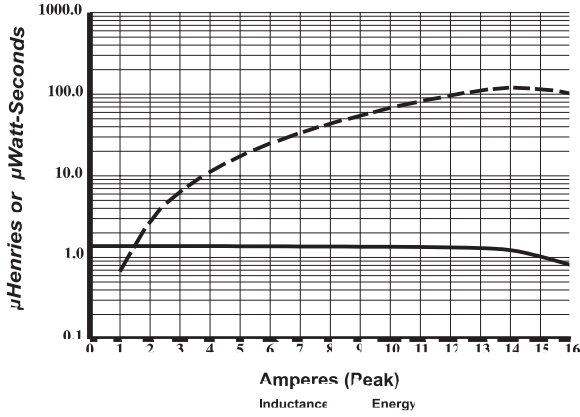

UP3B-100

Typical Inductance & Energy vs Saturation Current

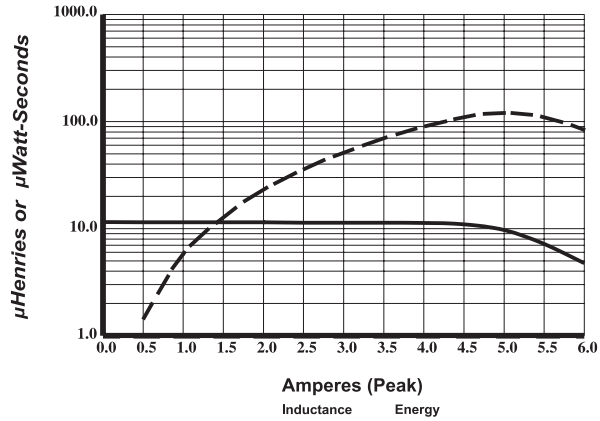

UP3B-470

Typical Inductance & Energy vs Saturation Current

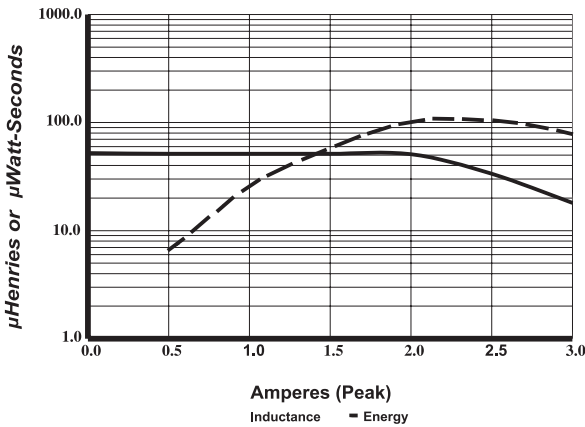

UP4B-1R0

Typical Inductance & Energy vs Saturation Current

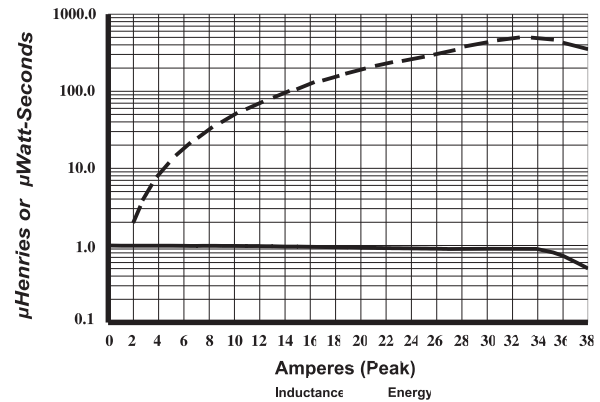

UP4B-100

Typical Inductance & Energy vs Saturation Current

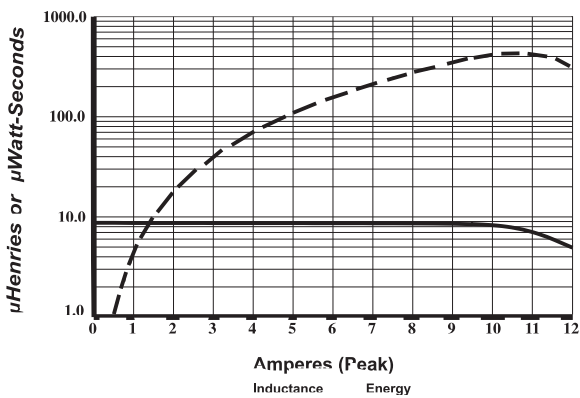

UP4B-470

Typical Inductance & Energy vs Saturation Current

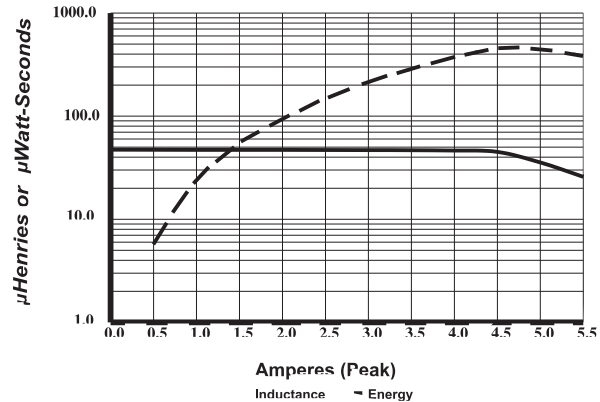

Solder Reflow Profile

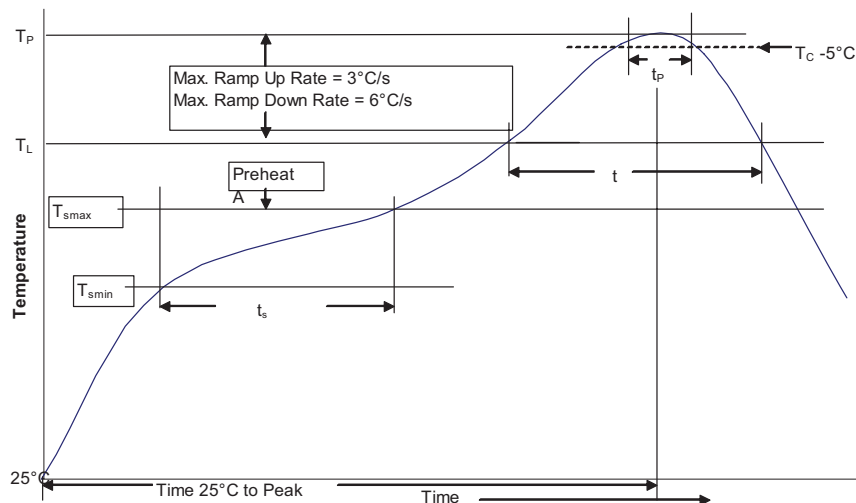

Table 1 - Standard SnPb Solder (T_c)

Package Thickness	Volume <350 mm ³	Volume ≥ 350 mm ³
<2.5 mm	235°C	220°C
≥ 2.5 mm	220°C	220°C

Table 2 - Lead (Pb) Free Solder (T_c)

Package Thickness	Volume <350 mm ³	Volume $350 - 2000$ mm ³	Volume >2000 mm ³
<1.6 mm	260°C	260°C	260°C
1.6 – 2.5mm	260°C	250°C	245°C
>2.5 mm	250°C	245°C	245°C

Reference JDEC J-STD-020

Profile Feature	Standard SnPb Solder	Lead (Pb) Free Solder
Preheat and Soak		
• Temperature min. (T_{smin})	100°C	150°C
• Temperature max. (T_{smax})	150°C	200°C
• Time (T_{smin} to T_{smax}) (t_s)	60-120 Seconds	60-120 Seconds
Average ramp up rate T_{smax} to T_p	3°C/ Second Max.	3°C/ Second Max.
Liquidous temperature (T_L)	183°C	217°C
Time at liquidous (t_L)	60-150 Seconds	60-150 Seconds
Peak package body temperature (T_p)*	Table 1	Table 2
Time (t_p)** within 5 °C of the specified classification temperature (T_c)	20 Seconds**	30 Seconds**
Average ramp-down rate (T_p to T_{smax})	6°C/ Second Max.	6°C/ Second Max.
Time 25°C to Peak Temperature	6 Minutes Max.	8 Minutes Max.

* Tolerance for peak profile temperature (T_p) is defined as a supplier minimum and a user maximum.

** Tolerance for time at peak profile temperature (t_p) is defined as a supplier minimum and a user maximum.

Life Support Policy: Eaton does not authorize the use of any of its products for use in life support devices or systems without the express written approval of an officer of the Company. Life support systems are devices which support or sustain life, and whose failure to perform, when properly used in accordance with instructions for use provided in the labeling, can be reasonably expected to result in significant injury to the user.

Eaton reserves the right, without notice, to change design or construction of any products and to discontinue or limit distribution of any products. Eaton also reserves the right to change or update, without notice, any technical information contained in this bulletin.

Eaton
Electronics Division
1000 Eaton Boulevard
Cleveland, OH 44122
United States
www.eaton.com/electronics

© 2017 Eaton
All Rights Reserved
Printed in USA
Publication No. DS4308
August 2017

Mouser Electronics

Authorized Distributor

Click to View Pricing, Inventory, Delivery & Lifecycle Information:

[Eaton:](#)

[UP1B-R47-R](#) [UP1B-1R0-R](#) [UP1B-1R5-R](#) [UP1B-100-R](#) [UP1B-101-R](#) [UP1B-150-R](#) [UP1B-151-R](#) [UP1B-2R2-R](#)
[UP1B-220-R](#) [UP1B-221-R](#) [UP1B-3R3-R](#) [UP1B-330-R](#) [UP1B-331-R](#) [UP1B-4R7-R](#) [UP1B-470-R](#) [UP1B-6R8-R](#)
[UP1B-680-R](#) [UP2B-R47-R](#) [UP2B-1R0-R](#) [UP2B-1R5-R](#) [UP2B-100-R](#) [UP2B-101-R](#) [UP2B-102-R](#) [UP2B-150-R](#)
[UP2B-151-R](#) [UP2B-2R2-R](#) [UP2B-220-R](#) [UP2B-221-R](#) [UP2B-3R3-R](#) [UP2B-330-R](#) [UP2B-331-R](#) [UP2B-4R7-R](#)
[UP2B-470-R](#) [UP2B-471-R](#) [UP2B-6R8-R](#) [UP2B-680-R](#) [UP2B-681-R](#) [UP2B-820-R](#) [UP2B-821-R](#) [UP3B-R47-R](#) [UP3B-](#)
[1R0-R](#) [UP3B-1R5-R](#) [UP3B-100-R](#) [UP3B-101-R](#) [UP3B-150-R](#) [UP3B-151-R](#) [UP3B-2R2-R](#) [UP3B-220-R](#) [UP3B-3R3-](#)
[R](#) [UP3B-330-R](#) [UP3B-331-R](#) [UP3B-4R7-R](#) [UP3B-470-R](#) [UP3B-6R8-R](#) [UP3B-680-R](#) [UP4B-R47-R](#) [UP4B-1R0-R](#)
[UP4B-1R5-R](#) [UP4B-100-R](#) [UP4B-101-R](#) [UP4B-150-R](#) [UP4B-151-R](#) [UP4B-2R2-R](#) [UP4B-220-R](#) [UP4B-221-R](#) [UP4B-](#)
[3R3-R](#) [UP4B-330-R](#) [UP4B-331-R](#) [UP4B-4R7-R](#) [UP4B-470-R](#) [UP4B-471-R](#) [UP4B-6R8-R](#) [UP4B-680-R](#) [UP2-3R3-R](#)