



TVS/ESD Arrays

RLSD32Axx1LV Series

TVS/ESD Arrays - RLSD32Axx1LV Series

Features

- 350 Watts Peak Pulse Power per Line ($t_p = 8/20\mu s$)
- Working voltages: 3.3V、 5V、 8V、 12V、 15V、 18V、 24V、 36V
- Low Leakage Current
- Low operating and clamping voltages
- Lead Free/RoHS compliant
- Solid-state silicon avalanche technology
- Provides ESD protection to IEC61000-4-2(ESD):
 - ±15kV (air discharge)
 - ±8kV (contact discharge)



Mechanical Characteristics

- SOD-323 package
- Molding compound flammability rating: UL 94V-0
- Packaging: Tape and Reel per EIA 481
- Quantity Per Reel : 3,000pcs
- Lead Finish: Matte tin
- RoHS Compliant

Applications

- Cell Phone Handsets and Accessories
- Microprocessor based equipment
- Personal Digital Assistants (PDA's)
- Notebooks, Desktops, and Servers
- Portable Instrumentation
- Pagers Peripherals

Pinout and Functional Block Diagram

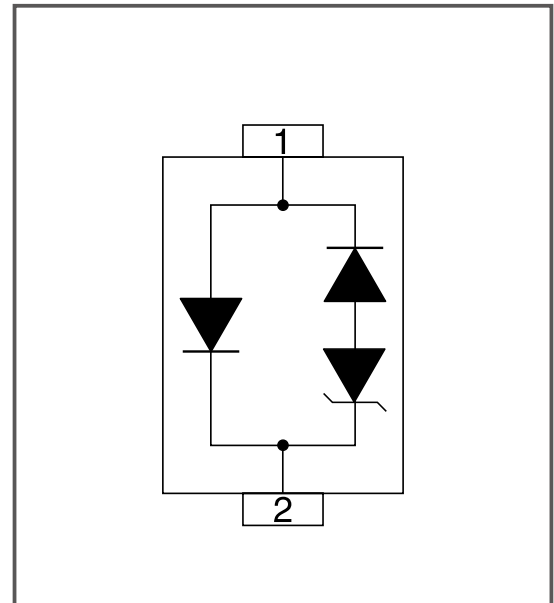

TVS/ESD Arrays - RLSD32Axx1LV Series

Absolute Maximum Rating

Rating	Symbol	Value	Units
Peak Pulse Power (tp =8/20μs)	PPK	350	Watts
ESD Voltage (Contact)	V _{ESD}	±8	Kv
ESD Voltage (Air)	V _{ESD}	±15	Kv
Lead Soldering Temperature	T _L	260 (10 sec.)	°C
Operating Temperature	T _J	-55 to +125	°C
Storage Temperature	T _{STG}	-55 to +150	°C

Electrical Parameters (T=25°C)

Symbol	Parameter
I _{PP}	Maximum Reverse Peak Pulse Current
V _C	Clamping Voltage @ I _{PP}
V _{RWM}	Working Peak Reverse Voltage
I _R	Maximum Reverse Leakage Current @ V _{RWM}
V _{BR}	Breakdown Voltage @ I _T
I _T	Test Current
I _F	Forward Current
V _F	Forward Voltage @ I _F

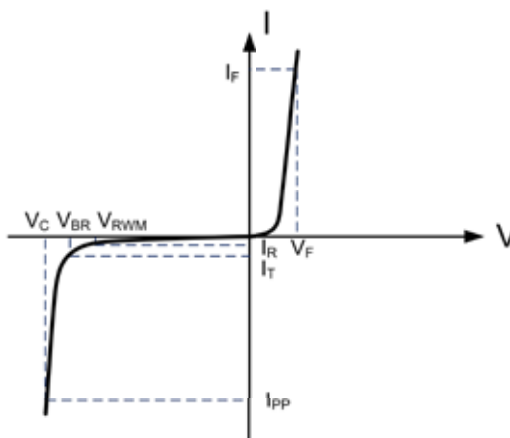

Electrical Characteristics Per Lin (@ 25°C Unless Otherwise Specified)

Type Number	Reverse Stand-Off Voltage	Minimum Breakdown Voltage	Peak Pulse Voltage @8/20μS	Peak Pulse Current @8/20μS	Reverse Leakage @V _{RWM}	Typical Capacitance
	V _{RWM}	V _{BR} @1mA	V _C @1A	I _{PP}	I _R @V _{RWM}	DC=0V C _J @ 1 MHz
	V	V	V	A	μA	pF
RLSD32A031LV	3.3	4	7.5	15	40	1.5
RLSD32A051LV	5	6	9.8	14	5	1.5
RLSD32A081LV	8	8.5	13.4	12	1	1.5
RLSD32A121LV	12	13.3	19	7	1	1.5
RLSD32A151LV	15	16.7	24	5	1	1.5
RLSD32A181LV	18	19	29	4	1	1.5
RLSD32A241LV	24	26.7	43	2	1	1.5
RLSD32A361LV	36	40	60	1	1	1.5

TVS/ESD Arrays - RLSD32Axx1LV Series

Characteristic Curves

Fig1. 8/20μs Pulse Waveform

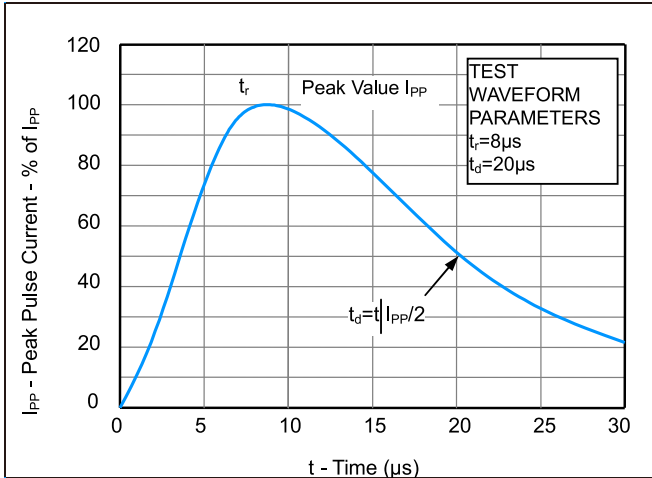

Fig2. ESD Pulse Waveform (according to IEC 61000-4-2)

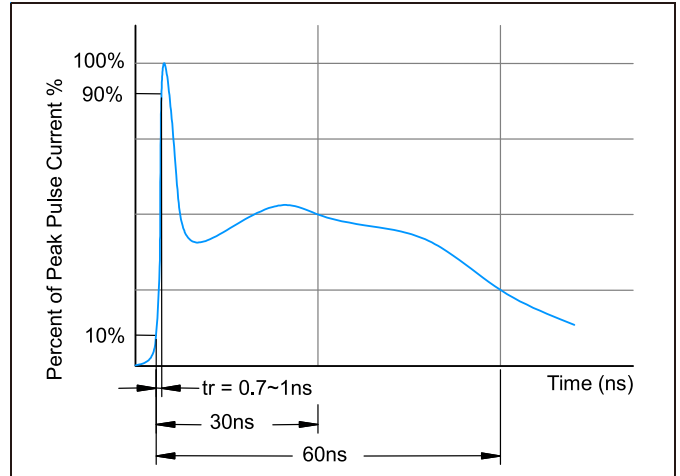

Fig3. Power Derating Curve

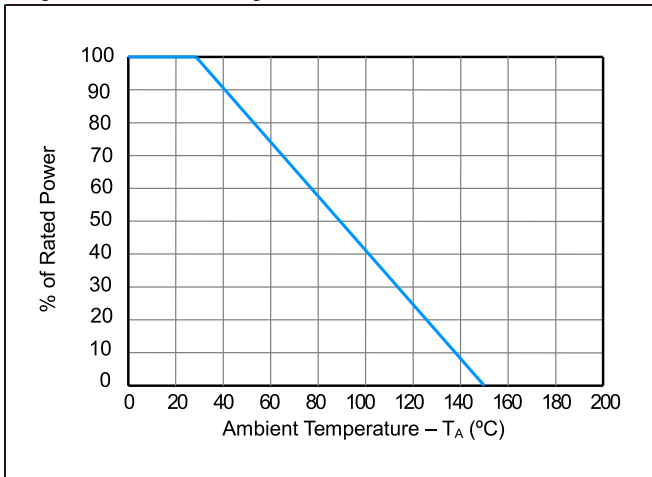
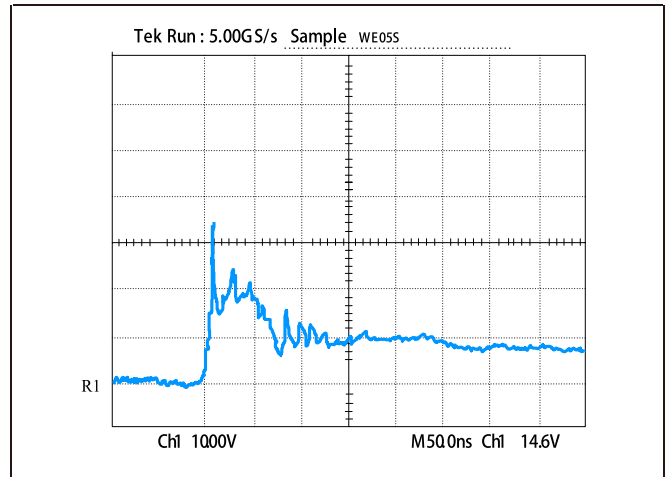
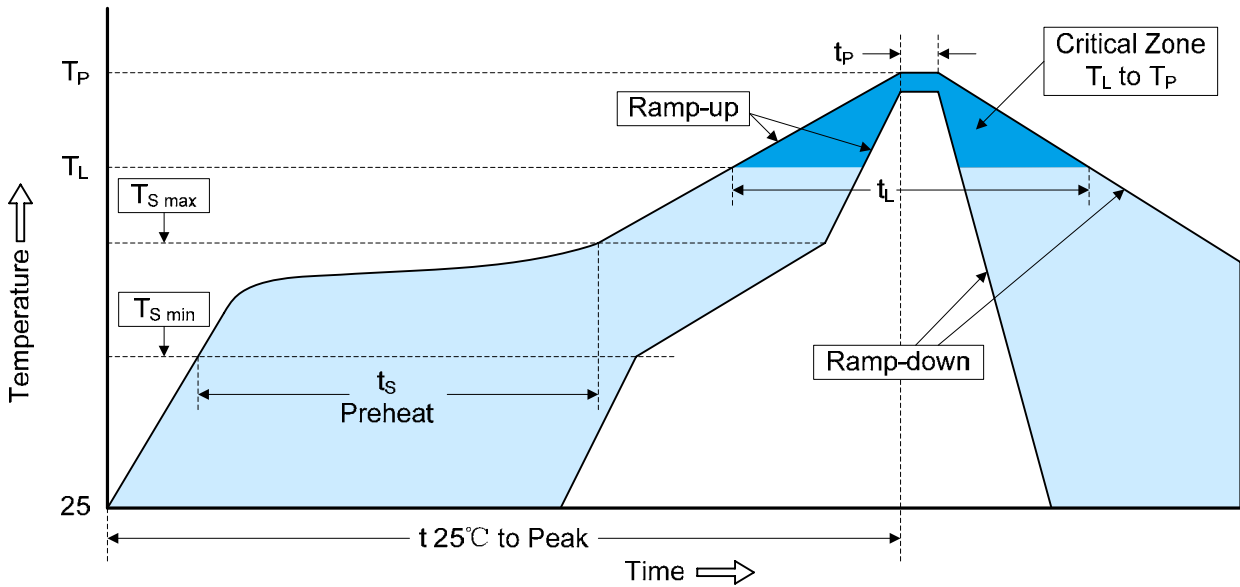

Figure 4: ESD Clamping (8kV Contact per IEC 61000-4-2)



TVS/ESD Arrays - RLSD32Axx1LV Series

Recommended Soldering Conditions



Profile Feature	Pb-Free Assembly
Average ramp-up rate (T_L to T_P)	3°C/second max.
Preheat	150°C
-Temperature Min ($T_{S\ min}$)	200°C
-Temperature Max ($T_{S\ max}$)	60-180 seconds
-Time (min to max) (t_s)	
$T_{S\ max}$ to T_L	3°C/second max.
-Ramp-up Rate	
Time maintained above:	217°C
-Temperature (T_L)	60-150 seconds
-Time (t_L)	
Peak Temperature (T_P)	260°C
Time within 5°C of actual Peak Temperature (t_p)	20-40 seconds
Ramp-down Rate	6°C/second max.
Time 25°C to Peak Temperature	8 minutes max.

TVS/ESD Arrays - RLSD32Axx1LV Series

Package dimension SOD-323

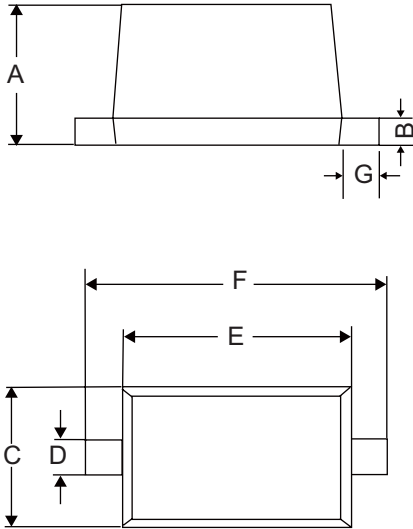

Dimensions				
Symbol	Inches		Millimeters	
	Min	Max	Min	Max
A	0.031	0.040	0.8	1.0
B	0.004	0.010	0.10	0.25
C	0.045	0.054	1.2	1.4
D	0.012	0.016	0.3	0.4
E	0.060	0.071	1.5	1.8
F	0.090	0.107	2.3	2.7
G	0.006	0.010	0.15	0.25

Part Number Code

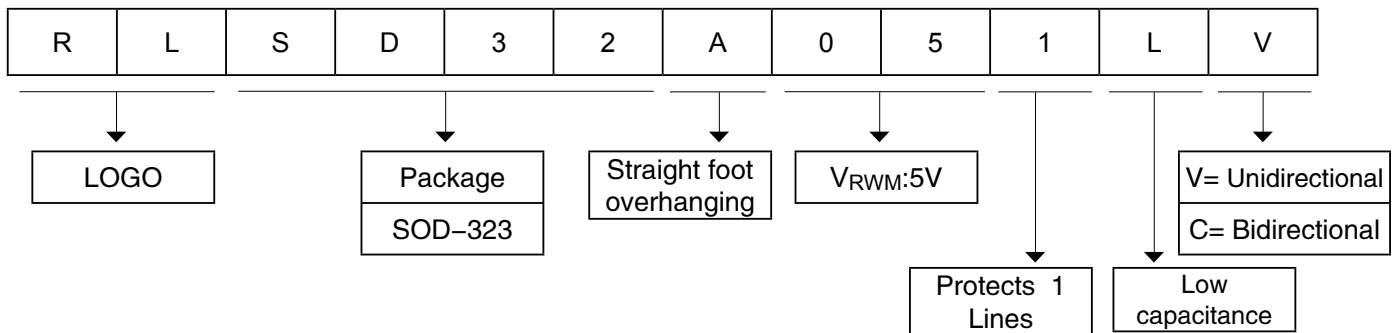

Ordering Information

Part Number	Package	Min. Order Qty.
RLSD32Axx1LV	SOD-323	3000pcs

RuiLongYuan Electronics Co., Ltd.

- Reproducing and modifying information of the document is prohibited without permission from Ruilongyuan International Inc.
- Ruilongyuan International Inc. reserves the rights to make changes of the content herein the document anytime without notification. Please refer to our website for the latest document.
- Ruilongyuan International Inc. disclaims any and all liability arising out of the application or use of any product including damages incidentally and consequentially occurred.
- Ruilongyuan International Inc. does not assume any and all implied warranties, including warranties of fitness for particular purpose, non-infringement and merchantability.
- Applications shown on the herein document are examples of standard use and operation. Customers are responsible in comprehending the suitable use in particular applications. Ruilongyuan International Inc. makes no representation or warranty that such applications will be suitable for the specified use without further testing or modification.
- The products shown herein are not designed and authorized for equipments requiring high level of reliability or relating to human life and for any applications concerning life-saving or life-sustaining, such as medical instruments, transportation equipment, aerospace machinery et cetera. Customers using or selling these products for use in such applications do so at their own risk and agree to fully indemnify Ruilongyuan International Inc. for any damages resulting from such improper use or sale.

Tel: +86-755-8290 8296

Fax: +86-755-8290 8002

E-mail: jack@ruilon.com