



# IR Emitter and Detector Product Data Sheet

## HSDL-4251

Spec No.: DS50-2008-0024

Effective Date: 04/30/2013

Revision: A

**LITE-ON DCC**

**RELEASE**

BNS-OD-FC001/A4

## FEATURES

- \* High power AlGaAs LED technology
- \* T-1 3/4 Package
- \* 870 nm Wavelength
- \* High speed: 40ns Rise times
- \* Low Forward Voltage
- \* Low forward voltage for series operation

- \* Applications
- High Speed IR communications
- Portable Infrared Instruments
- Consumer Electronics
- (Optical mouse, Infrared Remote Controllers ect)
- High Speed Infrared Communications
- (IR LANs , IR Moldens , IR Dongles , etc)



## PACKAGE DIMENSIONS

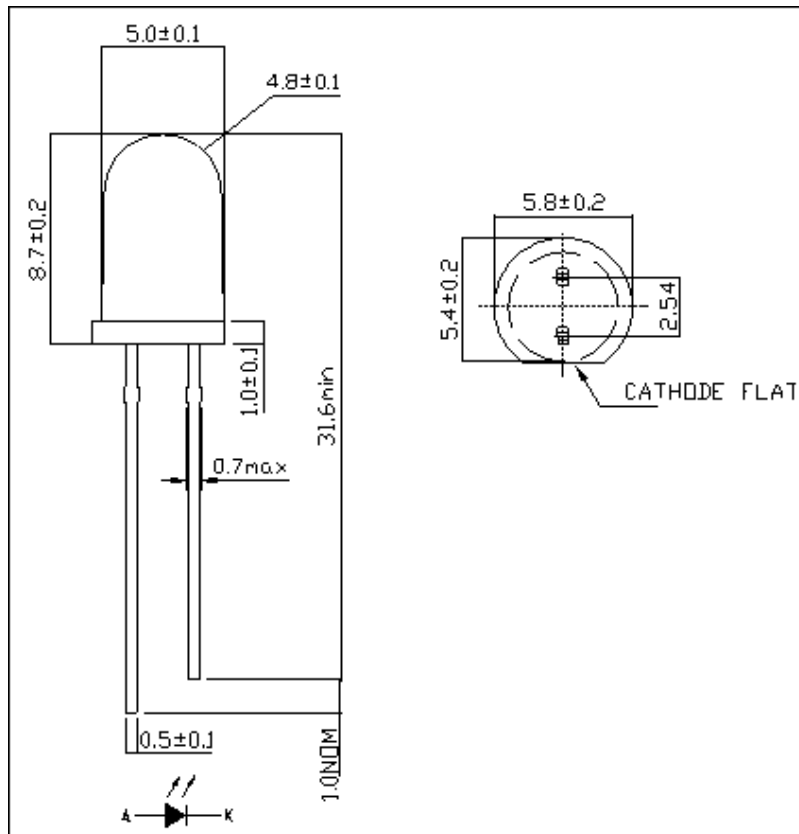

### NOTES:

1. All dimensions are in millimeters (inches).
2. Tolerance is  $\pm 0.25\text{mm}$  (.010") unless otherwise noted.
3. Protruded resin under flange is 1.5mm (.059") max.
4. Lead spacing is measured where the leads emerge from the package.
5. Specifications are subject to change without notice.



# LITE-ON TECHNOLOGY CORPORATION.

Property of Lite-On Only

## ABSOLUTE MAXIMUM RATINGS AT TA=25°C

PARAMETER	Symbol	MIN	MAX	UNIT	Reference
Forward Current	I <sub>FDC</sub>		100	mA	[1]
Peak Forward Current	I <sub>FPK</sub>		500	mA	Fig 3 Duty Factor=20% Pulse Width=100us
Power Dissipation	P <sub>DISS</sub>		190	mW	
Reverse Voltage	V <sub>R</sub>	5		V	I <sub>R</sub> =100uA
Storage Temperature	T <sub>S</sub>	-40	100	°C	
LED Junction Temperature	T <sub>J</sub>		110	°C	
Lead Soldering Temperature [1.6mm(.063") From Body]			260 for 5 seconds	°C	

Notes:

1. Derate as shown in Figure 6.

## Recommended Operating Conditions

PARAMETER	Symbol	MIN	MAX	UNIT	Reference
Operating Temperature	T <sub>O</sub>	-40	85	°C	



# LITE-ON TECHNOLOGY CORPORATION.

Property of Lite-On Only

## ELECTRICAL CHARACTERISTICS AT 25°C

PARAMETER	Symbol	MIN.	TYP.	MAX.	UNIT	TEST CONDITION	Reference
Forward Voltage	$V_F$		1.4	1.6	V	$I_{FDC} = 20\text{mA}$	Fig.2
			1.5	1.9	V	$I_{FDC} = 100\text{mA}$	Fig.3
Forward Voltage Temperature Coefficient	$\Delta V / \Delta T$		-1.44		mV/°C	$I_{FDC} = 100\text{mA}$	Fig.4
Series Resistance	$R_S$		2.5		0hms	$I_{FDC} = 100\text{mA}$	
Diode Capacitance	$C_O$		75		pF	0 V, 1 MHz	
Reverse Voltage	$V_R$	2	20		V	$I_R = 100 \mu A$	
Thermal Resistance, Junction to Pin	$R \theta_{JA}$		300		°C/W		

### OPTICAL CHARACTERISTICS AT TA=25°C

PARAMETER	Symbol	MIN.	TYP.	MAX.	UNIT	Test condition	Reference
Radiant On-Axis Intensity	$I_E$	56	100		Mw/Sr	$I_{FDC} = 100\text{mA}$	Fig.5
Radiant On-Axis Intensity Temperature Coefficient	$\Delta I_E / \Delta T$	-	-0.43	-	%/°C	$I_{FDC} = 100\text{mA}$	
Viewing Angle	$2\theta_{1/2}$	-	30	-	deg	$I_{FDC} = 50\text{mA}$	Fig.7
Peak Wavelength	$\lambda_{pk}$	-	870	-	nm	$I_{FDC} = 50\text{mA}$	Fig.1
Peak Wavelength Temperature Coefficient	$\Delta \lambda / \Delta T$	-	0.22	-	nm/°C	$I_{FDC} = 100\text{mA}$	
Spectral Width-at FWHM	$\Delta \lambda$		45	-	nm	$I_{FDC} = 50\text{mA}$	Fig.1
Optical Rise and all Times, 10%-90%	$T_r / T_f$		40	-	ns	$I_{FDC} = 500\text{ mA}$ Duty Ratio=20% Pulse Width=125ns	

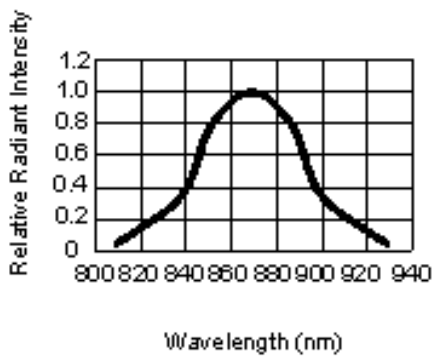

FIG.1 Relative Radiant Intensity VS Wavelength

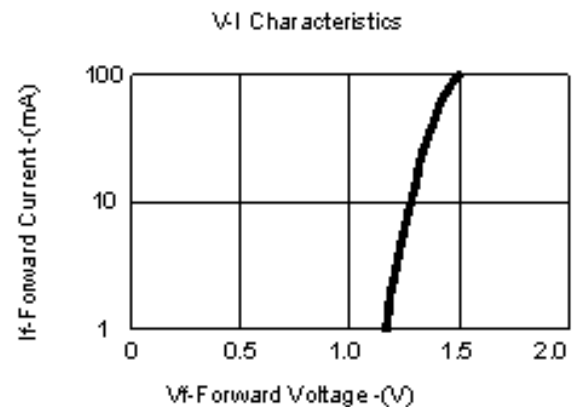

FIG.2 DC Forward Current VS. Forward Voltage

Peak Forward Voltage Vs Peak Forward Current

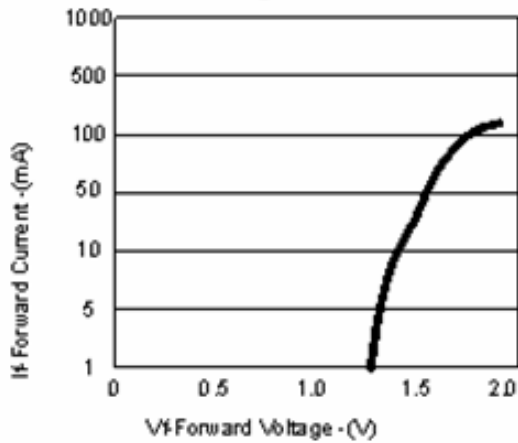

FIG.3 Peak Forward Current VS. Forward Voltage

Forward Current Vs Relative Radiant Intensity

Forward Voltage Vs Temperature

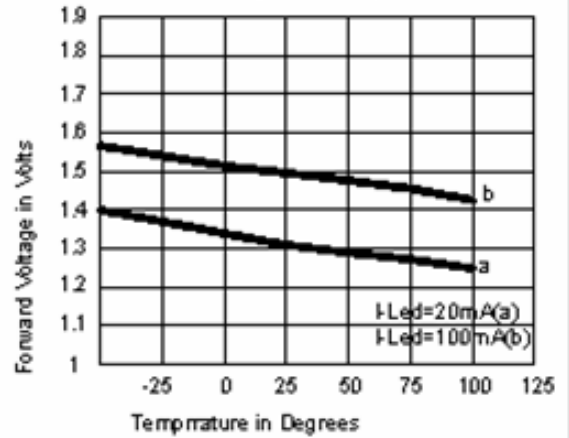

FIG.4 Forward Voltage VS. Ambient Temperature

Forward Current Vs Relative Radiant Intensity

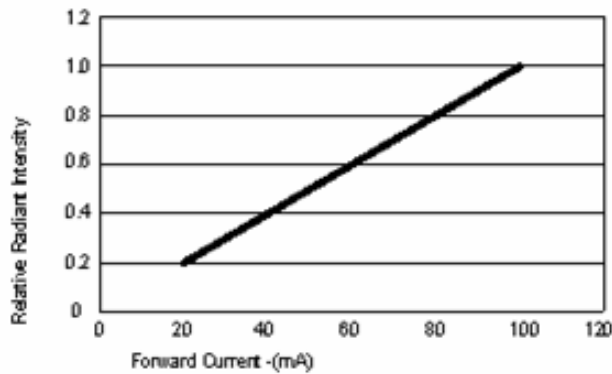

FIG.5 Relative Radiant Intensity vs DC Forward Current

Maximum Permissible DC forward current vs ambient temperature

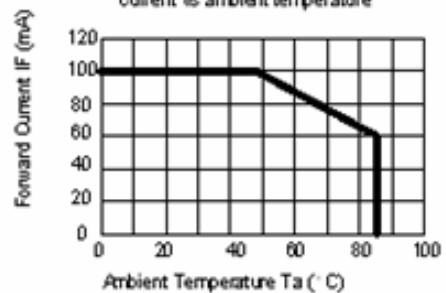
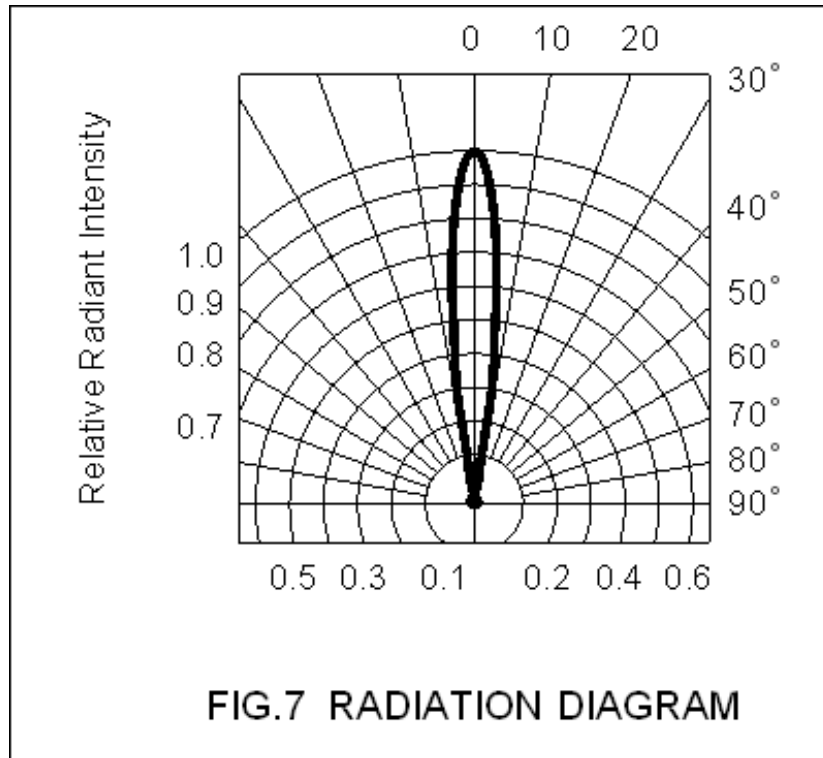

FIG.6 DC FORWARD CURRENT VS. AMBIENT TEMPERATURE DERATED (Based on TJMAX=110°C)



# Mouser Electronics

Authorized Distributor

Click to View Pricing, Inventory, Delivery & Lifecycle Information:

[Lite-On:](#)

[HSDL-4251](#)