

# Powerpole® Connectors

PP120 - Up to 240 Amps

POWERPOLE® PP120



PP120 series Powerpole® housings are designed to accommodate up to 1/0 AWG (50 mm<sup>2</sup>) wires and handle high currents up to 240 amps. Reducing bushings allow PP120 to accept down to 8 AWG (10 mm<sup>2</sup>) wires. Multiple colors of stackable housings combine with low resistance flat wiping technology to offer powerful connection capability.

- Large Wire Range Accommodates up to 1/0 (50 mm<sup>2</sup>) Wire**  
*Reducing bushings allow as small as 8 (10 mm<sup>2</sup>) wire to be used*
- Low Resistance Silver Plated Copper Contacts**  
*Allows currents up to 240 amps*
- UL Rated for Hot Plugging up to 60 Amps**  
*Great for battery or other applications where the ability to interrupt circuits is required*

## PP120 ORDERING INFORMATION

### PP120 Housings

The second to largest Powerpole® housing can be used with wire contacts for up to 1/0 AWG (50 mm<sup>2</sup>) or busbar contacts.

Description	Part Numbers	
Minimum Quantity	500	50
Blue	1321-BK	1321
Black	1321G1-BK	1321G1
White	1321G2-BK	1321G2
Red	1321G3-BK	1321G3
Green	1321G4-BK	1321G4
Orange	1321G5-BK	1321G5
Brown	1321G6-BK	1321G6
Yellow	1321G7-BK	1321G7
Gray	1321G8-BK	1321G8

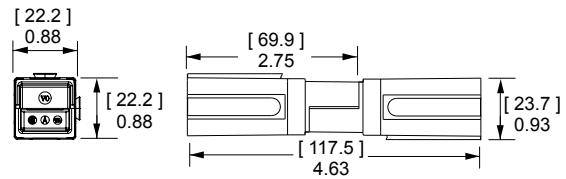

### PP120 Silver Plated Wire Contacts

Silver plated contacts offer superior electrical performance and durability up to 10,000 mating cycles. New contacts for 1 to 1/0 AWG (35 to 50 mm<sup>2</sup>) offer extended capability in the same housings. See reducing bushings in accessory section for smaller wires.

AWG	mm <sup>2</sup>	Mating Force	Loose Piece Part Numbers			- A -		- B -	
			600	500	50	inches	mm	inches	mm
1/0	53.5	Low	1323G2-BK	-	1323G2 *	0.52	13.21	0.44	11.18
1	42.4	Low	1323G1-BK	-	1323G1 *	0.47	11.94	0.39	9.91
2	33.6	High	-	1319-BK	1319	0.44	11.18	0.34	8.64
4	21.1	High	-	1319G4-BK	1319G4	0.44	11.18	0.29	7.37
6	13.3	High	-	1319G6-BK	1319G6	0.44	11.18	0.22	5.59

\* Extended range

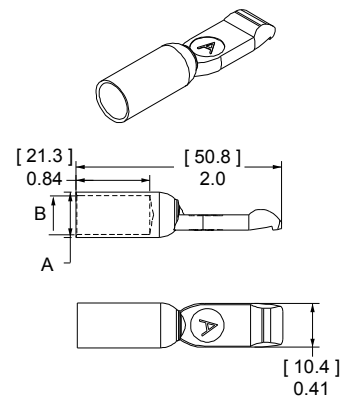

# PP120 CONNECTOR TEMPERATURE CHARTS - Temperature rise charts are based on a 25°C ambient temperature.

Current - Temperature Derating per IEC 60512-5-2 Test 5B

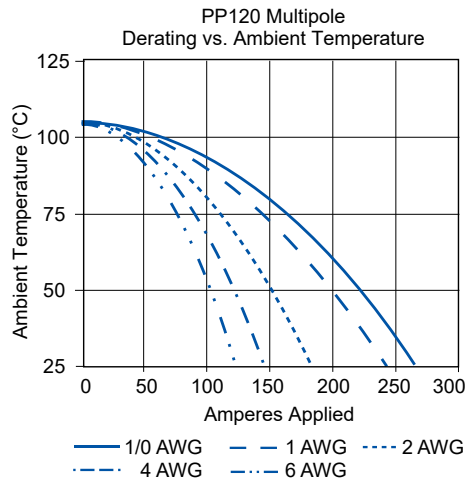
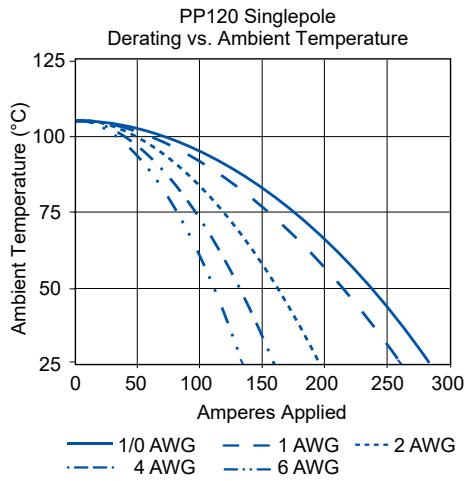
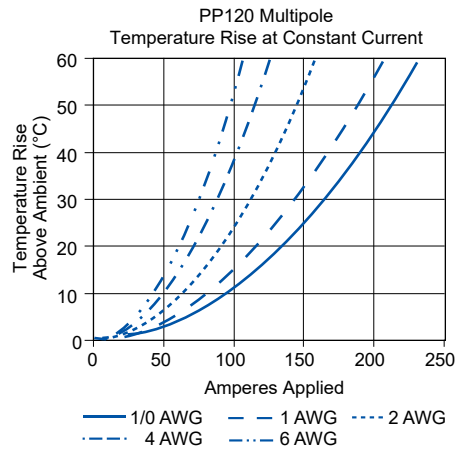
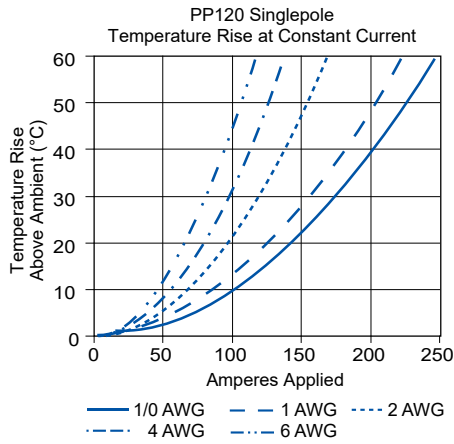

POWERPOLE® PP120

# PP120 SPECIFICATIONS

## ELECTRICAL

<b>Current Rating Amperes <sup>1</sup></b>	<b>UL 1977</b>	<b>CSA</b>
Singlepole UL 1977 (1/0 AWG)	240	155
2x2 Block UL 1977 (1/0 AWG)	200	110
<b>Voltage Rating AC/DC</b>		
UL 1977	600	
<b>Dielectric Withstanding Voltage</b>		
Volts AC	2,200	
<b>Avg. Mated Contact Resistance Milliohms <sup>1</sup></b>		
5 1/2" of 2 AWG Wire	0.136	
<b>UL Hot Plug Current Rating Amperes <sup>4</sup></b>		
250 Cycles at 120V DC	60A	

## MATERIALS

### Housing

Plastic Resin	Polycarbonate
Contact Retention Spring	Stainless Steel

### Housing Flammability Rating

UL94	V-0
Glow Wire	960°C (GWFI) / 850°C (GWIT)

### Contact

Base	Copper Alloy
Plating	Silver

### Contact Termination Methods

Crimp <sup>3</sup>	Wire Contacts
Hand Solder	Wire Contacts

## MECHANICAL

<b>Wire Size Range</b>	<b>AWG</b>	<b>mm<sup>2</sup></b>
Wire Contacts with Bushings	10 to 1/0	5.3 to 53.5
<b>Max. Wire Insulation Diameter</b>	<b>in.</b>	<b>mm</b>
	0.600	15.240
<b>Operating Temperature <sup>2</sup></b>	<b>°F</b>	<b>°C</b>
	-4° to 221°	-20° to 105°
<b>Mating Cycles No Load by Plating</b>	<b>Silver (Ag)</b>	
Wire Contacts	10,000	
<b>Avg. Mating / Unmating Force</b>	<b>Lbf.</b>	<b>N</b>
	8	36
<b>Min. Contact / Spring Retention Force</b>	<b>Lbf.</b>	<b>N</b>
	60	267



File No. E26221



CSA Certified  
File No. LR25154



NOTE 1: See IEC 60664-1 for working voltage.

NOTE 2: Amp ratings are stated per position and based on all positions being fully loaded.

- 1 - Based on: 105°C rated or better cable of the largest size. Properly calibrated APP® recommended tooling, and a 25°C ambient temperature. UL rating not to exceed the maximum operating temperature. CSA rating below a 30°C temperature rise.
- 2 - Limited by the thermal properties of the connector plastic housing.
- 3 - Use APP® recommended tooling only. Alternate tools may adversely affect the performance of our connectors along with UL and CSA recognition.
- 4 - Based on 2 housings blocked together.

## IEC INFORMATION

Connector Series	Configurations	Creepage / Clearance per IEC 60950-1	Material Group
PP120	Single Pole	Unmated	4.36 mm
		Mated	4.36 mm
	Stacked Powerpole®	Unmated	4.36 mm
		Mated	4.36 mm

## PROTECTION

### Touch Safety with Wire Contacts

IEC 60529	IP10
-----------	------



ATTRIBUTES	PP120
<b>AMP Rating AC/DC</b>	120
<b>Voltage Rating AC/DC (Steady State)</b>	400 V AC/DC (Operational)
<b>Breaking Capacity - AMP Rating / Cycles</b>	120 Amp / 10 Cycles
<b>Voltage Rating (Breaking Capacity)</b>	220 VDC
<b>FINGER Safety - Mated Only</b>	IEC 60529- IP20
<b>Wire Size Tested</b>	50 mm <sup>2</sup>
<b>Contact Series Tested</b>	1323G2
<b>Climatic Testing (Cold, Heat &amp; MFG)</b>	IEC 60512 Test- 11j, 11i & 11g
<b>Cycle Life</b>	IEC 60512 Test 9a- 5,000 Cycles
<b>Mechanical Strength Impact</b>	IEC 60512-5 @ 29.5 Inches-Dropped 8 times
<b>Temperature Range</b>	-20°C to 105°C -4°F to 221°F

# POWERPOLE® PP120 ACCESSORIES

## Mounting Clamp

Mounting clamps can be used for fastening a block of Powerpole® 120 series housings to a panel. Connector blocks must be a complete square for the clamps to work properly. Fastening hardware not included.

Description	Part Numbers
Minimum Quantity	20 sets of 2
2 Pole	1464G1
3 Pole	1464G2

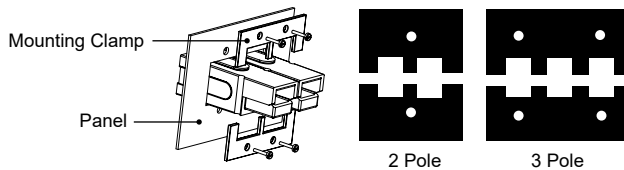

## Retaining Pins

Retaining pins are used to keep stacked Powerpole® 120 series housings from separating. Retaining pins are inserted in the circular opening between two housings stacked side by side. Dimension B is +/- 0.015 in or 0.38 mm.

Description	Part Numbers		Dimensions			
			- A -		- B -	
	inches	mm	inches	mm	inches	mm
Minimum Quantity	1,000	100				
1 Block High	111812P7	110G19	0.196 / 0.207	4.98 / 5.26	0.560	14.220
2 Block High	111812P8	110G20	0.196 / 0.207	4.98 / 5.26	1.500	38.100

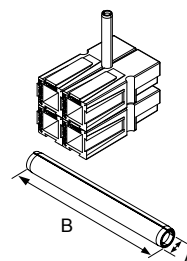

## Reducing Bushings

Use with contact part number 1319-BK to allow a smaller wire to be used with the connector. Electrical capability is derated with smaller wire.

Contact Barrel Size		Wire Size		Part Numbers			Dimensions - ID -	
AWG	mm <sup>2</sup>	AWG	mm <sup>2</sup>				inches	mm
Minimum Quantity				2,000	1,000	100		
2	33.6	4	21.2	5919-BK	-	5919	0.28	7.11
2	33.6	6	16	-	5920-BK	5920	0.23	5.84
2	33.6	10 to 8	5.3 to 8.4	5921-BK		5921	0.18	4.57

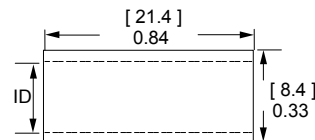

NOTE: Combination of a bushing and contact is not UL approved.

For environmentally sealed connector shells to hold Powerpole® 15 to 180 connectors, see SPEC Pak® product series on our website [www.andersonpower.com](http://www.andersonpower.com)



# Powerpole®

Tooling Information - APP® Applicators are Mechanical Feed Style and do not Require an Air Feed Kit.

POWERPOLE® TOOLING

Wire Size		Loose Piece Part Number		Loose Piece Contact Crimp Tools							
AWG	mm <sup>2</sup>	Tin Plating	Silver Plating	Hand Tool	OR	Pneumatic Bench Tool	+	Die	+	Locator	Number of Crimps
<b>PP15 / 45 Flat Wiping Power &amp; Ground</b>											
16 to 20	1.3 to 0.52	N/A	1332	1309G2 or 1309G8							Single
12 to 16	3.3 to 1.3	N/A	1331								
16 to 20	1.3 to 0.52	262G1-LPBK	262G2-LPBK								
16 to 20	1.3 to 0.52	269G2-LPBK	N/A								
12 to 16	3.3 to 1.3	261G1-LPBK	N/A	1309G3 or 1309G8		N/A		N/A			Single
10 to 14	5.3 to 2.1	261G2-LPBK	261G3-LPBK								
12 to 16	3.3 to 1.3	269G1-LPBK	N/A								
10 to 14	5.3 to 2.1	269G3-LPBK	N/A	1309G6 or 1309G8							Single
10 to 14	5.3 to 2.1	200G1L-LPBK	200G3L-LPBK								
10 to 14	5.3 to 2.1	201G1H-LPBK	N/A								
310 to 14	5.3 to 2.1	1830G1-LPBK	1830G2-LPBK								
<b>PP75</b>											
6	13.3	N/A	1307	1309G4		1387G1		1388G6		1389G6	Single
			5900								
8	8.4		1875G1								
			5952								
			1875G2								
10 to 12	5.3 to 3.3		5953								
			5915								
			1875G3								
								1388G7		1389G6	
										1389G21	
<b>PP120</b>											
1/0	53.5	N/A	1323G2	1368 Series		1387G1		1388G3		1389G4	Single
1	42.4		1323G1								
2	33.6		1319								
4	21.2		1319G4								
6	13.3		1319G6								
								1388G4			
<b>PP180</b>											
3/0	85	N/A	1328G2	1368 Series		1387G2		1303G12		1304G32	Double
2/0	53.5		1328G1								
1/0	53.5		1382								
1	42.4		1347								
2	33.6		1383								
4	21.1		1384								
6	13.3		1348								
								1303G13			
						1387G1		1388G4		1389G3	Single

Insertion / Extraction Tool for PP15/45 Contacts = 111038G2

NOTE: see website for the most current information.

Wire Size		Reeled Part Number		Reeled Contact Crimp Tools		
AWG	mm <sup>2</sup>	Tin Plating	Silver Plating	APP <sup>®</sup> Applicator	+	APP <sup>®</sup> Press
<b>PP15/45 Flat Wiping Power &amp; Ground</b>						
16 to 20	1.3 to 0.52	262G1	262G2	TD0101		115V = TE0101 230V = TE0102
16 to 20	1.3 to 0.52	269G2	N/A			
12 to 16	3.3 to 1.3	261G1	N/A			
10 to 14	5.3 to 2.1	261G2	261G3			
12 to 16	3.3 to 1.3	269G1	N/A			
10 to 14	5.3 to 2.1	269G3	N/A			
10 to 14	5.3 to 2.1	200G1L	200G3L	TD0102		
10 to 14	5.3 to 2.1	201G1H	N/A			
10 to 14	5.3 to 2.1	1830G1	1830G2			

### Your Best Connection™

2020-0055 DS-PP120 REV C7

Anderson™ will use reasonable efforts to include accurate and up-to-date content in the data sheet. All product information contained in the data sheet including ordering information, illustrations, specifications, and dimensions, are believed to be reliable as of the date of publishing, but is subject to change without notice. Anderson™ makes no warranty or representation as to its accuracy. Content in the data sheet may contain technical inaccuracies, typographical errors and may be changed or updated without notice. Anderson™ may also make improvements and/or changes to the products and/or to the programs described in the content at any time without notice. Current sales drawings and specifications are available upon request.

©2020 Anderson Power Products, Inc. All rights reserved. APP®, A®, Anderson Power Products®, Powerpole®, SPEC Pak® and the APP Logo are registered trademarks of Anderson Power Products, Inc. Anderson™ and Your Best Connection™ are trademarks of Anderson Power Products, Inc.

# Mouser Electronics

Authorized Distributor

Click to View Pricing, Inventory, Delivery & Lifecycle Information:

## Anderson Power Products:

[111812P7](#) [111812P8](#) [1327G7-BK](#) [1327G8](#) [441G1](#) [441G3](#) [444g1](#) [1319-BK](#) [1319G4](#) [1319G4-BK](#) [1319G6](#)  
[1319G6-BK](#) [1323G2](#) [1323G2-BK](#) [5919-BK](#) [5921](#) [5921-BK](#) [SBE80HDLRED](#) [SBO60HDLRED](#) [110G20](#) [1321](#) [1321-](#)  
[BK](#) [1321G1](#) [1321G1-BK](#) [1321G2](#) [1321G2-BK](#) [1321G3](#) [1321G3-BK](#) [1321G4](#) [1321G4-BK](#) [1321G8](#) [1464G1](#)  
[1464G2](#) [4803G3-BK](#) [4827G6-BK](#) [PM16P2024A30](#) [4802G3](#) [4803G3](#) [4827G6](#) [3-5956P1](#) [4802G3-BK](#) [6396G1](#)  
[1321G8-BK](#) [113715P4](#) [113716P3](#) [113952P1](#) [3-5798P1](#) [1321G6](#) [1321G6-BK](#) [1321G7](#) [1321G5](#) [1321G5-BK](#)  
[H1835P3](#)