

Chip Wire Wound Common Mode Choke

ACM-31



RoHS
Compliant



3.2 x 1.6 x 1.8mm

FEATURES:

- Small size with ferrite base
- Two line type wire wound
- High common-mode impedance at noise band and low differential-mode impedance at signal band
- Suitable for high-speed signal.

APPLICATIONS:

- EMI and Noise Suppression
- USB Line Filter for Personal Computers and Peripheral
- IEEE 1394 Line for Personal Computers, DVC, STB
- Low-Voltage Differential Signal (LVDS) for LCD panels

STANDARD SPECIFICATIONS

| | |
|-----------------------------------|---|
| Abrakon P/N: | ACM-31 |
| Operating Temperature & Humidity: | -40°C to +85°C |
| Storage Temperature & Humidity: | 22°C to 28°C, Humidity < 80%RH (In tape and reel) |

| Part Number | Z | DCR | IDC | Rated Voltage | Withstanding Voltage | Insulation Resistance |
|-------------|-------------------|-----------------|-----|---------------|----------------------|-----------------------|
| Units | $\Omega \pm 20\%$ | Ω (max.) | mA | Vdc | Vdc | M Ω (min.) |
| ACM-31-900 | 90 | 0.30 | 370 | 50 | 125 | 10 |
| ACM-31-121 | 120 | 0.30 | 370 | 50 | 125 | 10 |
| ACM-31-161 | 160 | 0.40 | 340 | 50 | 125 | 10 |
| ACM-31-261 | 260 | 0.50 | 310 | 50 | 125 | 10 |
| ACM-31-601 | 600 | 0.80 | 260 | 50 | 125 | 10 |
| ACM-31-102 | 1000 | 1.00 | 230 | 50 | 125 | 10 |
| ACM-31-222 | 2200 | 1.20 | 200 | 50 | 125 | 10 |

Test Conditions

Impedance: LCR Meter HP 4291B, 100MHz

DCR: Micro-Ohm meter (GOM-801G)

Withstand Voltage (VDC): 125Vdc, 60 sec, 0.5mA

Rated Voltage (VDC): 50Vdc, 1 – 5 sec

Insulation Resistance (I.R): 1mA, 1 min

PART IDENTIFICATION:

ACM-31 - M -



Impedance Code

Please refer to the table above

Packaging

Blank: bulk
T: Tape and Reel
(2k pcs/reel)

Chip Wire Wound Common Mode Choke

ACM-31



RoHS
Compliant



3.2 x 1.6 x 1.8mm

CHARACTERISTIC CURVE:

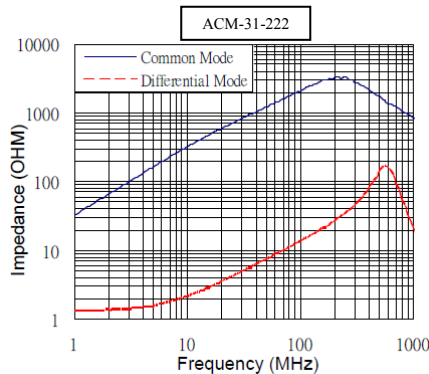
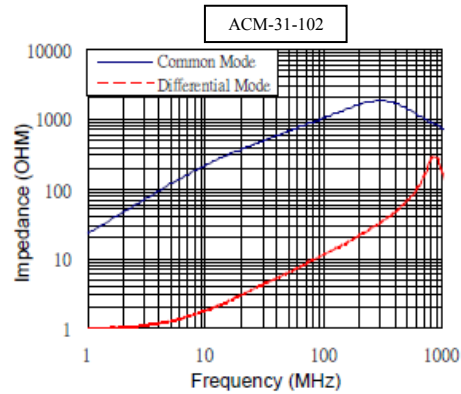
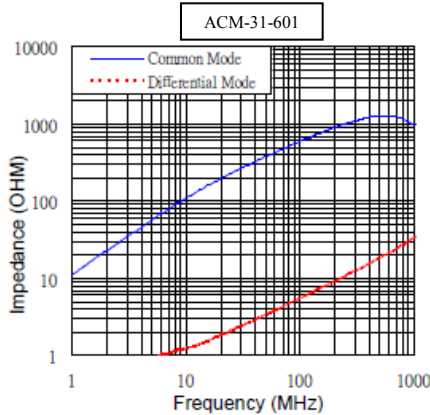
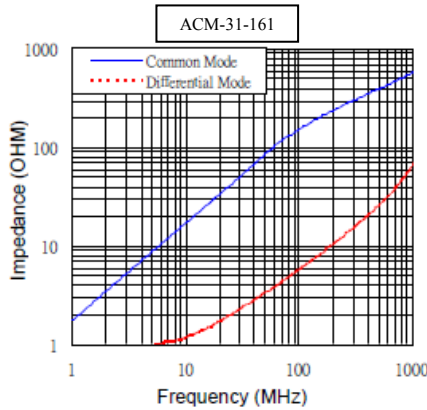
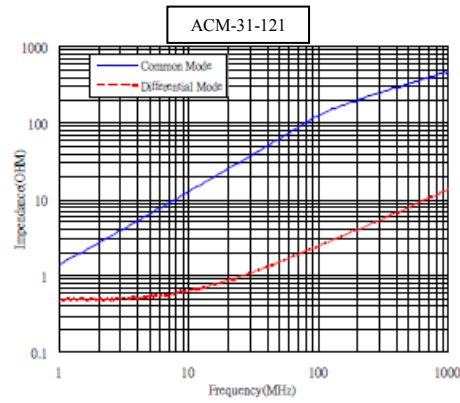

ABRACON IS
ISO 9001:2008
CERTIFIED



ABRACON
CORPORATION

Visit www.abracon.com for Terms & Conditions of Sale
30332 Esperanza, Rancho Santa Margarita, California 92688
tel 949-546-8000 | fax 949-546-8001 | www.abracon.com

Revised: 01.28.13

Chip Wire Wound Common Mode Choke

ACM-31



RoHS
Compliant



3.2 x 1.6 x 1.8mm

OUTLINE DIMENSIONS:



Recommended Land Pattern



| A | B | C | E | F | G |
|---------|---------|---------|------|-----|-----|
| 3.0±0.2 | 1.6±0.2 | 1.8±0.2 | 0.60 | 2.0 | 0.6 |

| H | I | J | K |
|-----|-----|-----|------|
| 1.6 | 0.6 | 0.4 | 1.05 |

Schematic

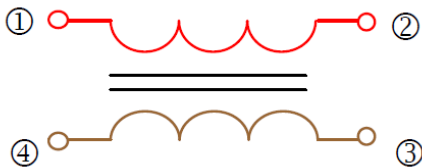

Dimension: mm

REFLOW PROFILE:

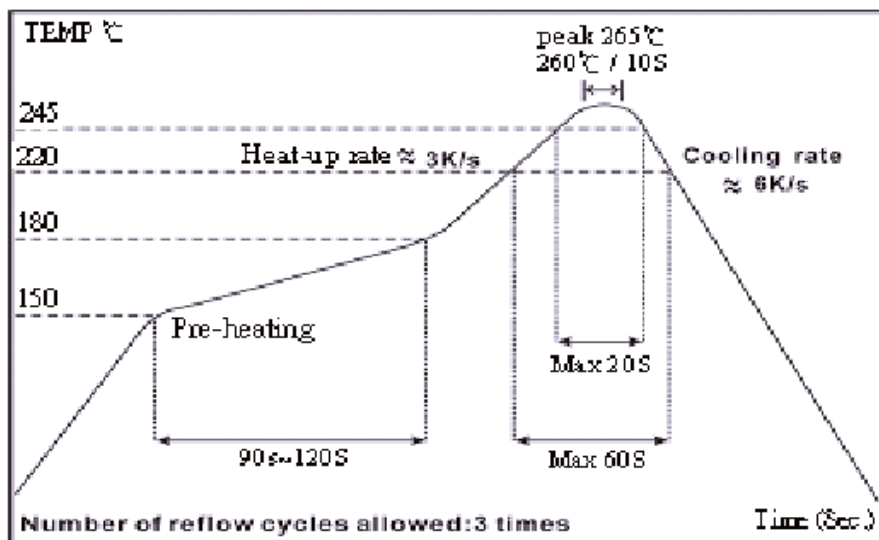

Chip Wire Wound Common Mode Choke

ACM-31



RoHS
Compliant



3.2 x 1.6 x 1.8mm

TAPE & REEL: 2000pcs/reel



| A | B | W | E | F | P0 | P1 | P2 | ΦD0 | t |
|-----------|-----------|----------|-----------|----------|-----------|-----------|-----------|-----------|-----------|
| 1.90±0.10 | 3.50±0.05 | 8.0±0.20 | 1.75±0.10 | 3.5±0.10 | 4.00±0.10 | 4.00±0.10 | 2.00±0.10 | 1.50±0.10 | 2.10±0.10 |

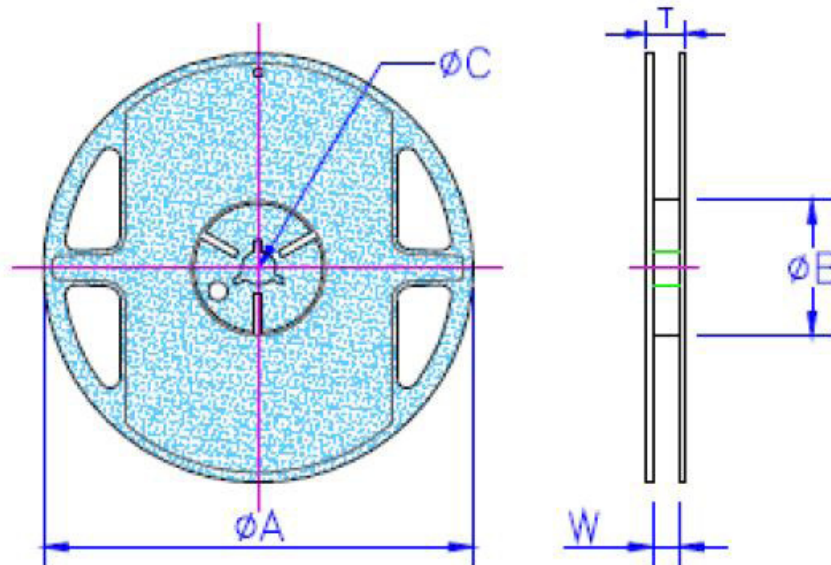

| ΦA | ΦB | ΦC | W | T |
|---------|--------|--------|-------|----------|
| 178±2.0 | 60±0.5 | 13±0.3 | 9±0.3 | 11.4±1.0 |

Dimension: mm

ATTENTION: Abracon Corporation's products are COTS – Commercial-Off-The-Shelf products; suitable for Commercial, Industrial and, where designated, Automotive Applications. Abracon's products are not specifically designed for Military, Aviation, Aerospace, Life-dependant Medical applications or any application requiring high reliability where component failure could result in loss of life and/or property. For applications requiring high reliability and/or presenting an extreme operating environment, written consent and authorization from Abracon Corporation is required. Please contact Abracon Corporation for more information.

ABRACON IS
ISO 9001:2008
CERTIFIED



Visit www.abracon.com for Terms & Conditions of Sale **Revised: 01.28.13**
30332 Esperanza, Rancho Santa Margarita, California 92688
tel 949-546-8000 | fax 949-546-8001 | www.abracon.com

Mouser Electronics

Authorized Distributor

Click to View Pricing, Inventory, Delivery & Lifecycle Information:

ABRACON:

[ACM-31-900M-T](#) [ACM-31-261M-T](#) [ACM-31-601M-T](#) [ACM-31-121M-T](#) [ACM-31-161M-T](#) [ACM-31-222M-T](#) [ACM-31-102M-T](#)