

## N-Channel Enhancement Mode Field Effect Transistor

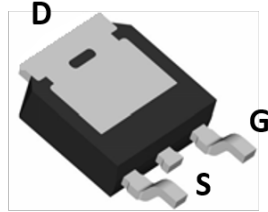

**TO-252**

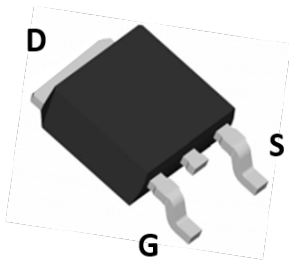
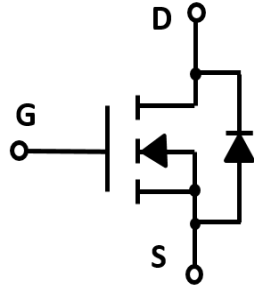

### Product Summary

- $V_{DS}$  40 V
- $I_D$  120 A
- $R_{DS(ON)}$ ( at  $V_{GS}=10V$ ) < 3.5 mohm
- $R_{DS(ON)}$ ( at  $V_{GS}=4.5V$ ) < 4.8 mohm
- 100% UIS Tested
- 100%  $\nabla V_{DS}$  Tested

### General Description

- Trench Power LV MOSFET technology
- Excellent package for heat dissipation
- High density cell design for low  $R_{DS(ON)}$

### Applications

- DC-DC Converters
- Power management functions
- Backlighting

### ■ Absolute Maximum Ratings ( $T_A=25^\circ\text{C}$ unless otherwise noted)

Parameter		Symbol	Limit	Unit
Drain-source Voltage		$V_{DS}$	40	V
Gate-source Voltage		$V_{GS}$	$\pm 20$	V
Drain Current	$T_C=25^\circ\text{C}$	$I_D$	120	A
	$T_C=100^\circ\text{C}$		76	
Pulsed Drain Current <sup>A</sup>		$I_{DM}$	390	A
Total Power Dissipation @ $T_C=25^\circ\text{C}$ <sup>B</sup>		$P_D$	110	W
Total Power Dissipation @ $T_C=100^\circ\text{C}$ <sup>B</sup>		$P_D$	44	W
Total Power Dissipation @ $T_A=25^\circ\text{C}$ <sup>C</sup>		$P_D$	6.2	W
Single Pulse Avalanche Energy <sup>D</sup>		$E_{AS}$	272	mJ
Thermal Resistance Junction-to-Case		$R_{\theta JC}$	1.14	$^\circ\text{C}/\text{W}$
Thermal Resistance Junction-to-Ambient		$R_{\theta JA}$	20	$^\circ\text{C}/\text{W}$
Junction and Storage Temperature Range		$T_J, T_{STG}$	-55~+150	$^\circ\text{C}$

### ■ Ordering Information (Example)

PREFERRED P/N	PACKING CODE	Marking	MINIMUM PACKAGE(pcs)	INNER BOX QUANTITY(pcs)	OUTER CARTON QUANTITY(pcs)	DELIVERY MODE
YJD120N04A	F2	YJD120N04A	2500	/	25000	13" reel



# YJD120N04A

## ■ Electrical Characteristics (T<sub>J</sub>=25°C unless otherwise noted)

Parameter	Symbol	Conditions	Min	Typ	Max	Units
<b>Static Parameter</b>						
Drain-Source Breakdown Voltage	BV <sub>DSS</sub>	V <sub>GS</sub> = 0V, I <sub>D</sub> =250μA	40			V
Zero Gate Voltage Drain Current	I <sub>DSS</sub>	V <sub>DS</sub> =40V, V <sub>GS</sub> =0V			1	μA
Gate-Body Leakage Current	I <sub>GSS</sub>	V <sub>GS</sub> = ±20V, V <sub>DS</sub> =0V			±100	nA
Gate Threshold Voltage	V <sub>GS(th)</sub>	V <sub>DS</sub> = V <sub>GS</sub> , I <sub>D</sub> =250μA	1.0	1.5	2.5	V
Static Drain-Source On-Resistance	R <sub>DS(ON)</sub>	V <sub>GS</sub> = 10V, I <sub>D</sub> =15A		2.8	3.5	mΩ
		V <sub>GS</sub> = 4.5V, I <sub>D</sub> =10A		4.0	4.8	
Diode Forward Voltage	V <sub>SD</sub>	I <sub>S</sub> =15A, V <sub>GS</sub> =0V		0.80	1.2	V
Maximum Body-Diode Continuous Current	I <sub>S</sub>				120	A
Gate resistance	R <sub>g</sub>	f=1 MHz, Open drain		3.1		Ω
<b>Dynamic Parameters</b>						
Input Capacitance	C <sub>iss</sub>	V <sub>DS</sub> =20V, V <sub>GS</sub> =0V, f=1MHZ		4645		pF
Output Capacitance	C <sub>oss</sub>			436		
Reverse Transfer Capacitance	C <sub>rss</sub>			360		
<b>Switching Parameters</b>						
Total Gate Charge	Q <sub>g</sub> (10V)	V <sub>GS</sub> =10V, V <sub>DS</sub> =20V, I <sub>D</sub> =20A		102		nC
Total Gate Charge	Q <sub>g</sub> (4.5V)			49		
Gate-Source Charge	Q <sub>gs</sub>			15.8		
Gate-Drain Charge	Q <sub>gd</sub>			21.9		
Reverse Recovery Charge	Q <sub>rr</sub>	I <sub>F</sub> =20A, di/dt=100A/us		7.4		
Reverse Recovery Time	t <sub>rr</sub>			22.3		
Turn-on Delay Time	t <sub>D(on)</sub>	V <sub>GS</sub> =10V, V <sub>DD</sub> =20V, I <sub>D</sub> =20A R <sub>GEN</sub> =3Ω		12		ns
Turn-on Rise Time	t <sub>r</sub>			54		
Turn-off Delay Time	t <sub>D(off)</sub>			120		
Turn-off fall Time	t <sub>f</sub>			80		

A. Pulse Test: Pulse Width ≤ 300us, Duty cycle ≤ 2%.

B. The power dissipation P<sub>D</sub> is based on T<sub>J(MAX)</sub>=150°C, using junction-to-case thermal resistance, and is more useful in setting the upper dissipation limit for cases where additional heatsinking is used.

C. The value of R<sub>θJA</sub> is measured with the device mounted on 1in2 FR-4 board with 2oz. Copper, in a still air environment with T<sub>A</sub>=25°C.

D. T<sub>J</sub>=25°C, V<sub>DD</sub>=40V, V<sub>G</sub>=10V, L=0.5mH.



## ■ Typical Performance Characteristics

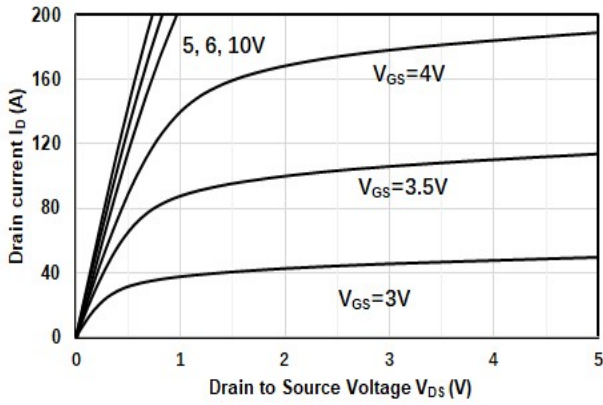

Figure1. Output Characteristics

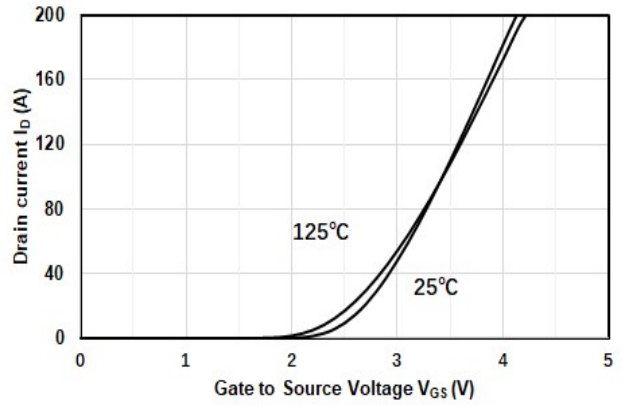

Figure2. Transfer Characteristics

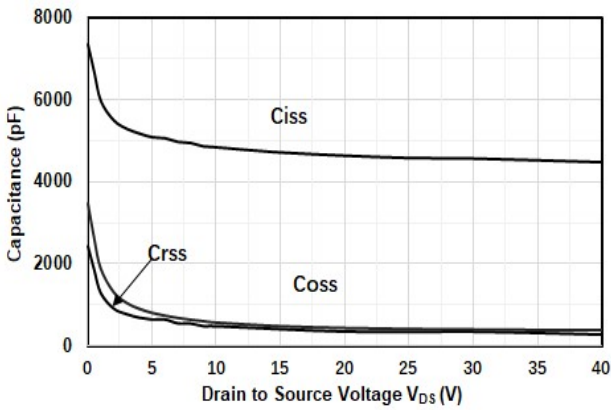

Figure3. Capacitance Characteristics

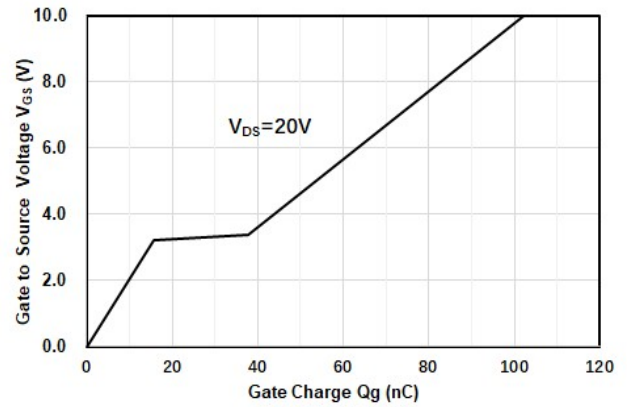

Figure4. Gate Charge

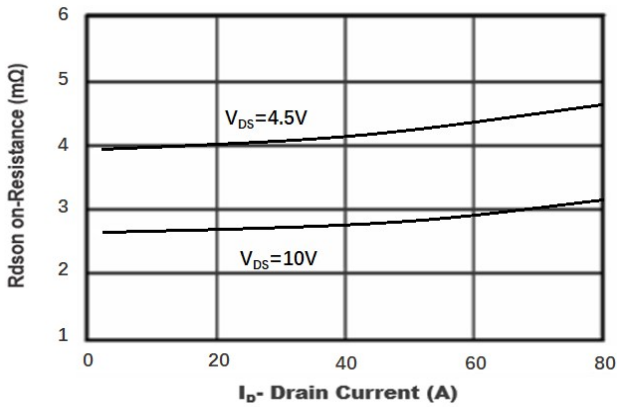

Figure5. Drain-Source on Resistance

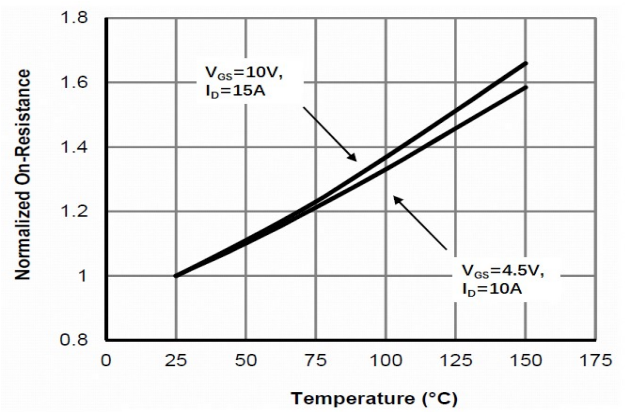

Figure6. Drain-Source on Resistance



# YJD120N04A

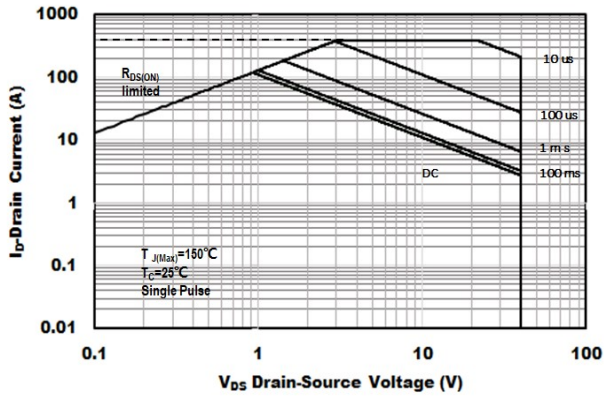

Figure7. Safe Operation Area

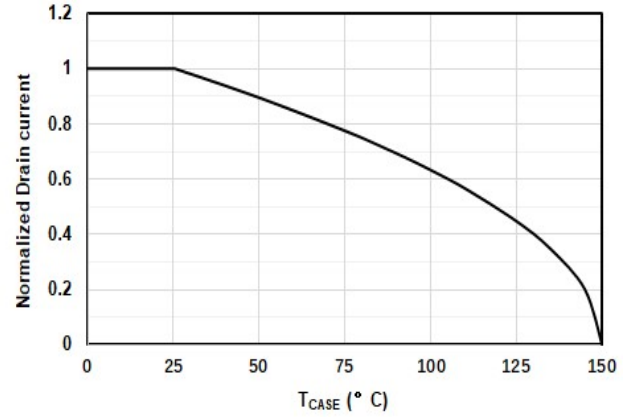

Figure8. Drain current vs. Case Temperature

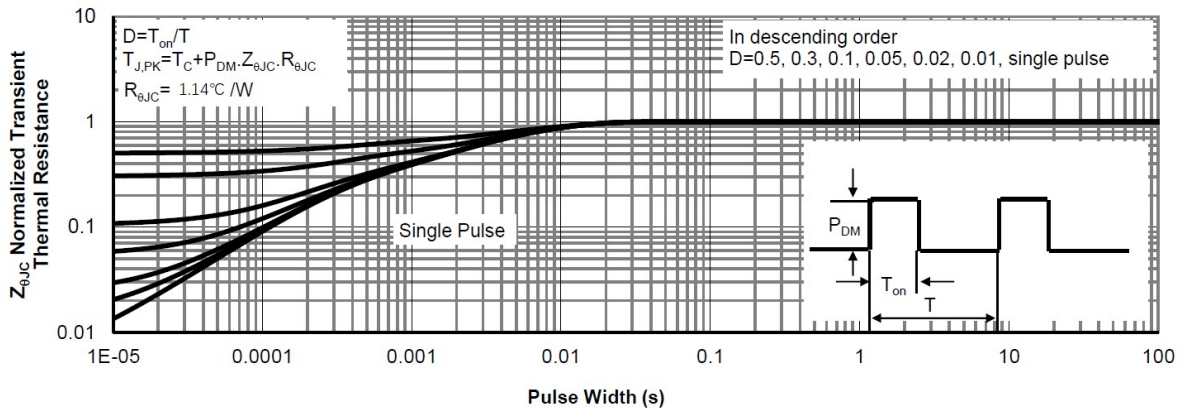
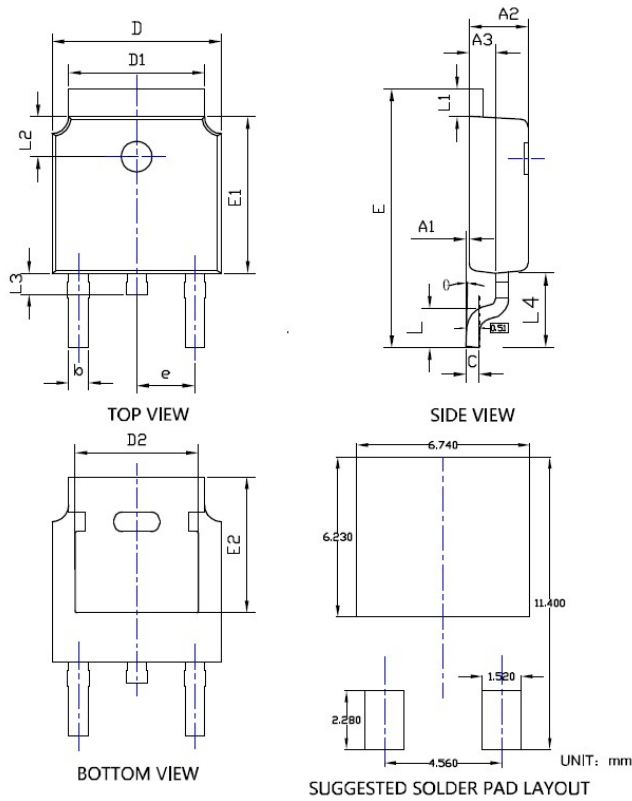

Figure9. Normalized Maximum Transient Thermal Impedance



# YJD120N04A

## TO-252 Package information



SYMBOL	DIMENSIONS					
	INCHES			Millimeter		
	MIN.	NOM.	MAX.	MIN.	NOM.	MAX.
A1	0.000	---	0.008	0.000	---	0.200
A2	0.087	0.091	0.094	2.200	2.300	2.400
A3	0.035	0.039	0.043	0.900	1.000	1.100
b	0.026	0.030	0.034	0.660	0.760	0.860
c	0.018	0.020	0.023	0.460	0.520	0.580
D	0.256	0.260	0.264	6.500	6.600	6.700
D1	0.203	0.209	0.215	5.150	5.300	5.450
D2	0.181	0.189	0.195	4.600	4.800	4.950
E	0.390	0.398	0.406	9.900	10.100	10.300
E1	0.236	0.240	0.244	6.000	6.100	6.200
E2	0.203	0.209	0.215	5.150	5.300	5.450
e	0.090BSC			2.286BSC		
L	0.049	0.059	0.069	1.250	1.500	1.750
L1	0.035	---	0.050	0.900	---	1.270
L2	0.055	---	0.075	1.400	---	1.900
L3	0.240	0.310	0.039	0.600	0.800	1.000
L4	0.114REF			2.900REF		
⊖	0*	---	10*	0*	---	10*

NOTE:  
 1. PACKAGE BODY SIZES EXCLUDE MOLD FLASH AND GATE BURRS.  
 2. TOLERANCE 0.1mm UNLESS OTHERWISE SPECIFIED.  
 3. THE PAD LAYOUT IS FOR REFERENCE PURPOSES ONLY.



## YJD120N04A

---

### Disclaimer

The information presented in this document is for reference only. Yangzhou Yangjie Electronic Technology Co., Ltd. reserves the right to make changes without notice for the specification of the products displayed herein to improve reliability, function or design or otherwise.

The product listed herein is designed to be used with ordinary electronic equipment or devices, and not designed to be used with equipment or devices which require high level of reliability and the malfunction of which would directly endanger human life (such as medical instruments, transportation equipment, aerospace machinery, nuclear-reactor controllers, fuel controllers and other safety devices), Yangjie or anyone on its behalf, assumes no responsibility or liability for any damages resulting from such improper use of sale.

This publication supersedes & replaces all information previously supplied. For additional information, please visit our website [http:// www.21yangjie.com](http://www.21yangjie.com) , or consult your nearest Yangjie's sales office for further assistance.