



# US1AF THRU US1MF

Reverse Voltage - 50 to 1000 Volts Forward Current - 1.0 Ampere

## SURFACE MOUNT ULTRA FAST RECTIFIER

### Features

- ◆ The plastic package carries Underwriters Laboratory Flammability Classification 94V-0
- ◆ For surface mounted applications
- ◆ Ultra fast switching for high efficiency
- ◆ Low reverse leakage
- ◆ Built-in strain relief, ideal for automated placement
- ◆ High forward surge current capability
- ◆ High temperature soldering guaranteed  
250 °C/10 seconds at terminals

### Mechanical Data

**Case** : JEDEC SMAF Molded plastic body

**Terminals** : Solder plated, solderable per MIL-STD-750, Method 2026

**Polarity** : Polarity symbol marking on body

**Mounting Position** : Any

**Weight** : 0.00095ounce, 0.027 grams

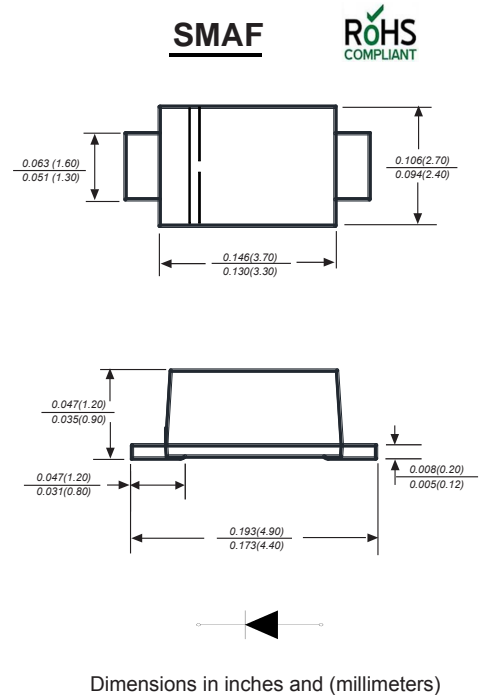

### Maximum Ratings And Electrical Characteristics

Ratings at 25°C ambient temperature unless otherwise specified.

Single phase half-wave 60Hz, resistive or inductive load, for capacitive load current derate by 20%.

Parameter	SYMBOLS	MDD US1AF	MDD US1BF	MDD US1DF	MDD US1GF	MDD US1JF	MDD US1KF	MDD US1MF	UNITS
Marking Code									
Maximum repetitive peak reverse voltage	$V_{RRM}$	50	100	200	400	600	800	1000	V
Maximum RMS voltage	$V_{RMS}$	35	70	140	280	420	560	700	V
Maximum DC blocking voltage	$V_{DC}$	50	100	200	400	600	800	1000	V
Maximum average forward rectified current at $T_L=125^\circ\text{C}$	$I_{(AV)}$	1.0							A
Peak forward surge current 8.3ms single half sine-wave superimposed on rated load (JEDEC Method)	$I_{FSM}$	30							A
Maximum instantaneous forward voltage at 1.0A	$V_F$	1.0		1.3		1.65		V	
Maximum DC reverse current $T_A=25^\circ\text{C}$ at rated DC blocking voltage $T_A=125^\circ\text{C}$	$I_R$	5.0 100							mA
Maximum reverse recovery time (NOTE 1)	$t_{rr}$	50				75			ns
Typical junction capacitance (NOTE 2)	$C_J$	15.0							pF
Typical thermal resistance (NOTE 3)	$R_{\theta JA}$	80.0							$^\circ\text{C}/\text{W}$
Operating junction and storage temperature range	$T_J, T_{STG}$	-55 to +150							$^\circ\text{C}$

**Note:** 1.Reverse recovery condition  $I_F=0.5\text{A}, I_R=1.0\text{A}, I_{rr}=0.25\text{A}$   
2.Measured at 1MHz and applied reverse voltage of 4.0V D.C.  
3.P.C.B. mounted with 2.0"x2.0" (5.0x5.0cm) copper pad areas



# US1AF THRU US1MF

Reverse Voltage - 50 to 1000 Volts Forward Current - 1.0 Ampere

## Ratings And Characteristic Curves

Fig.1 Forward Current Derating Curve

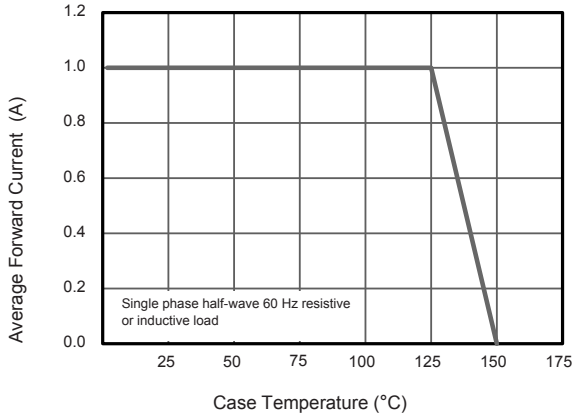

Fig.2 Typical Reverse Characteristics

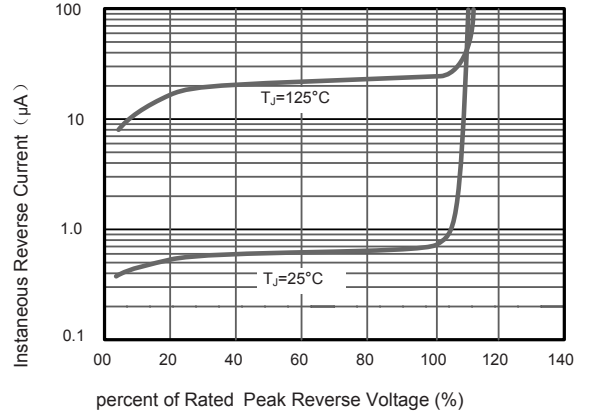

Fig.3 Typical Forward Characteristics

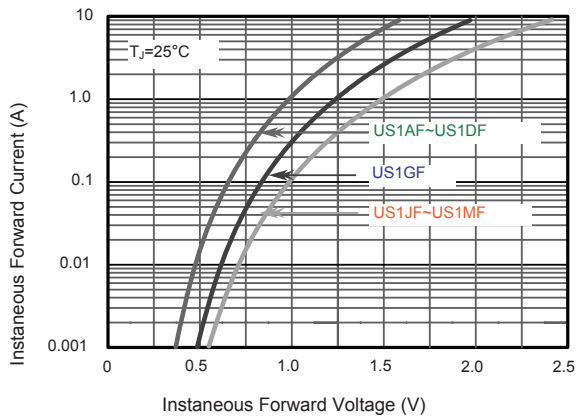

Fig.4 Maximum Non-Repetitive Peak Forward Surge Current

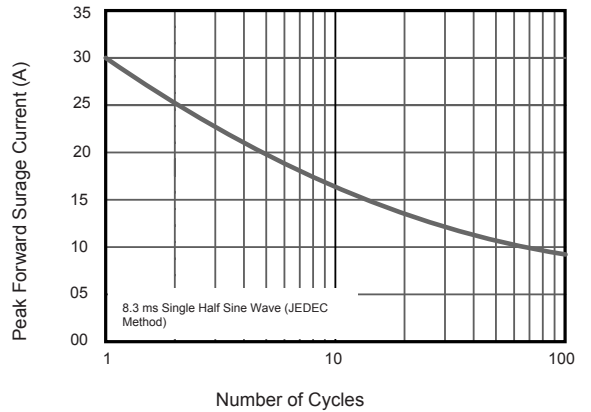
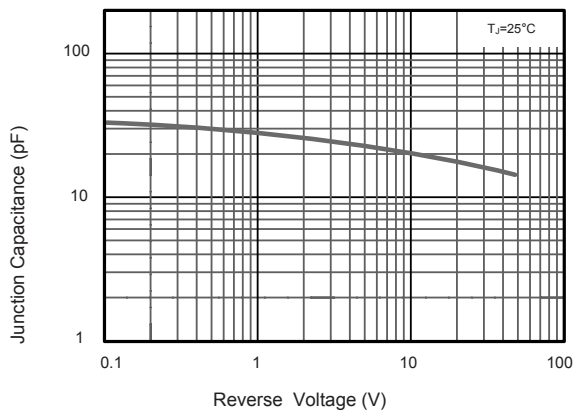

Fig.5 Typical Junction Capacitance



The curve above is for reference only.



# US1AF THRU US1MF

Reverse Voltage - 50 to 1000 Volts Forward Current - 1.0 Ampere

## Packing information

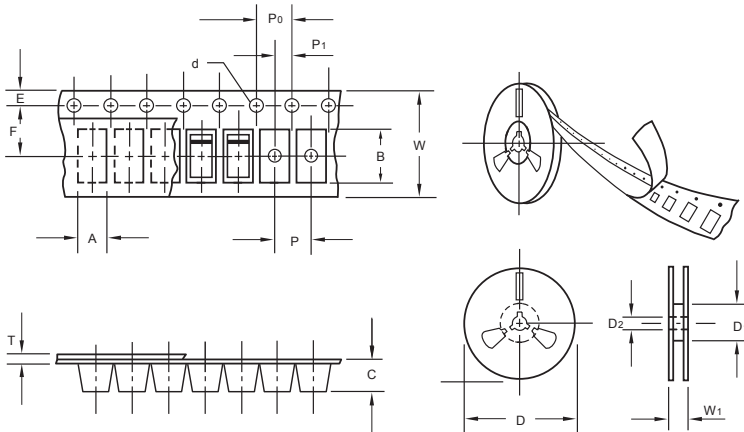

unit:mm

Item	Symbol	Tolerance	SMAF
Carrier width	A	0.1	2.80
Carrier length	B	0.1	4.75
Carrier depth	C	0.1	1.42
Sprocket hole	d	0.05	1.50
7" Reel outside diameter	D	2.0	178.00
7" Reel inner diameter	D <sub>1</sub>	min	54.40
Feed hole diameter	D <sub>2</sub>	0.5	13.00
Sprocket hole position	E	0.1	1.75
Punch hole position	F	0.1	5.05
Punch hole pitch	P	0.1	4.00
Sprocket hole pitch	P <sub>0</sub>	0.1	4.00
Embossment center	P <sub>1</sub>	0.1	2.00
Overall tape thickness	T	0.1	0.30
Tape width	W	0.3	8.00
Reel width	W <sub>1</sub>	1.0	12.30

Note: Devices are packed in accordance with EIA standard RS-481-A and specifications listed above.

## Reel packing

PACKAGE	REEL SIZE	REEL (pcs)	COMPONENT SPACING (m/m)	BOX (pcs)	INNER BOX (m/m)	REEL DIA. (m/m)	CARTON SIZE (m/m)	CARTON (pcs)	APPROX. GROSS WEIGHT (kg)
SMAF	7"	3,000	4.0	6,000	210*208*203	178	400*265*400	120,000	10.0

## Suggested Pad Layout



Symbol	Unit (mm)	Unit (inch)
A	1.8	0.071
B	1.6	0.063
C	3.8	0.150
D	2.2	0.087
E	5.4	0.213