

Inductors for power circuits
Thin-film metal magnetic material
TFM-ALMA series (for automotive)



AEC-Q200

TFM201610ALMA type



FEATURES

- By using metal magnetic material with high Saturation magnetic flux density the excellent DC bias characteristics needed for inductors for power circuits can be achieved.
- With the same product shape and terminal structure as general chip parts it has excellent mounting stability characteristics and can also be mounted to general-purpose land patterns.
- By using a closed magnetic circuit structure leakage flux is minimized.
- Compliant with AEC-Q200.

APPLICATION

- ADAS ECU, in-Vehicle camera (view camera, sensing camera), radar, meter cluster, automotive communication module
Other power supply circuit uses
- Application guides: [Automotive \(xEV\)](#), [Car Infotainment](#)

PART NUMBER CONSTRUCTION

TFM	201610	ALM	A	R47	M	T	AA
Series name	LxWxH dimensions 2.0x1.6x1.0 mm	Characteristic type	Automotive use	Inductance (μH)	Inductance tolerance	Packaging style	Internal code

CHARACTERISTICS SPECIFICATION TABLE

L (μH)	L measuring frequency Tolerance (MHz)	DC resistance (mΩ)max. (mΩ)typ.	Rated current*				Rated voltage (V)max.	Part No.		
			Isat (A)max. (A)typ.	Itemp (A)max. (A)typ.						
0.24	±20%	1	23	15	5.9	6.5	5.0	6.2	20	TFM201610ALMAR24MTAA
0.33	±20%	1	31	24	5.2	5.8	4.3	4.8	20	TFM201610ALMAR33MTAA
0.47	±20%	1	39	28	4.5	5.0	3.9	4.5	20	TFM201610ALMAR47MTAA
0.68	±20%	1	53	44	3.8	4.3	3.3	3.6	20	TFM201610ALMAR68MTAA
1.0	±20%	1	60	50	3.3	3.7	3.1	3.4	20	TFM201610ALMA1R0MTAA
1.5	±20%	1	110	85	2.8	3.1	2.3	2.6	20	TFM201610ALMA1R5MTAA
2.2	±20%	1	152	130	2.0	2.2	1.9	2.1	20	TFM201610ALMA2R2MTAA

* Rated current: smaller value of either Isat or Itemp.

Isat: When based on the inductance change rate (30% below the initial L value)

Itemp: When based on the temperature increase (temperature increase of 40°C by self heating)

Please contact us for the rated current vs. temperature characteristics (derating) at a product temperature of 85°C or higher.

Measurement equipment

Measurement item	Product No.	Manufacturer
L	4294A	Keysight Technologies
DC resistance	Digital Milliohm Meter	
Rated current Isat	4285A+42841A+42842C	Keysight Technologies

* Equivalent measurement equipment may be used.

TEMPERATURE RANGE, INDIVIDUAL WEIGHT

Operating temperature range*	Storage temperature range**	Individual weight
-55 to +150 °C	-55 to +150 °C	18 mg

* Operating temperature range includes self-temperature rise.

** The storage temperature range is for after the assembly.

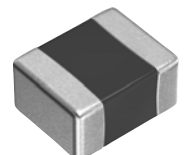

TFM201610ALMA type

L FREQUENCY CHARACTERISTICS

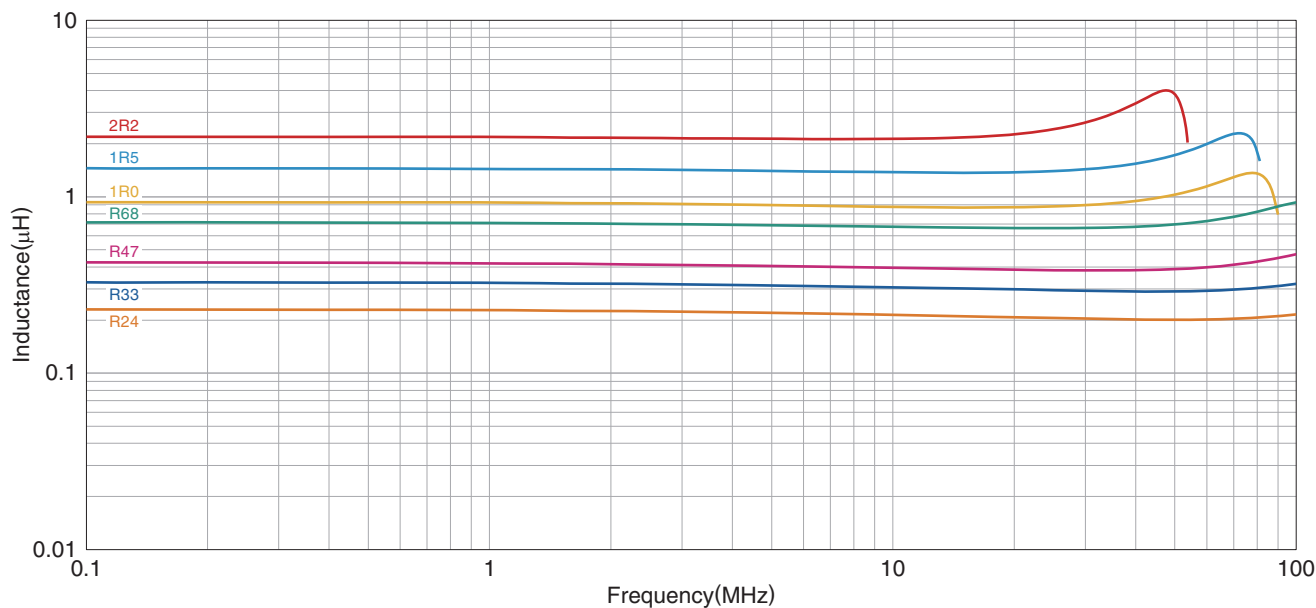

Measurement equipment

Product No.	Manufacturer
4294A	Keysight Technologies

* Equivalent measurement equipment may be used.

INDUCTANCE VS. DC BIAS CHARACTERISTICS

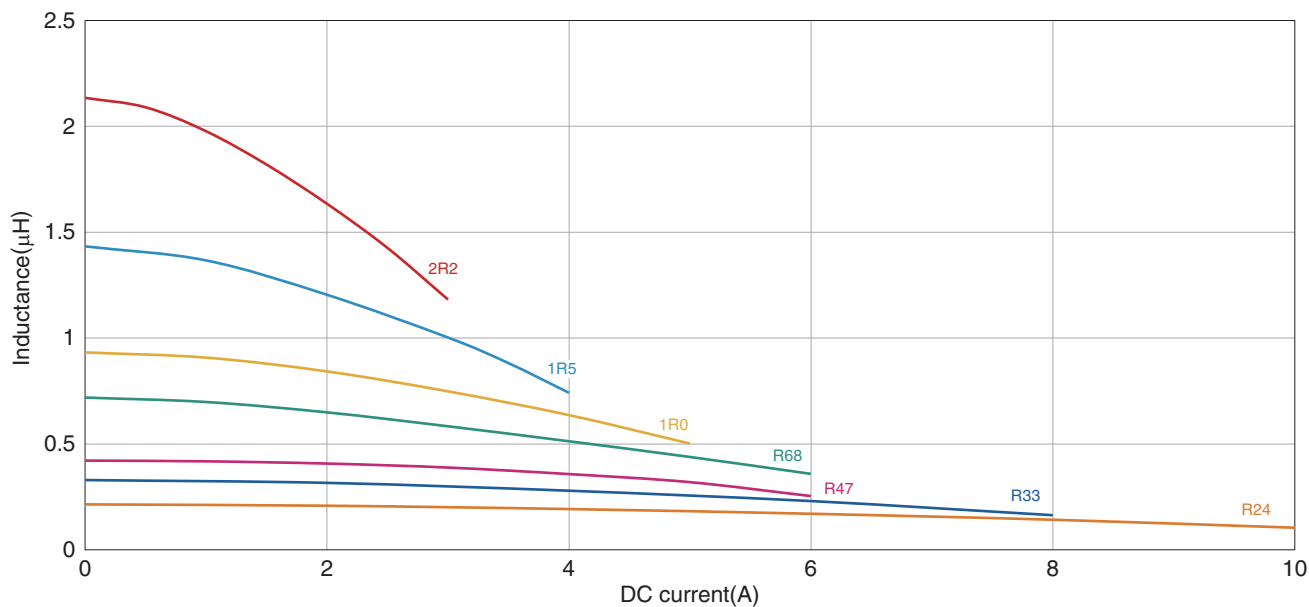

Measurement equipment

Product No.	Manufacturer
4285A+42841A+42842C	Keysight Technologies

* Equivalent measurement equipment may be used.

TFM201610ALMA type

SHAPE & DIMENSIONS

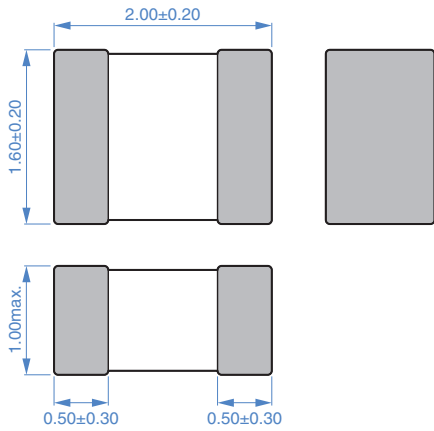

Dimensions in mm

RECOMMENDED LAND PATTERN

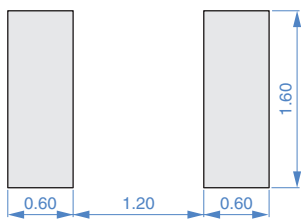

Dimensions in mm

RECOMMENDED REFLOW PROFILE

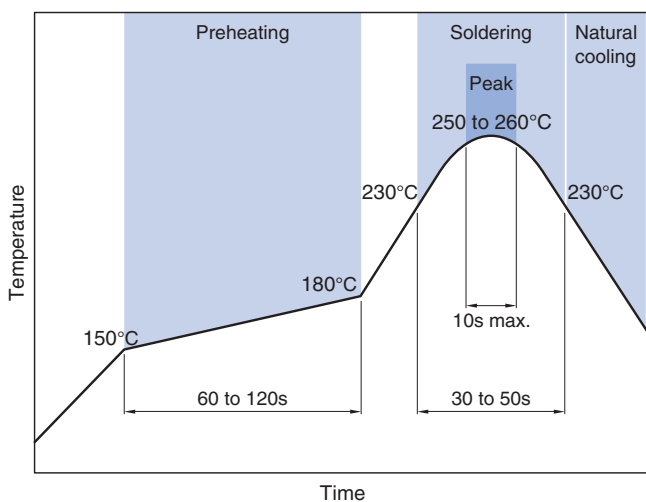

PACKAGING STYLE

REEL DIMENSIONS

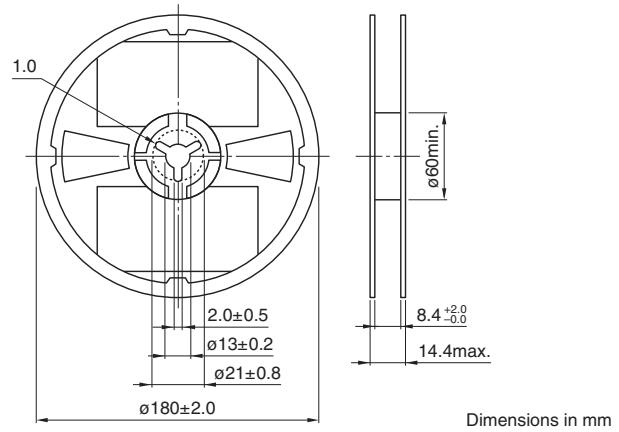

Dimensions in mm

TAPE DIMENSIONS

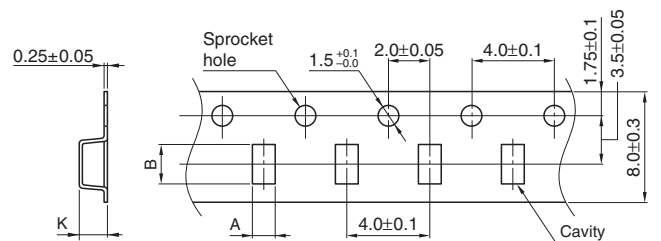

Dimensions in mm

Type	A	B	K
TFM201610ALMA	1.8	2.2	1.1

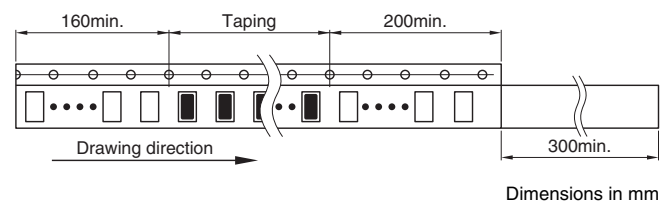

Dimensions in mm

PACKAGE QUANTITY

Package quantity	3000 pcs/reel
------------------	---------------

REMINDERS FOR USING THESE PRODUCTS

Before using these products, be sure to request the delivery specifications.

SAFETY REMINDERS

Please pay sufficient attention to the warnings for safe designing when using this products.

REMINDERS

- The storage period is within 6 months. Be sure to follow the storage conditions (temperature: 5 to 40°C, humidity: 20 to 75% RH or less).
If the storage period elapses, the soldering of the terminal electrodes may deteriorate.
- Do not use or store in locations where there are conditions such as gas corrosion (salt, acid, alkali, etc.).
- Before soldering, be sure to preheat components.
The preheating temperature should be set so that the temperature difference between the solder temperature and chip temperature does not exceed 150°C.
- Soldering corrections after mounting should be within the range of the conditions determined in the specifications.
If overheated, a short circuit, performance deterioration, or lifespan shortening may occur.
- When embedding a printed circuit board where a chip is mounted to a set, be sure that residual stress is not given to the chip due to the overall distortion of the printed circuit board and partial distortion such as at screw tightening portions.
- Self heating (temperature increase) occurs when the power is turned ON, so the tolerance should be sufficient for the set thermal design.
- Carefully lay out the coil for the circuit board design of the non-magnetic shield type.
A malfunction may occur due to magnetic interference.
- Use a wrist band to discharge static electricity in your body through the grounding wire.
- Do not expose the products to magnets or magnetic fields.
- Do not use for a purpose outside of the contents regulated in the delivery specifications.
- The products described in this catalog are intended to be installed in automobiles or automotive electronic equipment (AV equipment, telecommunications equipment, home appliances, amusement equipment, computer equipment, personal equipment, office equipment, measurement equipment, industrial robots) and to be used in automobiles (including the case where the said automotive product is mounted in a vehicle) or standard applications as general electronic equipment in automotive applications or standard applications as general electronic equipment in automotive applications in accordance with the scope and conditions described in this specification, while the said automotive or general electronic equipment including the said product is intended to be used in the usual operation and usage methods, respectively. Other than automotive or automotive products are not designed or warranted to meet the requirements of the applications listed below, whose performance and/or quality requires a more stringent level of safety or reliability, or whose failure, malfunction or defect could cause serious damage to society, person or property.
Please understand that we are not responsible for any damage or liability caused by use of the products in any of the applications below or for any other use exceeding the range or conditions set forth in this specification sheet.
If you intend to use the products in the applications listed below or if you have special requirements exceeding the range or conditions set forth in this specification, please contact us.

- (1) Aerospace/aviation equipment
- (2) Transportation equipment (electric trains, ships, etc.)
- (3) Medical equipment
- (4) Power-generation control equipment
- (5) Atomic energy-related equipment
- (6) Seabed equipment
- (7) Transportation control equipment

- (8) Public information-processing equipment
- (9) Military equipment
- (10) Electric heating apparatus, burning equipment
- (11) Disaster prevention/crime prevention equipment
- (12) Safety equipment
- (13) Other applications that are not considered general-purpose applications

When designing your equipment even for general-purpose applications, you are kindly requested to take into consideration securing protection circuit/device or providing backup circuits in your equipment.