



Optocoupler, Phototransistor Output, SOP-4L, Long Mini-Flat Package



17295-5



FEATURES

- SMD low profile 4 lead package
- $V_{IORM} = 1050\text{ V}$
- CTR flexibility available see order information
- Special construction
- Extra low coupling capacitance
- DC input with transistor output
- Creepage distance > 8 mm
- Material categorization:
for definitions of compliance please see www.vishay.com/doc?99912



DESCRIPTION

The TCLT100. series consists of a phototransistor optically coupled to a gallium arsenide infrared-emitting diode in a 4-lead SOP4L package.

APPLICATIONS

- Switchmode power supplies
- Computer peripheral interface
- Microprocessor system interface

AGENCY APPROVALS

- UL1577, file no. E76222
- CSA (cUL) 22.2 bulletin 5A recognized file no. E-76222
- BSI: BS EN 41003, BS EN 60065 (BS 415), BS EN 60950 (BS 7002), certificate number 7081 and 7402
- DIN EN 60747-5-5 (VDE 0884)
- FIMKO: EN 60950
- CQC

Note

- See the safety standard approval list "Agency Table" for more detailed information.

| ORDERING INFORMATION | | | | | | | | | |
|---|-----------|-----------|------------|------------|-----------|------------|-----------|------------|------------|
| <div style="display: flex; justify-content: space-around; align-items: center;"> <div style="border: 1px solid black; padding: 2px 5px;">T</div> <div style="border: 1px solid black; padding: 2px 5px;">C</div> <div style="border: 1px solid black; padding: 2px 5px;">L</div> <div style="border: 1px solid black; padding: 2px 5px;">T</div> <div style="border: 1px solid black; padding: 2px 5px;">1</div> <div style="border: 1px solid black; padding: 2px 5px;">0</div> <div style="border: 1px solid black; padding: 2px 5px;">0</div> <div style="border: 1px solid black; padding: 2px 5px;">#</div> </div> <p style="text-align: center; margin-top: 5px;">PART NUMBER</p> | | | | | | | | | |
| AGENCY CERTIFIED/PACKAGE | CTR (%) | | | | | | | | |
| | 5 mA | | | 10 mA | | | 5 mA | | |
| UL, cUL, VDE, BSI, FIMKO | 50 to 600 | 63 to 125 | 100 to 200 | 160 to 320 | 50 to 150 | 100 to 300 | 80 to 160 | 130 to 260 | 200 to 400 |
| SOP-4L | TCLT1000 | TCLT1002 | TCLT1003 | TCLT1004 | TCLT1005 | TCLT1006 | TCLT1007 | TCLT1008 | TCLT1009 |

Note

- Available only on tape and reel.



| ABSOLUTE MAXIMUM RATINGS ($T_{amb} = 25\text{ }^{\circ}\text{C}$, unless otherwise specified) | | | | |
|--|--------------------------------------|------------|-------------|--------------------|
| PARAMETER | CONDITION | SYMBOL | VALUE | UNIT |
| INPUT | | | | |
| Reverse voltage | | V_R | 6 | V |
| Forward current | | I_F | 60 | mA |
| Forward surge current | $t_p \leq 10\text{ }\mu\text{s}$ | I_{FSM} | 1.5 | A |
| Power dissipation | | P_{diss} | 100 | mW |
| Junction temperature | | T_j | 125 | $^{\circ}\text{C}$ |
| OUTPUT | | | | |
| Collector emitter voltage | | V_{CEO} | 70 | V |
| Emitter collector voltage | | V_{ECO} | 7 | V |
| Collector current | | I_C | 50 | mA |
| Collector peak current | $t_p/T = 0.5, t_p \leq 10\text{ ms}$ | I_{CM} | 100 | mA |
| Power dissipation | | P_{diss} | 150 | mW |
| Junction temperature | | T_j | 125 | $^{\circ}\text{C}$ |
| COUPLER | | | | |
| Total power dissipation | | P_{tot} | 250 | mW |
| Operating ambient temperature range | | T_{amb} | -55 to +100 | $^{\circ}\text{C}$ |
| Storage temperature range | | T_{stg} | -55 to +125 | $^{\circ}\text{C}$ |
| Soldering temperature | | T_{slid} | 260 | $^{\circ}\text{C}$ |

Note

- Stresses in excess of the absolute maximum ratings can cause permanent damage to the device. Functional operation of the device is not implied at these or any other conditions in excess of those given in the operational sections of this document. Exposure to absolute maximum ratings for extended periods of the time can adversely affect reliability.

| ELECTRICAL CHARACTERISTICS ($T_{amb} = 25\text{ }^{\circ}\text{C}$, unless otherwise specified) | | | | | | |
|--|--|-------------|------|------|------|------|
| PARAMETER | TEST CONDITION | SYMBOL | MIN. | TYP. | MAX. | UNIT |
| INPUT | | | | | | |
| Forward voltage | $I_F = 50\text{ mA}$ | V_F | - | 1.25 | 1.6 | V |
| Junction capacitance | $V_R = 0\text{ V}, f = 1\text{ MHz}$ | C_j | - | 50 | - | pF |
| OUTPUT | | | | | | |
| Collector emitter voltage | $I_C = 1\text{ mA}$ | V_{CEO} | 70 | - | - | V |
| Emitter collector voltage | $I_E = 100\text{ }\mu\text{A}$ | V_{ECO} | 7 | - | - | V |
| Collector emitter cut-off current | $V_{CE} = 20\text{ V}, I_F = 0\text{ A}$ | I_{CEO} | - | 10 | 100 | nA |
| COUPLER | | | | | | |
| Collector emitter saturation voltage | $I_F = 10\text{ mA}, I_C = 1\text{ mA}$ | V_{CEsat} | - | - | 0.3 | V |
| Cut-off frequency | $V_{CE} = 5\text{ V}, I_F = 10\text{ mA}, R_L = 100\text{ }\Omega$ | f_c | - | 110 | - | kHz |
| Coupling capacitance | $f = 1\text{ MHz}$ | C_k | - | 0.3 | - | pF |

Note

- Minimum and maximum values are testing requirements. Typical values are characteristics of the device and are the result of engineering evaluation. Typical values are for information only and are not part of the testing requirements.

| CURRENT TRANSFER RATIO ($T_{amb} = 25\text{ }^{\circ}\text{C}$, unless otherwise specified) | | | | | | | |
|---|---|----------|--------|------|------|------|------|
| PARAMETER | TEST CONDITION | PART | SYMBOL | MIN. | TYP. | MAX. | UNIT |
| I_C/I_F | $V_{CE} = 5\text{ V}, I_F = 5\text{ mA}$ | TCLT1000 | CTR | 50 | - | 600 | % |
| | | TCLT1002 | CTR | 63 | - | 125 | % |
| | $V_{CE} = 5\text{ V}, I_F = 10\text{ mA}$ | TCLT1003 | CTR | 100 | - | 200 | % |
| | | TCLT1004 | CTR | 160 | - | 320 | % |
| | $V_{CE} = 5\text{ V}, I_F = 1\text{ mA}$ | TCLT1002 | CTR | 22 | 45 | - | % |
| | | TCLT1003 | CTR | 34 | 70 | - | % |
| | | TCLT1004 | CTR | 56 | 100 | - | % |
| | $V_{CE} = 5\text{ V}, I_F = 5\text{ mA}$ | TCLT1005 | CTR | 50 | - | 150 | % |
| | | TCLT1006 | CTR | 100 | - | 300 | % |
| | | TCLT1007 | CTR | 80 | - | 160 | % |
| | | TCLT1008 | CTR | 130 | - | 260 | % |
| TCLT1009 | | CTR | 200 | - | 400 | % | |

| SAFETY AND INSULATION RATINGS | | | | |
|---|--|------------|-----------|--------------------|
| PARAMETER | CONDITION | SYMBOL | VALUE | UNIT |
| Partial discharge test voltage - routine test | 100 %, $t_{test} = 1\text{ s}$ | V_{pd} | 2 | kV |
| Partial discharge test voltage - lot test (sample test) | $t_{Tr} = 60\text{ s}, t_{test} = 10\text{ s}$, (see figure 2) | V_{IOTM} | 8 | kV _{peak} |
| | | V_{pd} | 1.68 | kV _{peak} |
| Isolation test voltage (RMS) | | V_{ISO} | 5000 | V _{RMS} |
| Insulation resistance | $V_{IO} = 500\text{ V}$ | R_{IO} | 10^{12} | Ω |
| | $V_{IO} = 500\text{ V}, T_{amb} = 100\text{ }^{\circ}\text{C}$ | R_{IO} | 10^{11} | Ω |
| | $V_{IO} = 500\text{ V}, T_{amb} = 150\text{ }^{\circ}\text{C}$ (construction test only) | R_{IO} | 10^9 | Ω |
| Forward current | | I_{si} | 130 | mA |
| Power dissipation | | P_{so} | 265 | mW |
| Rated impulse voltage | | V_{IOTM} | 8 | kV |
| Safety temperature | | T_{si} | 150 | $^{\circ}\text{C}$ |
| Comparative tracking index | | CTI | 175 | |
| Clearance distance | | | 8.0 | mm |
| Creepage distance | | | 8.0 | mm |
| Insulation distance (internal) | | | 0.40 | mm |

Note

- According to DIN EN 60747-5-2 (VDE 0884) (see figure 2). This optocoupler is suitable for safe electrical isolation only within the safety ratings. Compliance with the safety ratings shall be ensured by means of suitable protective circuits.

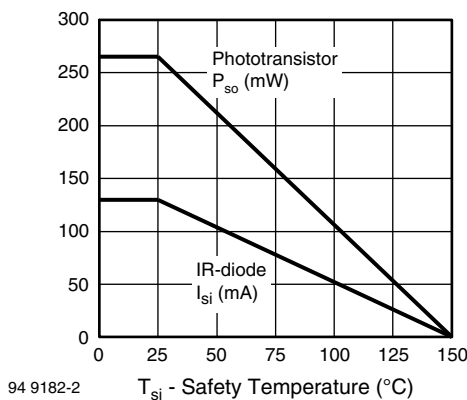

Fig. 1 - Derating Diagram



Fig. 2 - Test Pulse Diagram for Sample Test according to DIN EN 60747-5-2 (VDE 0884); IEC60747-5-5

| SWITCHING CHARACTERISTICS ($T_{amb} = 25\text{ }^{\circ}\text{C}$, unless otherwise specified) | | | | | | |
|--|---|-----------|------|------|------|---------------|
| PARAMETER | TEST CONDITION | SYMBOL | MIN. | TYP. | MAX. | UNIT |
| Delay time | $V_S = 5\text{ V}$, $I_C = 2\text{ mA}$, $R_L = 100\text{ }\Omega$, (see figure 3) | t_d | - | 3 | - | μs |
| Rise time | $V_S = 5\text{ V}$, $I_C = 2\text{ mA}$, $R_L = 100\text{ }\Omega$, (see figure 3) | t_r | - | 3 | - | μs |
| Fall time | $V_S = 5\text{ V}$, $I_C = 2\text{ mA}$, $R_L = 100\text{ }\Omega$, (see figure 3) | t_f | - | 4.7 | - | μs |
| Storage time | $V_S = 5\text{ V}$, $I_C = 2\text{ mA}$, $R_L = 100\text{ }\Omega$, (see figure 3) | t_s | - | 0.3 | - | μs |
| Turn-on time | $V_S = 5\text{ V}$, $I_C = 2\text{ mA}$, $R_L = 100\text{ }\Omega$, (see figure 3) | t_{on} | - | 6 | - | μs |
| Turn-off time | $V_S = 5\text{ V}$, $I_C = 2\text{ mA}$, $R_L = 100\text{ }\Omega$, (see figure 3) | t_{off} | - | 5 | - | μs |
| Turn-on time | $V_S = 5\text{ V}$, $I_F = 10\text{ mA}$, $R_L = 1\text{ k}\Omega$, (see figure 4) | t_{on} | - | 9 | - | μs |
| Turn-off time | $V_S = 5\text{ V}$, $I_F = 10\text{ mA}$, $R_L = 1\text{ k}\Omega$, (see figure 4) | t_{off} | - | 10 | - | μs |



Fig. 3 - Test Circuit, Non-Saturated Operation

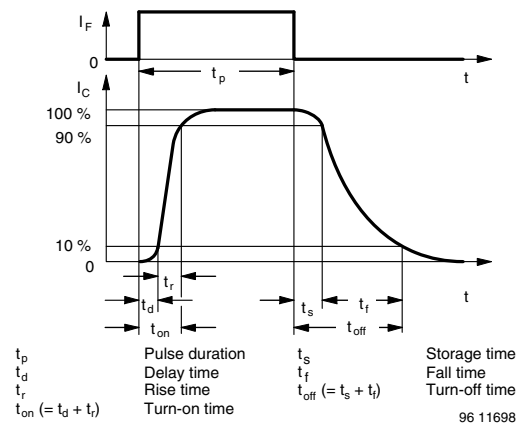

Fig. 5 - Switching Times



Fig. 4 - Test Circuit, Saturated Operation

TYPICAL CHARACTERISTICS ($T_{amb} = 25\text{ }^{\circ}\text{C}$, unless otherwise specified)

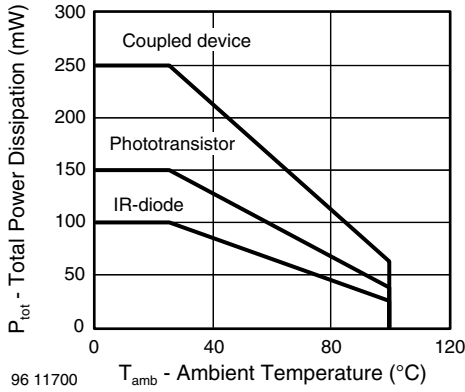

Fig. 6 - Total Power Dissipation vs. Ambient Temperature

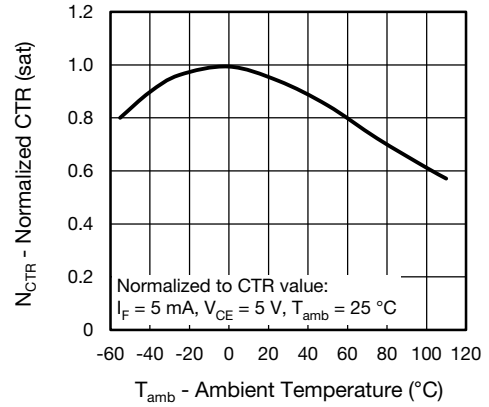

Fig. 9 - Normalized Current Transfer Ratio (saturated) vs. Ambient Temperature

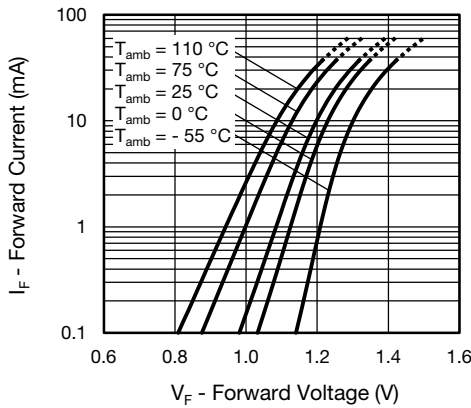

Fig. 7 - Forward Current vs. Forward Voltage

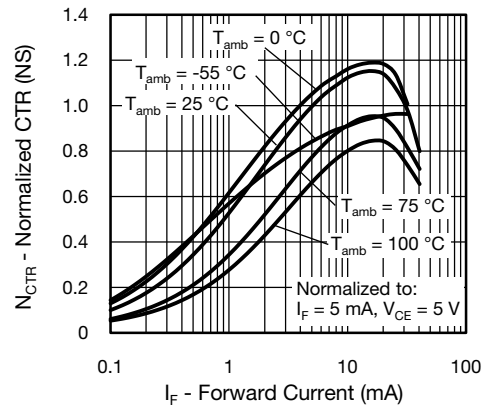

Fig. 10 - Normalized Current Transfer Ratio (non-saturated) vs. Forward Current

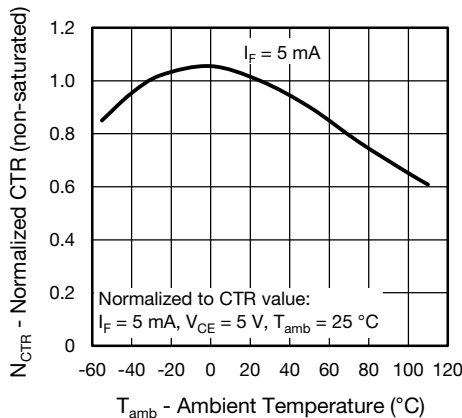

Fig. 8 - Normalized Current Transfer Ratio (non-saturated) vs. Ambient Temperature

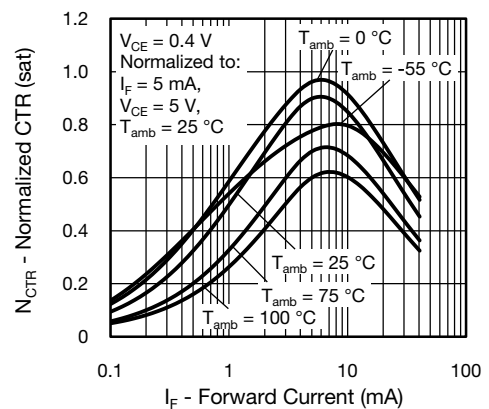

Fig. 11 - Normalized Current Transfer Ratio (saturated) vs. Forward Current



Fig. 12 - Collector Dark Current vs. Ambient Temperature



Fig. 15 - Collector Emitter Saturation Voltage vs. Collector Current



Fig. 13 - Collector Current vs. Forward Current



Fig. 16 - Current Transfer Ratio vs. Forward Current



Fig. 14 - Collector Current vs. Collector Emitter Voltage

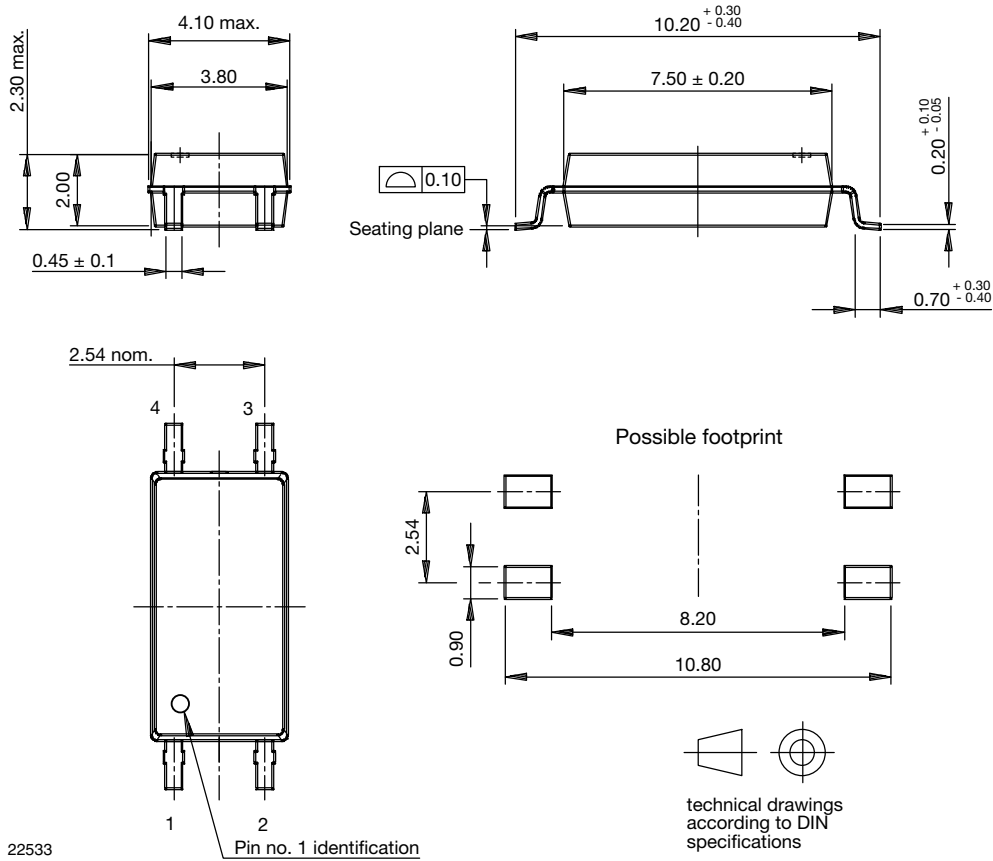

Fig. 17 - Turn-on/off Time vs. Collector Current

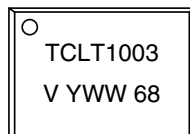

Fig. 18 - Turn-on/off Time vs. Forward Current

PACKAGE DIMENSIONS (in millimeters)



PACKAGE MARKING (example)



TAPE AND REEL DIMENSIONS (in millimeters)

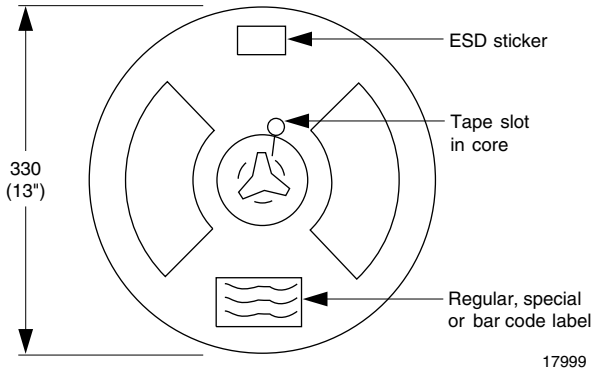

Fig. 19 - Reel Dimensions (3000 units per reel)

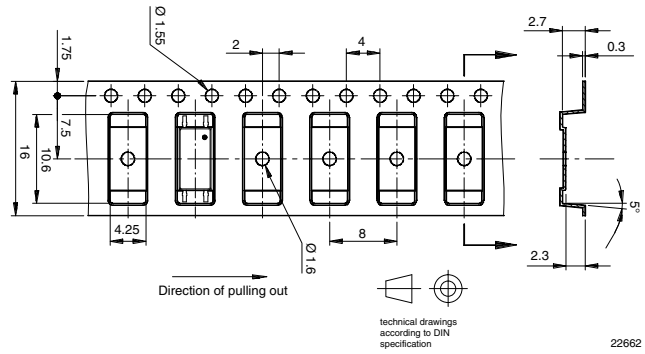

Fig. 20 - Tape Dimensions

SOLDER PROFILE



Fig. 21 - Lead (Pb)-free Reflow Solder Profile according to J-STD-020

HANDLING AND STORAGE CONDITIONS

ESD level: HBM class 2

Floor life: unlimited

Conditions: $T_{amb} < 30\text{ °C}$, RH < 85 %

Moisture sensitivity level 1, according to J-STD-020



Disclaimer

ALL PRODUCT, PRODUCT SPECIFICATIONS AND DATA ARE SUBJECT TO CHANGE WITHOUT NOTICE TO IMPROVE RELIABILITY, FUNCTION OR DESIGN OR OTHERWISE.

Vishay Intertechnology, Inc., its affiliates, agents, and employees, and all persons acting on its or their behalf (collectively, "Vishay"), disclaim any and all liability for any errors, inaccuracies or incompleteness contained in any datasheet or in any other disclosure relating to any product.

Vishay makes no warranty, representation or guarantee regarding the suitability of the products for any particular purpose or the continuing production of any product. To the maximum extent permitted by applicable law, Vishay disclaims (i) any and all liability arising out of the application or use of any product, (ii) any and all liability, including without limitation special, consequential or incidental damages, and (iii) any and all implied warranties, including warranties of fitness for particular purpose, non-infringement and merchantability.

Statements regarding the suitability of products for certain types of applications are based on Vishay's knowledge of typical requirements that are often placed on Vishay products in generic applications. Such statements are not binding statements about the suitability of products for a particular application. It is the customer's responsibility to validate that a particular product with the properties described in the product specification is suitable for use in a particular application. Parameters provided in datasheets and / or specifications may vary in different applications and performance may vary over time. All operating parameters, including typical parameters, must be validated for each customer application by the customer's technical experts. Product specifications do not expand or otherwise modify Vishay's terms and conditions of purchase, including but not limited to the warranty expressed therein.

Except as expressly indicated in writing, Vishay products are not designed for use in medical, life-saving, or life-sustaining applications or for any other application in which the failure of the Vishay product could result in personal injury or death. Customers using or selling Vishay products not expressly indicated for use in such applications do so at their own risk. Please contact authorized Vishay personnel to obtain written terms and conditions regarding products designed for such applications.

No license, express or implied, by estoppel or otherwise, to any intellectual property rights is granted by this document or by any conduct of Vishay. Product names and markings noted herein may be trademarks of their respective owners.