

PIM400 Series; ATCA Board Power Input Modules

-36 to -75 Vdc; 400W/10A

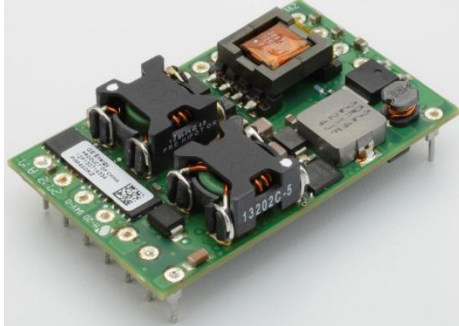

Applications

- ATCA Front Board / Blade
- Central Office Telecom equipment
- High availability server and storage applications

Options

- Choice of short pin lengths
- I²C Digital Interface

Description

The PIM400 series of Power Input Modules are designed to greatly simplify the task of implementing dual redundant, hot swap -48Vdc power distribution with EMI filtering on an ATCA or other telecom boards. The PIM400 with optional I²C digital interface capability, when used with a variety of GE's series of Bus converters (Barracuda™ Series) /POLs (DLynx™ Series) provides for a quick, simple and elegant power solution to a wide variety of demanding & intelligent power system architectures.

Features

- -48V/10A Dual redundant input power distribution
- 3.3Vdc/3.6A & 5.0Vdc/150mA of isolated Management Power for IPM or other housekeeping functions
- Independent holdup capacitor charging voltage; trimmable from 50 to 95Vdc for optimal real estate
- OR'ing functionality, Inrush protection & hot swap capability
- Integral EMI filter designed for the ATCA board to meet CISPR Class B with minimal external filtering
- Protection: Reverse polarity, under voltage, input transient over voltage/current and temperature
- I²C digital interface options
- Isolated A/B Feed Loss /Open Fuse Alarm
- High efficiency : 98%
- -40 to 85°C ambient temperature operation
- Industry Standard Quarter brick size: 58.4 mm x 36.8 mm x 13.7 mm (2.3 in x 1.45 in x 0.54 in)
- MTBF : 2,308,563 hours per TELCORDIA
- Compliant to RoHS Directive 2011/65/EU and amended Directive (EU) 2015/86 and Compliant to REACH Directive (EC) No 1907/2006
- ANSI/UL# 62368-1 and CAN/CSA[†] C22.2 No. 62368-1 Recognized, DIN VDE[‡] 0868-1/A11:2017 (EN62368-1:2014/A11:2017)
- Meets the voltage and current requirements for ETSI 300-132-2 and complies with and licensed for Basic insulation rating 2250 Vdc Isolation tested in compliance with IEEE 802.3[¶] PoE standards
- ISO**9001 and ISO 14001 certified manufacturing facilities

* UL is a registered trademark of Underwriters Laboratories, Inc.

† CSA is a registered trademark of Canadian Standards Association.

‡ VDE is a trademark of Verband Deutscher Elektrotechniker e.V.

** ISO is a registered trademark of the International Organization of Standards

¶ IEEE and 802 are registered trademarks of the Institute of Electrical and Electronics Engineers, Incorporated.

PIM400 Series; ATCA Board Power Input Modules

-36 to -75 Vdc; 400W/10A

Absolute Maximum Ratings

Stresses in excess of the absolute maximum ratings can cause permanent damage to the device. These are absolute stress ratings only, functional operation of the device is not implied at these or any other conditions in excess of those given in the operations sections of the data sheet. Exposure to absolute maximum ratings for extended periods can adversely affect the device reliability.

Parameter	Device	Symbol	Min	Typ	Max	Unit
Input Voltage						
Continuous	All	V_I	-0.5		-75	V _{dc}
Transient (Pulse duration = 1ms, square wave)	All	V_{tr}			-100	V _{dc}
Additionally: Transient Input Undervoltage, Overvoltage and Impulse per ANSI T1.315-2001(R2006)	All					
Reverse Polarity Protection					+75V	V _{dc}
Holdup Capacitor						
Voltage (with respect to -48V_OUT)	All	V_{HLDP}			100	V _{dc}
Capacitance	All	C_{HLDP}	100		3300	μF
Temperature						
Normal Operating Ambient Temperature (See Thermal Considerations section)	All	T_A	-40		85	°C
Storage Temperature	All	T_{stg}	-55		125	°C
Isolation Voltage						
Input to MGMT_PWR Output Voltage & Alarm	All				2250	Vdc
Input to SHELF_GND Voltage	All				2250	Vdc
Input to LOGIC_GND Voltage	All				2250	Vdc

CAUTION:

- This power module is not internally fused. Both A & B feeds and their corresponding returns must be individually fused.**

To preserve maximum flexibility, internal fusing is not included. However, to achieve maximum safety and system protection, the safety agencies require a fast-acting fuse with a maximum rating of 20 Amps and Voltage Rating $\geq 75Vdc$ for the -48AF, -48BF VRTN_AF & VRTN_BF feeds. Consult Fusing and fault protection Section of PICMG 3.0 ATCA specifications for additional information. Based on the information provided in this data sheet on inrush current and maximum dc input current, the same type of fuse with a lower rating can be used. Refer to the fuse manufacturer's data sheet for further information.

PIM400 Series; ATCA Board Power Input Modules

-36 to -75 Vdc; 400W/10A

ATCA Board Typical Application

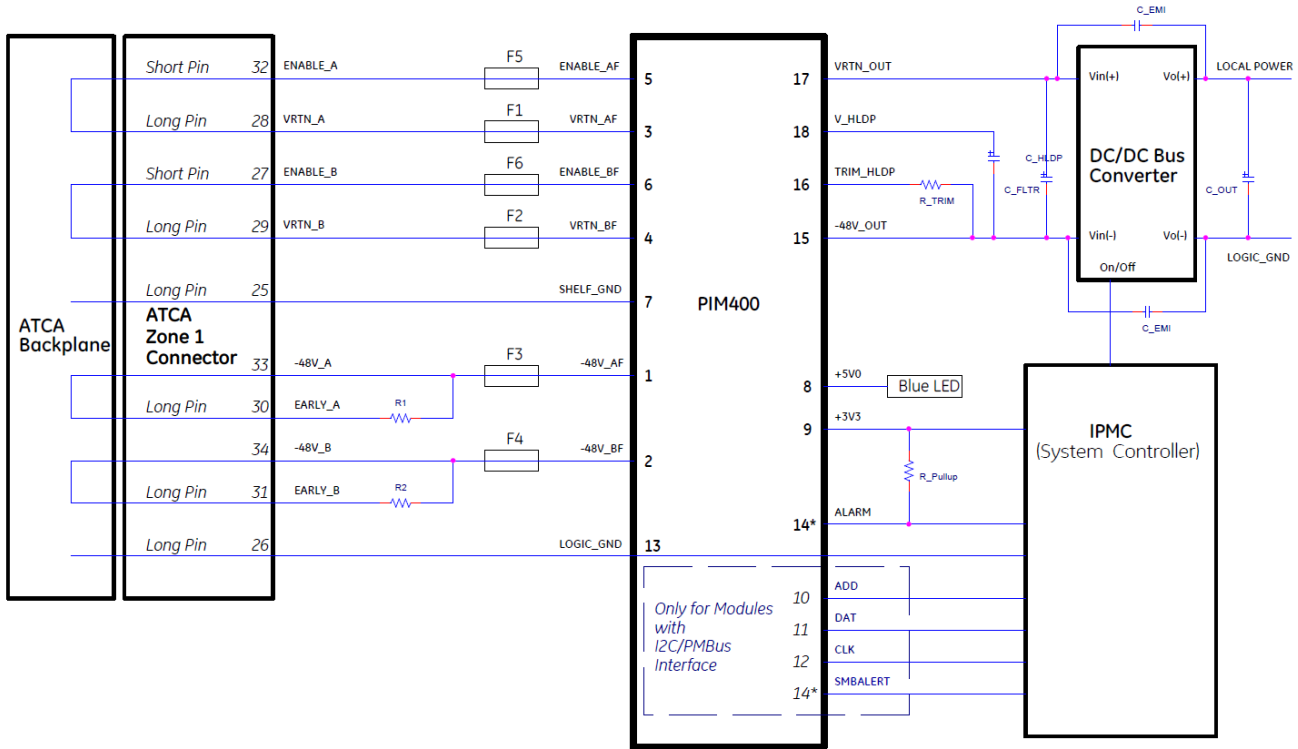

External Holdup Capacitor Selection	External Holdup Trim Resistor Selection
$C_{HLDP} = \frac{2T_{HU}P_{HU}}{V_{HLDP}^2 - V_{UV}^2}$	$R_{TRIM}(\Omega) = \left(\frac{500,000}{V_{HLDP} - 50.0} - 10,000 \right)$

Suggested Bill of Materials

(Note: Customer is ultimately responsible for the final selection and verification of the suggested parts for the end application).

Ref Des	Description (Values)	Comments
F1-F4	Fuses (15A)	Max fuse rating not to exceed 20A, fast acting
F5,F6	Fuses (15A)	0.5 to 1A rated
R1,R2	Pre-charge Resistors (15 Ohms)	High Surge Power Type e.g. KOA P/N SG73
R_TRIM	Resistor	See Design Consideration section for details
R_PULLUP	Resistor (3.3 kOhms)	Alarm pull-up resistor
C_FLTR	Capacitor(s) (100µF)	300 µF (max)
C_HLDP	Capacitor(s)	3300µF (max); see Design Consideration section for details
C_OUT	Capacitor(s)	Consult data sheet for the applicable DC/DC Bus Converter
C_EMI	Capacitors	See Design Consideration section for details

PIM400 Series; ATCA Board Power Input Modules

-36 to -75 Vdc; 400W/10A

Electrical Specifications

Unless otherwise indicated, specifications apply over all operating input voltage, resistive load, and temperature conditions.

Parameter	Device	Symbol	Min	Typ	Max	Unit	
-48V Dual Feed Inputs (-48_AF,-48_BF,VRTN_AF,VRTN_BF)							
Input Voltage Range	All	V_i	-36	-48	-75	Vdc	
Output Current With the following maximum power limits 400W @ 40V _{in} , 480W @ 48V _{in} , 540W @ 54V _{in}	All	I_o			10	Adc	
Disabled input current drain if input voltage falls below V_{UVLO} for > 2 seconds.	All	I_{UVLO}		10		mA	
Enabled No-load input current	All	I_{stdby}		40	70	mA	
Inrush Transient (@ -48 V _i , C_FLTR = 200 μ F & EARLY_A, EARLY_B Pre-charge resistors 15 ohms per leg as recommended in the " ATCA Board Typical Application" figure, p=2) Duration: 0.1ms to 0.9ms Duration: 0.9ms to 3 ms (Logarithmically declining)	All	I_{pk} I_{pk}			40 40 to 18	Adc Adc	
ENABLE A/B Signal Inputs (ENABLE_A, ENABLE_B)							
Input Voltage Threshold (On/Off); Default Setting	All	V_{UVHI} (On)	-33.5	-35.3	-36.0	Vdc	
		V_{UVLO} (Off)	-32.4	-33.7	-34.1		
Enable A / B Signals current drain (Vin = -48Vdc)	All			380		μ Adc	
Main Output (-48V_OUT, VRTN_OUT)							
Efficiency (Vin=-48V; 3,3V/5.0V @ no load)							
400W Output Power	All	η		98.2		%	
300W Output Power	All	η		98.5		%	
Output Voltage Delay	All	T_{delay}		100		ms	
Input Current Limit	All	I_{limit}	11	13	15	A	
External Output Filter Capacitance (C_FLTR)	All	C_FLTR	80	100	300	μ F	
Holdup Capacitor Output Voltage (V_HLDP)							
Holdup Capacitor Voltage Trim Range	All	V_{HLDP}	50	90	95	V	
Holdup Capacitor Output Voltage Tolerance @ V_{HLDP} =90Vdc			+6		-6	%	
-48V_OUT Threshold							
To charge external holdup capacitors (C_HLDP)					40.0		
To discharge external holdup capacitors (C_HLDP)				-34.5	-36.0	-37.5	
dV/dt on Hold-up Connect					80		V/ms
Switching Frequency		f		330		kHz	
A/B Feed Loss / Fuse Alarm Output (ALARM)							
ALARM ON Input Voltage Threshold	All		-36.4	-37.2	-40.4	Vdc	
ALARM OFF Input Voltage Threshold				-40.5		Vdc	
External Pull-up Voltage					5.0	Vdc	

PIM400 Series; ATCA Board Power Input Modules

-36 to -75 Vdc; 400W/10A

Electrical Specifications (continued)

Parameter	Output Voltage	Symbol	Min	Typ	Max	Unit
+3.3V Isolated Management Power Output (+3V3)						
Input Under-Voltage Lockout	All		-32.4	-33.7	-34.1	V
Turn-On Voltage Threshold				-34.5		V
Total Output Voltage Range (Over all operating input voltage, resistive Load and temperature conditions until end of life).	All	+3V3	3.170	3.350	3.430	V
Output Current	All	I_o	0	—	3.6	Adc
Output Ripple and Noise Measured across 10 μ F ceramic capacitor $V_I = V_{I,nom}$, $T_A = 25^\circ\text{C}$, $I_o = I_{o,max}$ RMS (500 MHz bandwidth)	All		—	16	50	mV _{rms}
Peak-to-peak (500MHz bandwidth)			—	75	200	mV _{p-p}
Output Current- Limit Inception	All	$I_{o,lim}$	—	4	6	A _{rms}
Output Short-circuit Current	All	$I_{o,sc}$	—	3	—	A _{rms}
External Load Capacitance	All	$C_{O,max}$	0	—	1000	μ F
Switching Frequency	All	f		330		kHz
Dynamic Response ($di/dt = 0.1\text{A}/\mu\text{s}$, $V_{in} = V_{in,nom}$, $T_A = 25^\circ\text{C}$) Load change from $I_o = 50\%$ to 75% of $I_{o,max}$,	All					
Peak Deviation		V_{pk}		7		%, $V_{O,set}$
Settling Time ($V_o < 10\%$ of peak deviation)		t_s		800		μs
Turn-On Delay ($I_o = 80\%$ of $I_{o,max}$, $T_A = 25^\circ\text{C}$)	All	T_{delay}		50		ms
Output voltage overshoot ($I_o = 80\%$ of $I_{o,max}$, $V_I = 48\text{Vdc}$, $T_A = 25^\circ\text{C}$)	All				3%	%, $V_{O,set}$
Output Over Voltage Protection	All	$V_{o,limit}$	3.7		5.4	V
+5.0V Isolated Management Power Output (+5V0)						
Total Output Voltage Range (Over all operating input voltage, resistive Load and temperature conditions until end of life).	All	+5V0	4.80	5.00	5.20	V
Output Current	All	I_o	0	—	150	mAdc
Output Current-Limit Inception	All	$I_{o,lim}$	—	250	—	mA
Output Short-circuit Current	All	$I_{o,sc}$	—	150	—	mA _{RMS}
External Load Capacitance	All	$C_{O,max}$	0	—	1000	μ F
Switching Frequency	All	f	—	330	—	kHz

PIM400 Series; ATCA Board Power Input Modules

-36 to -75 Vdc; 400W/10A

Digital Interface Specifications

Unless otherwise indicated, specifications apply over all operating input voltage, resistive load, and temperature conditions. See Feature Descriptions for additional information.

Parameter	Conditions	Symbol	Min	Typ	Max	Unit
Digital Signal Interface Characteristics						
Clock frequency range		f_{CLK}		100	400	kHz
Measurement Tolerance						
Feed Voltage A/B (-48V_AF & -48V_BF)				+/-3		%
Holdup Voltage (V_HLDP)				+/-3		%
-48V_OUT current (-48V_IOUT)	% of $I_{O,max}$			+/-3		%
Module Temperature (TEMP)				+/-3		°C

General Specifications

Parameter	Device	Min	Typ	Max	Unit
Calculated MTBF ($P_O=0.8P_{O,RATED}$, 48V _{IN} , T _A =40°C, Airflow=300LFM) Telecordia Issue 2 Method 1 Case 3	All		2,308,563		Hours
Weight		—	28.3 (1.0)	—	g (oz.)

PIM400 Series; ATCA Board Power Input Modules

-36 to -75 Vdc; 400W/10A

Characteristic Curves

The following figures provide typical characteristics for the PIM400X modules at 25°C.

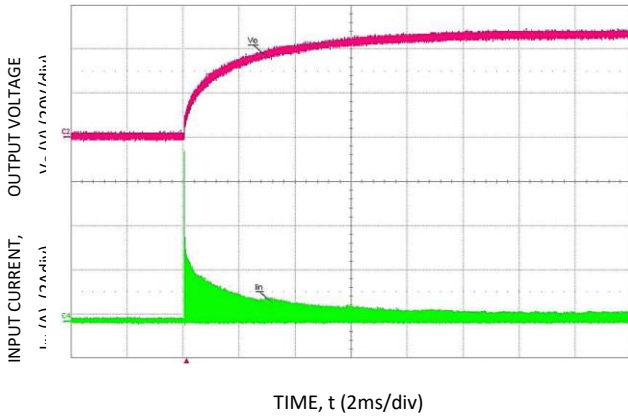

Figure 1. Inrush Current
 CH2: VRTN_OUT wrt -48Vout (Vo)
 CH4: Input current (I_{in})

Test Conditions:
 48V_{in}, 400W, C_{FLTR} = 100uF

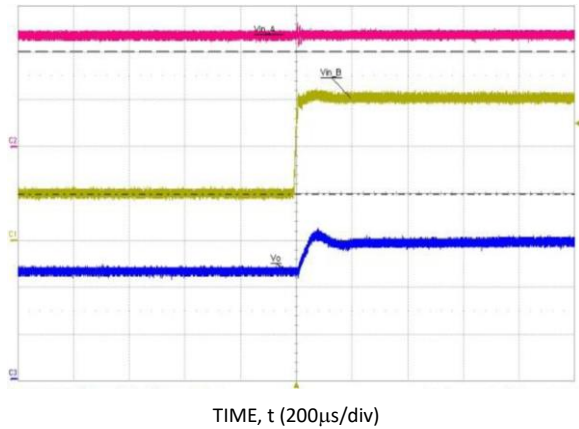

Fig 2: Input Transient on one feed
 CH1: Feed B step to 60V (20V/Div)
 CH2: Feed A at 48V (20V/Div)
 CH3: VRTN_OUT (20V/Div)
Test Conditions:
 Full load

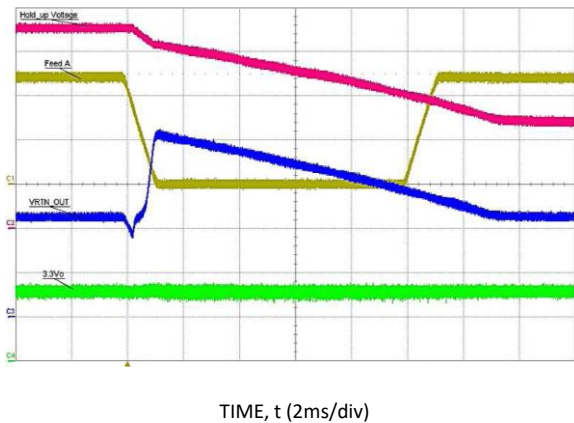

Fig 3: Hold-up Event vs 3.3Vout
 CH1: Feed A (20V/Div)
 CH2: Hold-up Voltage (20V/Div)
 CH3: VRTN_OUT (20V/Div)
 CH4: 3.3Vout (2V/Div)

Test Conditions:

1. Payload Bus Converter: QBVW033A0B
2. Load: 12.0V Bus Converter Output @ 33A; 3.3V@3.6A
3. C_{Hold-up} = 2200 µF
4. C_{FLTR}=220µF
5. V_{HLDP}=90V

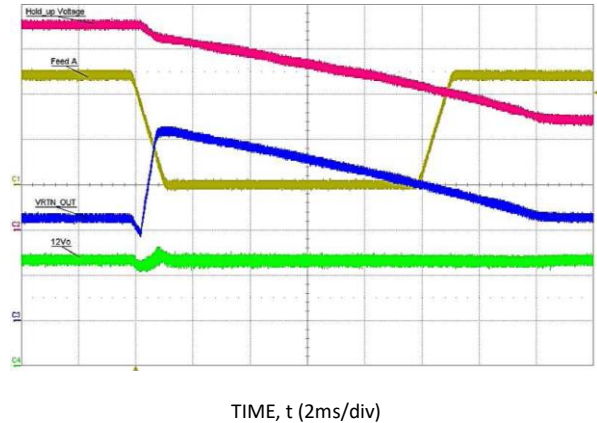

Fig 4: Hold-up Event vs 12.0Vout
 CH1: Feed A (20V/Div)
 CH2: Hold-up Voltage (20V/Div)
 CH3: VRTN_OUT (20V/Div)
 CH4: 12.0 Vout (5V/Div)

Test Conditions:

1. Payload Bus Converter: QBVW033A0B
2. Load: 12.0V Bus Converter Output @ 33A; 3.3V@3.6A
3. C_{Hold-up} = 2200 µF
4. C_{FLTR}=220µF
5. V_{HLDP}=90V

PIM400 Series; ATCA Board Power Input Modules

-36 to -75 Vdc; 400W/10A

Characteristic Curves (continued)

The following figures provide typical characteristics for the PIM400X modules at 25°C.

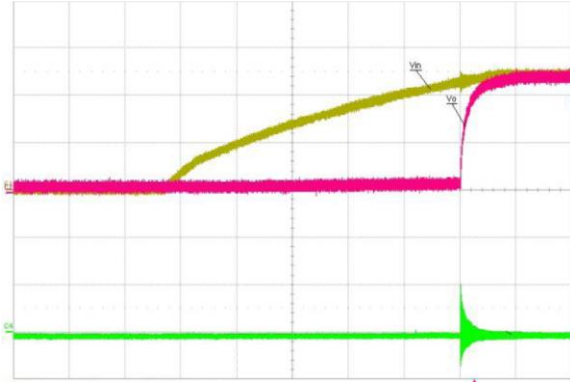

TIME, t (20ms/div)

Fig 5: Turn-ON Threshold

CH1: Input Voltage (20V/Div)
 CH2: VRTN_OUT voltage (20V/Div)
 CH4: Input Current (5A/Div)

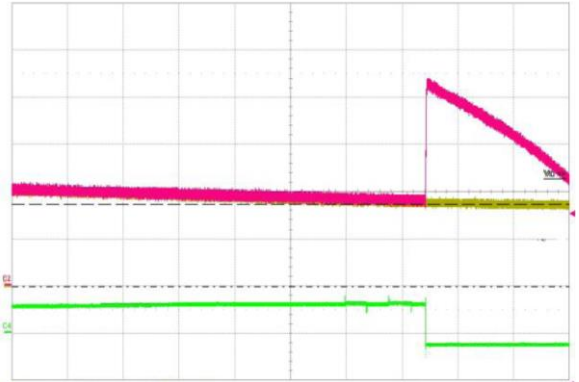

TIME, t (10ms/div)

Fig 6: Turn-OFF Threshold

CH1: Input Voltage (20V/Div)
 CH2: VRTN_OUT voltage (20V/Div)
 CH4: Input Current (2A/Div)

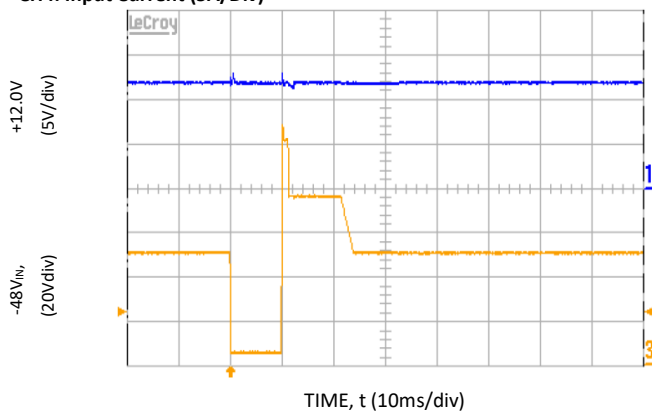

TIME, t (10ms/div)

Fig 7a: Line Transient performance per ANSI T1.315-2001 standard vs +12.0V output

CH1: +12V output voltage (5V/Div)
 CH3: -48V input Voltage (20V/Div)

Test Conditions:

1. PIM400 + QBDW033A0 (12V Bus Converter)
2. Load: +12Vout @ 30A; 3.3V @ 3.0A
3. C_HLDP = 2200 μ F
4. C_FLTR = 220 μ F

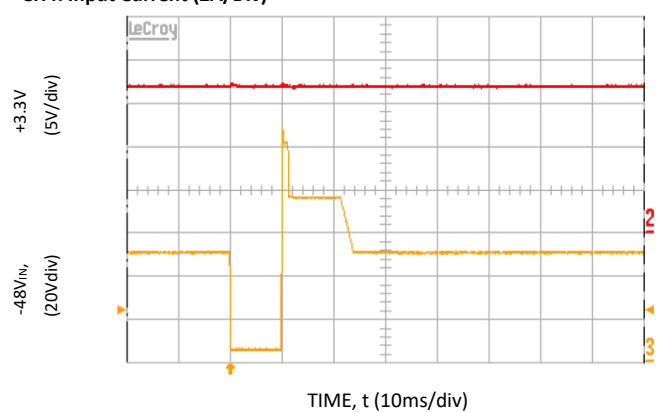

TIME, t (10ms/div)

Fig 7b: Line Transient performance per ANSI T1.315-2001 standard vs 3.3V output

CH2: +3V3 Output Voltage (1V/Div)
 CH3: -48V input Voltage (20V/Div)

Test Conditions:

5. PIM400 + QBDW033A0 (12V Bus Converter)
6. Load: +12Vout @ 30A; 3.3V @ 3.0A
7. C_HLDP = 2200 μ F
8. C_FLTR = 220 μ F

PIM400 Series; ATCA Board Power Input Modules

-36 to -75 Vdc; 400W/10A

Characteristic Curves (continued)

The following figures provide typical characteristics for the PIM400X modules at 25°C.

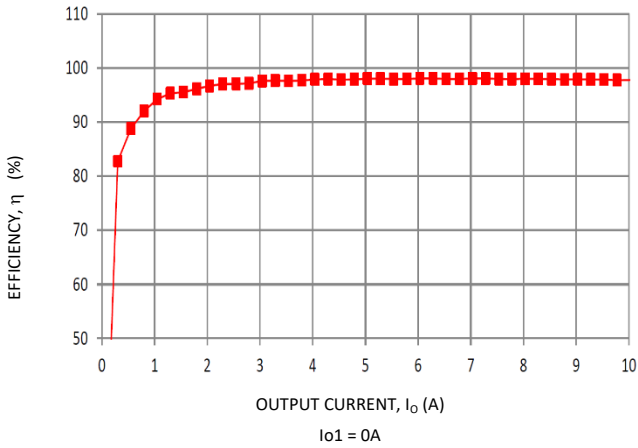

Fig 8a: Efficiency vs Output Current

Test Conditions:

No load on 3.3V output

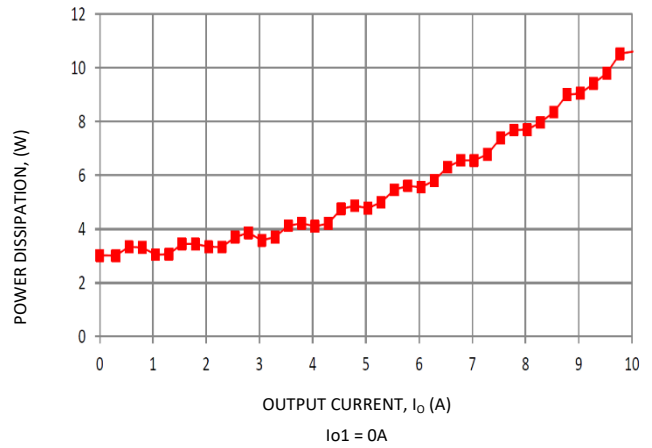

Fig 8b: Power Dissipation vs Output Current

Test Conditions:

No load on 3.3V output

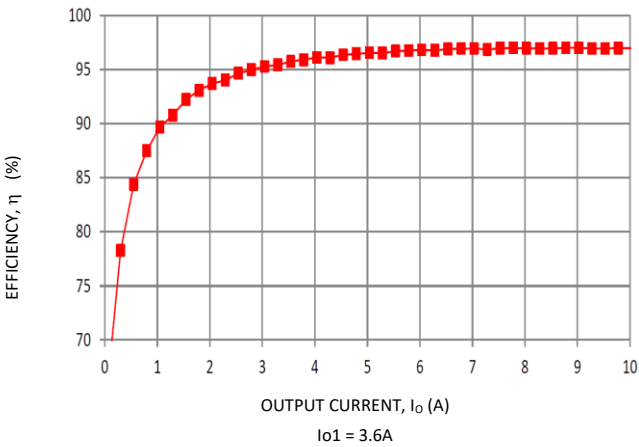

Fig 9a: Efficiency

Test Conditions:

Full load on 3.3V output

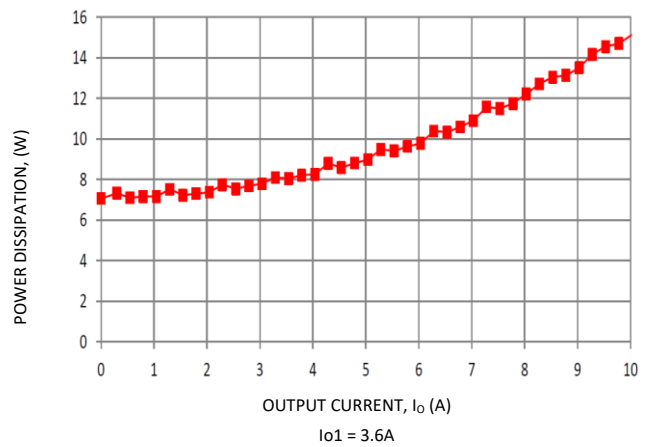

Fig 9b: Power Dissipation

Test Conditions:

Full load on 3.3V output

PIM400 Series; ATCA Board Power Input Modules

-36 to -75 Vdc; 400W/10A

Characteristic Curves (continued)

The following figures provide typical characteristics for the PIM400X modules at 25°C.

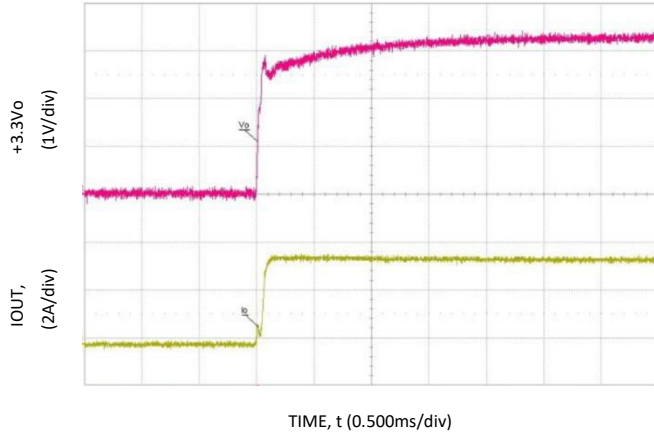

Fig 10: 3.3V Turn-On

Test Conditions:
 Cout=10µF ceramic

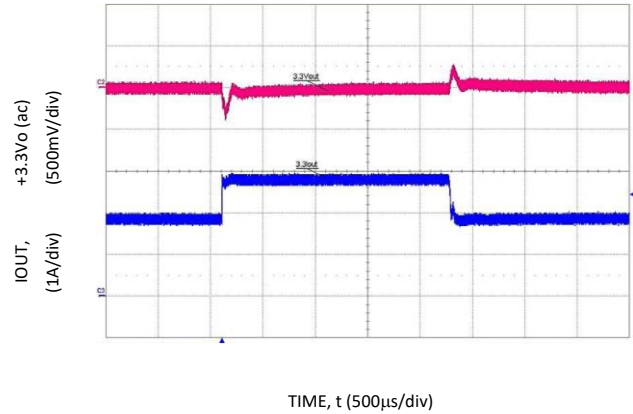

Fig 11: 3.3V Load Transient

Test Conditions:
 Cout =10µF ceramic
 Step Load Change = 50%-75%-50% of I_{out,max}
 Slew Rate = 1 A/µs

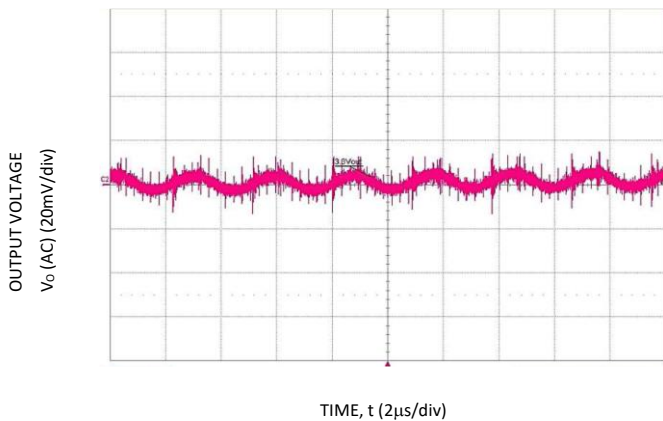

Fig 12: 3.3V Ripple

Test Conditions:
 Cout=10µF ceramic
 I_{out}=3.6A

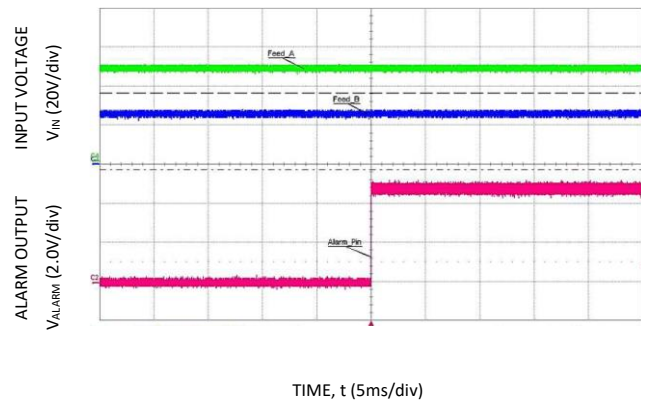
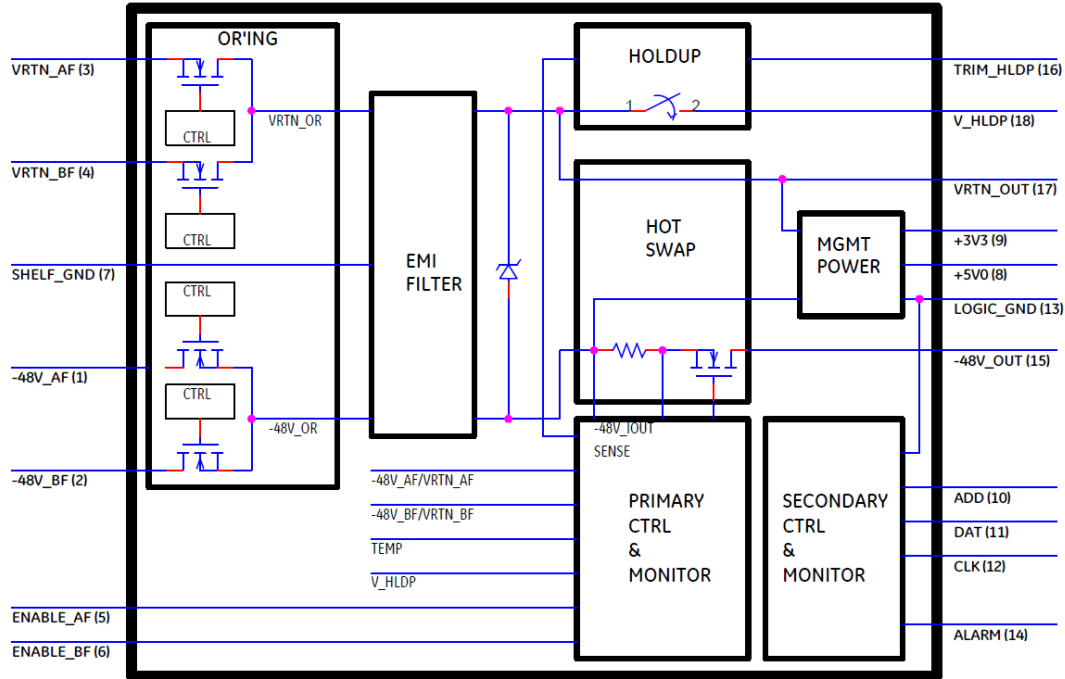

Fig 13: ALARM Output change of state with input voltage dropout

PIM400 Series; ATCA Board Power Input Modules
 -36 to -75 Vdc; 400W/10A

PIM400 Internal Block Diagram



PIN FUNCTIONS

Pin No.	Signal Name	Description
1	-48V_AF	-48V_A Feed (Externally Fused)
2	-48V_BF	-48V_B Feed (Externally Fused)
3	VRTN_AF	VRTN_A Feed (Externally Fused)
4	VRTN_BF	VRTN_B Feed (Externally Fused)
5	ENABLE_AF	ENABLE_A Feed (Externally Fused) (Short Pin, connected to VRTN_A on the back plane)
6	ENABLE_BF	ENABLE_B Feed (Externally Fused) (Short Pin, connected to VRTN_B on the back plane)
7	SHELVE_GND	Shelf / Chassis / Safety Ground
8	+5V0	Isolated 5.0Vdc (Blue LED Power) w.r.t. LOGIC_GND
9	+3V3	Isolated 3.3Vdc (Management Power) w.r.t. LOGIC_GND
10**	ADD	I2C Address w.r.t. LOGIC_GND
11**	DAT	I2C Data w.r.t. LOGIC_GND
12**	CLK	I2C Clock w.r.t. LOGIC_GND
13	LOGIC_GND	Logic / Secondary / Isolated Ground
14	ALARM	Opto-isolated -48V A/B Feed Loss or Open Fuse Alarm (w.r.t LOGIC_GND)
15	-48V_OUT	OR'd and Inrush protected -48V Output Bus
16	TRIM_HLDP	Holdup capacitor output voltage trim w.r.t. -48V_OUT
17	VRTN_OUT	OR'd and Inrush protected VRTN Output Bus
18	V_HLDP	+ve terminal connection point for Holdup capacitor

** Pins 10, 11 & 12 are present only on modules with I²C digital interface option (-K)

PIM400 Series; ATCA Board Power Input Modules

-36 to -75 Vdc; 400W/10A

Feature Descriptions

Introduction

The PIM400X module is designed to support the Advanced Telecommunications Computing Architecture (ATCA) power entry distribution requirements for the Front Board / Blade per the PICMG 3.0 specifications.

The PICMG 3.0 specification defines the Mechanical, Shelf Management Interface, Power Distribution, Thermal, Data I/O and Regulatory requirements for the next generation of modular telecom architecture platform for use in Central Office telecom environments.

Input Pin Connections

The ATCA board is specified to accept up to a maximum of 400W of input power via dual, redundant -48Vdc Feeds through the Zone 1 (Power and Management) connector, designated P10.

The power connector provides board to backplane engagement via pins of varying lengths. Please consult the PICMG 3.0 specifications for details.

The following are the design considerations of the input pin connections of the PIM400X to the ATCA power connector.

From ATCA (P10 Connector)		Connection Requirement	To PIM400X	
Pin #	Pin Designation		Pin #	Signal Designation
33	-48V_A	Via Fuse(F3)	1	-48V_AF
34	-48V_B	Via Fuse(F4)	2	-48V_BF
28	VRTN_A	Via Fuse(F1)	3	VRTN_AF
29	VRTN_B	Via Fuse(F2)	4	VRTN_BF
30	EARLY_A	Via Resistor(R1) *		-48V_A
31	EARLY_B	Via Resistor(R2) *		-48V_B
32	ENABLE_A	Via Fuse(F5)	5	ENABLE_AF
27	ENABLE_B	Via Fuse(F6)	6	ENABLE_BF
25	SHELF_GND	Direct	7	SHELF_GND
26	LOGIC_GND	Direct	11	LOGIC_GND

* Pre-charge resistors

The first pins to mate in the ATCA power connector are the EARLY_A, EARLY_B, the two grounds (LOGIC_GND, SHELF_GND) and the two returns (VRTN_A, VRTN_B); followed by staggered connections of -48V_A and -48V_B power Feeds. The last pins to engage are the two short pins, ENABLE_A & ENABLE_B. The ATCA backplane connects the ENABLE_A to VRTN_A, ENABLE_B to VRTN_B, EARLY_A to -48V_A and EARLY_B to -48V_B.

EARLY_A & EARLY_B Connections: During hot insertion of the ATCA board, the Inrush Control circuit limits the surge current to the C_FLTR capacitor. However, due to the presence of a small amount of internal EMI filter capacitance (located before the Inrush Control circuit), it is recommended that Precharge

resistors, R1 & R2 (100 Ohms, with appropriate surge capability) be connected as shown in the Typical Application circuit.

Output Pin Connections (Standard Module: PIM400Z)

The output pin connections of the PIM400X to the system board are described below:

From PIM400X		To ATCA Front Board		Notes
Pin #	Pin Designation	Terminal	Component	
15	-48V_OUT	Vin(-)	DC/DC Converter	(1)
17	VRTN_OUT	Vin(+)	DC/DC Converter	
18	V_HLDP	+ve	Holdup Capacitor	(2)
16	TRIM_HLDP	RTrim	Holdup Capacitor	
8	+5V0		Management Power	(3)
9	+3V3			
14	ALARM	R _{pull-up}	IPM/System Controller	(4)

Additional Output Pin Connections (Modules with optional I²C Digital Interface: Option - K)

The following additional output pins of the PIM400KZ available for I²C Digital Interface to the IMP/System Controller are defined below:

From PIM400KZ		To ATCA Front Board		Notes
Pin #	Pin Designation	IPM/System Controller I2C Interface		
10	ADD	I2C Address w.r.t. LOGIC_GND		(5)
11	DAT	I2C Data w.r.t. LOGIC_GND		
12	CLK	I2C Clock w.r.t. LOGIC_GND		

Inrush Current Control / Hot Plug Functionality

The module provides inrush current control / hot plug capability. The peak value of the inrush current and the duration complies with the PICMG 3.0's Inrush Transient specifications. The specifications shall be met with the external C_HLDP and C_FLTR capacitances as specified in the previous sections.

The unique design of the module where the large energy storage capacitors are segregated from the input filter capacitors allows the module to meet the stringent PICMG's inrush transient specifications with minimal energy storage capacitors.

PIM400 Series; ATCA Board Power Input Modules

-36 to -75 Vdc; 400W/10A

Design Considerations

-48V Main Output Bus:

(Signal Names: -48V_OUT & VRTN_OUT)

This is the main -48V output bus that provides the payload power to the downstream (one or more) DC/DC converters. The PIM400X module does not regulate or provide isolation from the input -48V A/B feeds.

The main functionality of the module is to provide -48V A/B Feeds OR'ing, inrush protection for hot swap capability and EMI filtering to attenuate the noise generated by the downstream DC/DC converters.

- The -48V_OUT pin connects to the Vin(-) pin and the VRTN_OUT pin connects to the Vin(+) pin of the DC/DC converter(s).
- The -48V_OUT bus may require a fuse depending on the power and fusing requirements of the DC/DC converter.
- Input filtering of the DC/DC converter is provided by C_FLTR close to the input pins of the DC/DC converter(s); additional high frequency decoupling ceramic capacitors (0.01 to 0.1μF are recommended for improved EMI performance).
- The maximum C_FLTR capacitance across all the downstream DC/DC converters should not exceed 300μF.
- The minimum C_FLTR capacitance (80μF) recommendation is based on meeting the EMI requirements.

Holdup Capacitor Output Voltage (V_HLDP)

This output provides the user settable high voltage to charge the C_HLDP capacitor(s) to allow the ATCA board to meet the 5ms, 0Volts transient requirements.

- The V_HLDP pin connects to the +ve terminals of the C_HLDP capacitors while the -ve terminals of the C_HLDP connects to the -48V_OUT bus.
- The C_HLDP capacitance is dependent on the system power and the holdup time requirements based on the following formula

$$C_{HLDP} = \frac{2T_{HU}P_{HU}}{V_{HLDP}^2 - V_{UV}^2}$$

Where T_{HU} is the desired holdup time, P_{HU} is the holdup power drawn from the holdup capacitors (=input power of the downstream DC/DC bus converter + Management Power), V_{HLDP} is the trimmed holdup capacitor voltage and V_{UV} is the undervoltage lockout threshold of either the downstream bus or the Management Power DC/DC converter (higher of the two).

Holdup Capacitor Trim Voltage (TRM_HLDP)

The resistor R_{TRIM} sets the external holdup capacitor voltage to the desired setting. The output voltage is adjustable from 50 to 90V. The resistor, R_{TRIM} is selected by the following equation:

$$R_{TRIM}(\Omega) = \left(\frac{500,000}{V_{HLDP} - 50.0} - 10,000 \right)$$

High Voltage Discharge Mechanism:

Per the PICMG 3.0 specifications, the PIM400 provides an internal discharge mechanism to discharge the holdup/bulk capacitance to less than -60Vdc and less than 20 joules within one second of disconnection from the backplane.

Management Power (+3V3, +5V0)

Two isolated secondary output voltages (+3V3 & +5V0) are provided for ATCA Front Board's IPM/System Controller (3.3V) and for the Blue LED's (5.0V) power requirements. Both the outputs are referenced to LOGIC_GND.

- The management power is available even when the input voltage is down to -36Vdc.
- No additional output capacitors are required, but a 22μF tantalum/ceramic and a 0.01 to 0.1μF ceramic capacitors are highly recommended to contain the switching ripple and noise.

Input Fault Alarm Signal (ALARM)

Both the input feeds, -48V_AF & -48V_BF are monitored via the -48V_ALARM signal. In the event of a loss of power from either feeds (-48V_A or -48V_B) or the opening of their respective fuses, the -48V_ALARM shall change its logical state indicating a fault. During normal operation, the signal is Low. During fault condition, the alarm signal shall assume a HI state when the ALARM pin is pulled up to an external pull voltage (maximum 5.0V) via an external pullup resistor (R_{PULLUP}). The ALARM output is internally referenced to the LOGIC_GND. A 3.3K pull up resistor to 3.3V Management Power should suffice.

EMI Filtering

The module incorporates an EMI filter that is designed for the ATCA board to help meet the conducted emissions requirements of CISPR 22 Class B when used in conjunction with GE's DC/DC bus converters recommended for ATCA applications.

The following Figure 14 depicts the Class B EMI performance of PIM400F when tested with GE's bus converter, QBVW033A0B1 with both modules mounted on the PIM400 Evaluation Board together with additional high frequency EMI capacitors (Fig 15).

PIM400 Series; ATCA Board Power Input Modules

-36 to -75 Vdc; 400W/10A

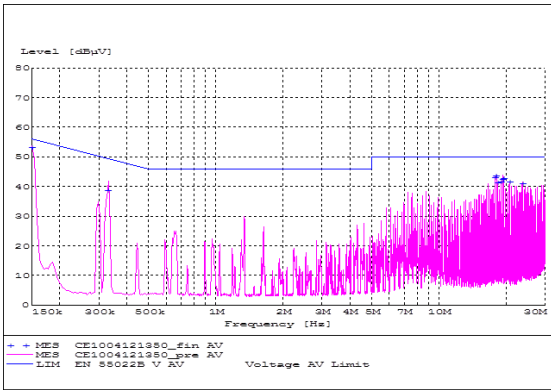

Figure 14. Typical Class B EMC signature of PIM400F as tested with GE's bus converter, QBVW033A0B1 module.

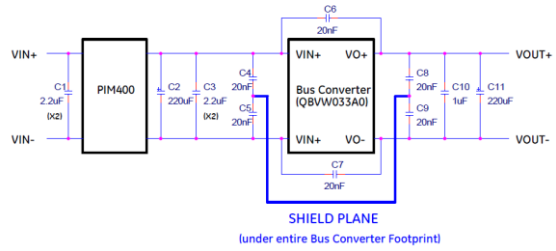

Figure 15. PIM400 & QBVW033A0 Bus Converter Test setup schematic

For Safety and noise considerations, copper traces must not be routed directly under the power module (PWB top layer). C_EMI capacitors must make direct connections (preferably without vias) to the bus converter (DC/DC) module pins with as much copper width as possible. In case vias are necessary, allow for multiple connections to the inner plane with vias placed outside the footprint of the module. For additional layout guide-lines, refer to GE's FLT012A0Z Input Filter Module data sheet.

Safety Considerations

For safety agency approval the power module must be installed in compliance with the spacing and separation requirements of the end-use safety agency standards, i.e., UL ANSI/UL* 62368-1 and CAN/CSA+ C22.2 No. 62368-1 Recognized, DIN VDE 0868-1/A11:2017 (EN62368-1:2014/A11:2017)

The power input to these units is to be provided with a maximum of fast acting 20A fuses with a voltage rating of at least 75Vdc. Refer to "Thermal Consideration" section for additional safety considerations.

Thermal Considerations

The power modules operate in a variety of thermal environments; however, sufficient cooling should be provided to help ensure reliable operation.

Considerations include ambient temperature, airflow, module power dissipation, and the need for increased reliability. A reduction in the operating temperature of the module will result in an increase in reliability. The thermal data presented here is based on physical measurements taken in a wind tunnel.

The thermal reference point, T_{ref} , used in the specifications is shown in Figure 16. For reliable operation this temperature should not exceed 130°C. In addition, the output current of the module should not exceed the rated current for the module as listed in the Ordering Information table, or the derated current for the actual operating conditions as indicated in Figs. 17 & 18.

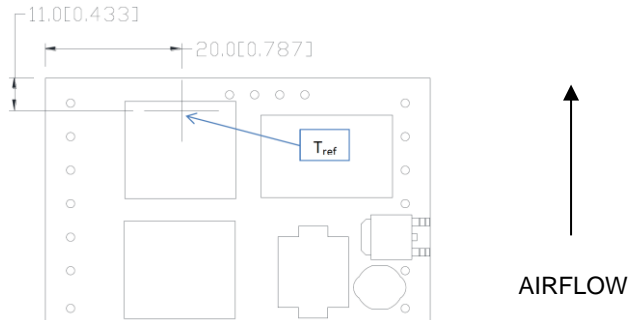

Figure 16. T_{ref} Temperature Measurement Location.

Heat Transfer via Convection

Increased airflow over the module enhances the heat transfer via convection. Derating curves showing the maximum output current that can be delivered by each module versus local ambient temperature (T_A) for natural convection and up to 2 m/s (400 lfm) forced airflow are shown in Figures 17 & 18.

Please refer to the Application Note "Thermal Characterization Process For Open-Frame Board-Mounted Power Modules" for a detailed discussion of thermal aspects including maximum device temperatures.

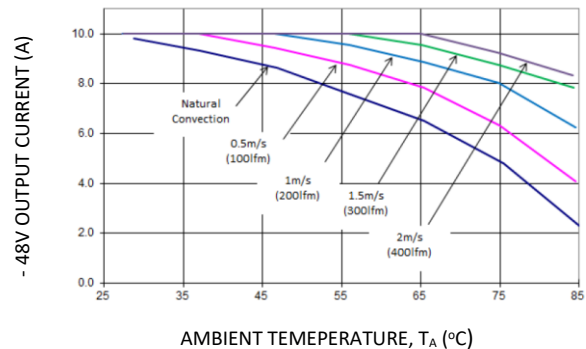

Figure 17. -48V Output Current Derating for the Module; Airflow in the Transverse Direction from Pin7 to Pin1; $V_{in} = -48V$ & $3.3V$ @ $1.5A$.

PIM400 Series; ATCA Board Power Input Modules

-36 to -75 Vdc; 400W/10A

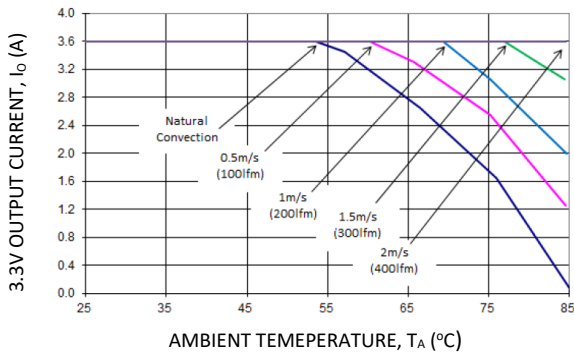

Figure 18. 3.3V Output Current Derating for the Module; Airflow in the Transverse Direction from Pin7 to Pin1; Vin =48V & -48V Output current = 4A.

Layout Considerations

The power modules are low profile in order to be used in fine pitch system card architectures. As such, component clearance between the bottom of the power module and the mounting board is limited. Avoid placing copper areas on the outer layer directly underneath the power module. Also avoid placing via interconnects underneath the power module. Particular attention should be paid to the clearance area as noted in the Bottom View of the Mechanical Outline drawing.

For additional layout guidelines, refer to FLT012A0Z Data Sheet.

Process Considerations

Through-Hole Lead-Free Soldering Information

The RoHS-compliant, Z version, through-hole products use the SAC (Sn/Ag/Cu) Pb-free solder and RoHS-compliant components. The module is designed to be processed through single or dual wave soldering machines. The pins have a RoHS-compliant, pure tin finish that is compatible with both Pb and Pb-free wave soldering processes. A maximum preheat rate of 3°C/s is suggested. The wave preheat process should be such that the temperature of the power module board is kept below 210°C. For Pb solder, the recommended pot temperature is 260°C, while the Pb-free solder pot is 270°C max.

Reflow Lead-Free Soldering Information

The RoHS-compliant through-hole products can be processed with paste-through-hole Pb or Pb-free reflow process.

Max. sustain temperature :

245°C (J-STD-020C Table 4-2: Packaging Thickness >= 2.5mm / Volume > 2000mm³),

Peak temperature over 245°C is not suggested due to the potential reliability risk of components under continuous high-temperature.

Min. sustain duration above 217°C : 90 seconds

Min. sustain duration above 180°C : 150 seconds

Max. heat up rate: 3°C/sec

Max. cool down rate: 4°C/sec

In compliance with JEDEC J-STD-020C spec for 2 times reflow requirement.

Pb-free Reflow Profile

BMP module will comply with J-STD-020 Rev. C (Moisture/Reflow Sensitivity Classification for Nonhermetic Solid State Surface Mount Devices) for both Pb-free solder profiles and MSL classification procedures. BMP will comply with JEDEC J-STD-020C specification for 2 times reflow requirement. The suggested Pb-free solder paste is Sn/Ag/Cu (SAC). The recommended linear reflow profile using Sn/Ag/Cu solder is shown in Figure 19.

MSL Rating

The modules have a MSL rating of 2a.

Storage and Handling

The recommended storage environment and handling procedures for moisture-sensitive surface mount packages is detailed in J-STD-033 Rev. A (Handling,

Packing, Shipping and Use of Moisture/Reflow Sensitive Surface Mount Devices). Moisture barrier bags (MBB) with desiccant are required for MSL ratings of 2 or greater. These sealed packages should not be broken until time of use. Once the original package is broken, the floor life of the product at conditions of ≤30°C and 60% relative humidity varies according to the MSL rating (see J-STD-033A). The shelf life for dry packed SMT packages will be a minimum of 12 months from the bag seal date, when stored at the following conditions: < 40 ° C, < 90% relative humidity.

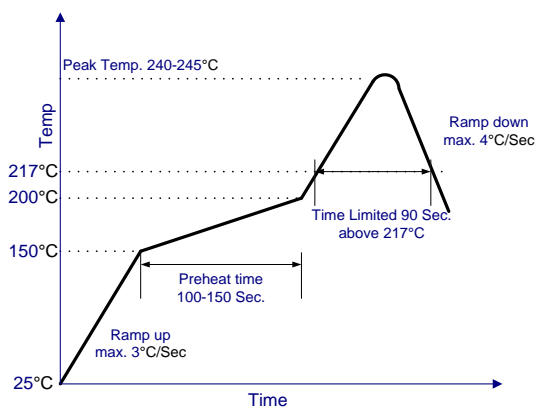

Figure 19. Recommended linear reflow profile using Sn/Ag/Cu solder.

Post Solder Cleaning and Drying Considerations

Post solder cleaning is usually the final circuit-board assembly process prior to electrical board testing. The result of inadequate cleaning and drying can affect both the reliability of a power module and the testability of the finished circuit-board assembly.

PIM400 Series; ATCA Board Power Input Modules

-36 to -75 Vdc; 400W/10A

For guidance on appropriate soldering, cleaning and drying procedures, refer to GE *Board Mounted Power Modules: Soldering and Cleaning* Application Note (AP01-056EPS).

For additional information, please contact your Sales representative for more details.

PIM400 Series; ATCA Board Power Input Modules

-36 to -75 Vdc; 400W/10A

Digital Feature Descriptions

Full featured modules are available with I²C Digital Interface (Option -K).

Modules with I²C capability monitor up to five analog parameters and six status bits identified below in Tables 1 and 2 respectively.

Modules with I²C Option Features:

Data Pointer Value	Parameter	Description	Scaling Factor
1Eh	STATUS_BITS	Digital Signals (see Table 2)	N/A
1Fh	V_HLDP	Holdup voltage w.r.t. -48V_OUT	0.398 V/bit
21h	-48V_IOUT	-48V_OUT current	0.094 A/bit
22h	-48V_AF	Voltage between -48V_AF and VRTN_AF	0.325 V/bit
23h	-48V_BF	Voltage between -48V_BF and VRTN_BF	0.325 V/bit
28h	TEMP	Module Temperature	(1.961 °C/bit) - 50°C

Table 1: Internal register memory map

Bit	Name	Description	Value	Translation
0	ENABLE_AF_STATUS	ENABLE_AF signal status	0	ENABLE_AF is Disabled
			1	ENABLE_AF is Enabled
1	ENABLE_BF_STATUS	ENABLE_BF signal status	0	ENABLE_BF is Disabled
			1	ENABLE_BF is Enabled
2	ALARM_STATUS	ALARM signal status	0	ALARM not set
			1	ALARM is set
3	N/A	Reserved		
4	HLDP_STATUS	Holdup status	0	C_HLDP not connected
			1	C_HLDP is connected
5	HOTSWAP_STATUS	Hotswap status	0	Hotswap switch is off
			1	Hotswap switch is on
6	-48VOUT_STATUS	-48V_OUT Undervoltage alarm status	0	-48V_OUT is below threshold
			1	-48V_OUT is above threshold
7	N/A	Reserved		

Table 2: Digital signals

Note: Bit 0=LSB, Bit 7=MSB

I²C Command Structure:

The I²C is a 2-wire interface supporting multiple devices and masters on a single bus. The connected devices can only pull the bus wires low and they never drive the bus high. The bus wires should be externally connected to a positive supply voltage via a pull-up resistor. When the bus is idle, both DAT and CLK are high. The max sink current supported on the I²C bus is 3.5mA.

Each device on the I²C bus is recognized by a unique address stored in that device. Devices can be classified as masters or slaves when performing data transfers. A master is a device which initiates a data transfer on the bus and generates clock signals to permit that transfer. At the same time, any device addressed is considered slave. The PIM400 always acts as a slave.

In PIM400 module, I²C interface is used for reporting critical parameters like input voltage, output current, holdup capacitor voltage and temperature data. The read protocol is shown in the Fig 20 below.

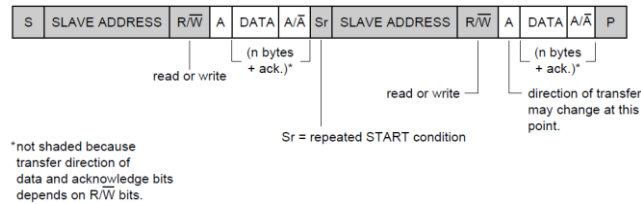

Fig 20: Typical I²C Read protocol

Address Structure:

7 bit Address + R/W bit

Four bits are fixed (0101), three bits (xyz) are variable, and the least-significant bit is the read/write bit.

8 bit Address		
0101	xyz*	R/W

Table 3: Address structure

Address Selection:

The three bits (xyz) of the address are set with a single external resistor from the ADD (pin10) to LOGIC_GND (pin 13). The 8 possible addresses are shown in Table 4 with the respective resistance values.

Address for write (R/W=0)	XYZ from Table 3	R (Ω)
5Eh	111	Open
5Ch	110	100000
5Ah	101	40200
58h	100	20000
56h	011	10000
54h	010	4020
52h	001	2000
50h	000	Short

Table 4: I²C Addressing

PIM400 Series; ATCA Board Power Input Modules

-36 to -75 Vdc; 400W/10A

Mechanical Outline

Dimensions are in millimeters and (inches).

Tolerances: x.x mm ± 0.5 mm (x.xx in. ± 0.02 in.) [unless otherwise indicated]

x.xx mm ± 0.25 mm (x.xxx in ± 0.010 in.)

Top View

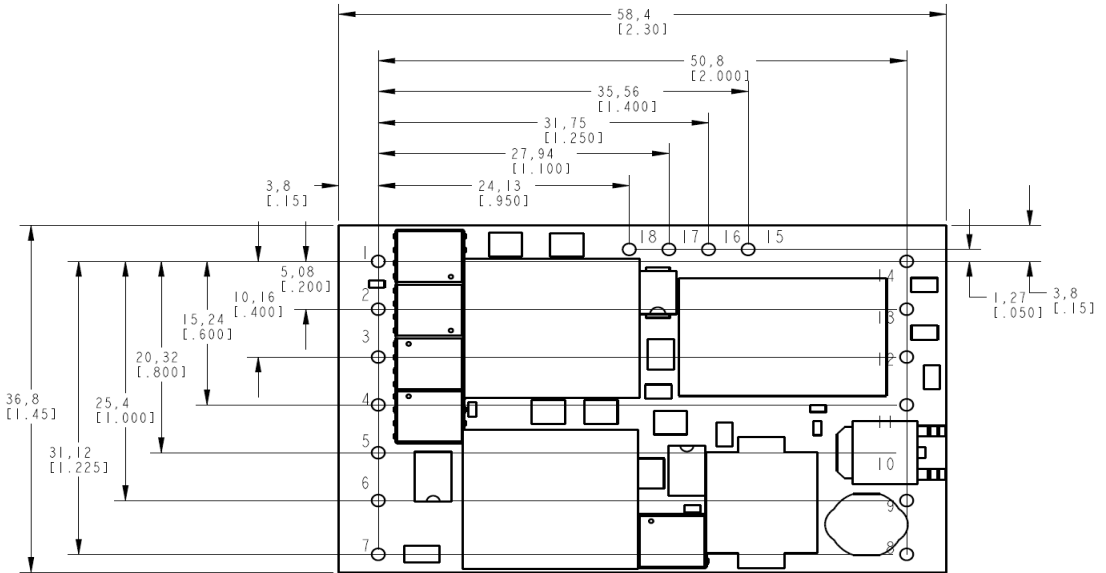

Side View

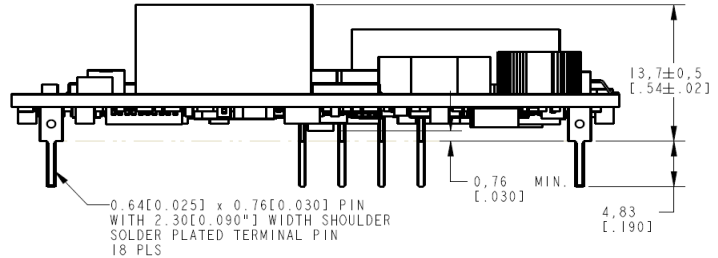

Bottom View

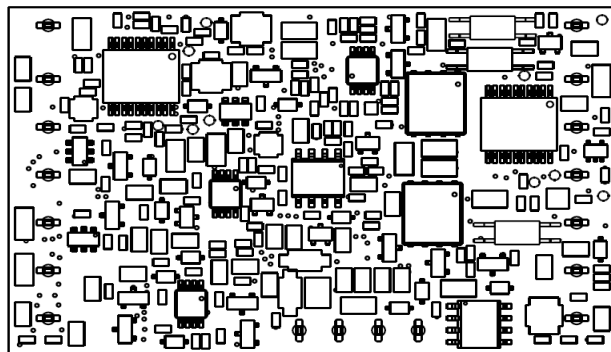

PIM400 Series; ATCA Board Power Input Modules

-36 to -75 Vdc; 400W/10A

Recommended Pad Layout

Dimensions are in millimeters and (inches).

Tolerances: x.x mm ± 0.5 mm (x.xx in. ± 0.02 in.) [unless otherwise indicated]

x.xx mm ± 0.25 mm (x.xxx in ± 0.010 in.)

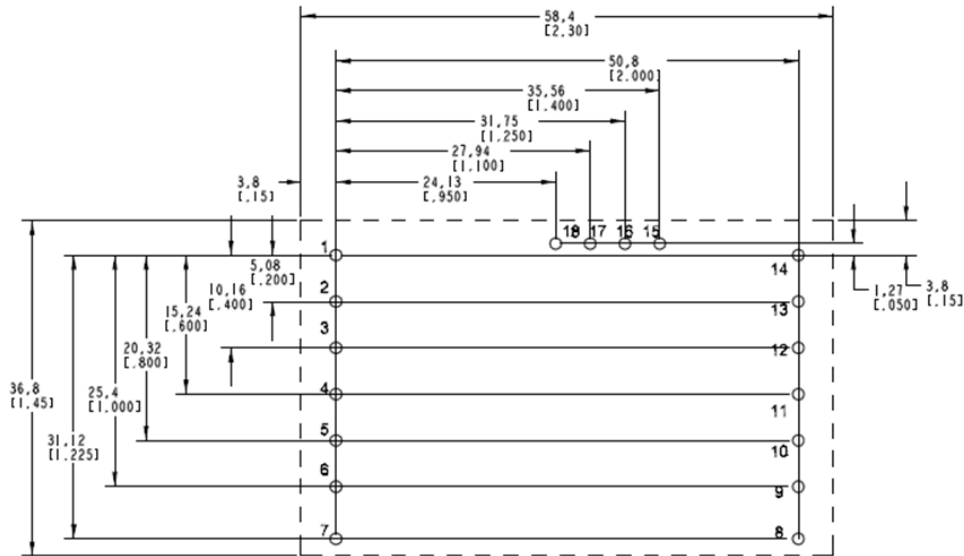

NOTES:

- FOR 0.030" X 0.025" RECTANGULAR PIN, USE 0.050" PLATED THROUGH HOLE

Pin No.	Signal Name	Pin No.	Signal Name
1	-48V_AF	10**	ADD
2	-48V_BF	11**	DAT
3	VRTN_AF	12**	CLK
4	VRTN_BF	13	LOGIC_GND
5	ENABLE_AF	14	ALARM
6	ENABLE_BF	15	-48V_OUT
7	SHELF_GND	16	TRIM_HLDP
8	+5V0	17	VRTN_OUT
9	+3V3	18	V_HLDP

** Pins 10, 11 & 12 are present only on modules with I²C digital interface option (-K).

PIM400 Series; ATCA Board Power Input Modules

-36 to -75 Vdc; 400W/10A

Packaging Details

The modules are supplied as standard in the plastic trays shown in Figure below.

Tray Specification

Material	Antistatic coated PVC
Max surface resistivity	$10^{12}\Omega/\text{sq}$
Color	Clear
Capacity	12 power modules
Min order quantity	24 pcs (1 box of 2 full trays + 1 empty top tray)

Each tray contains a total of 12 power modules. The trays are self-stacking and each shipping box for the modules will contain 2 full trays plus 1 empty hold down tray giving a total number of 24 power modules.

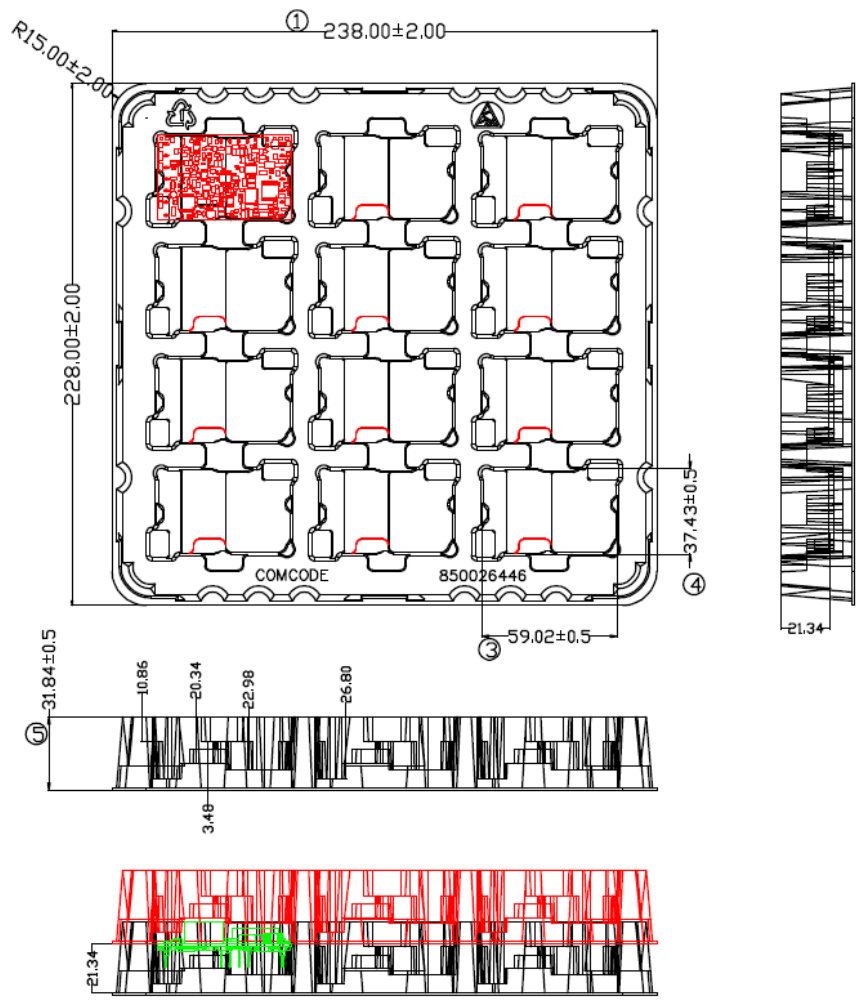

Notes:

1. All radius unspecified are R2.0mm
2. All angle unspecified are 5°
3. Dimension unit: mm(L); A°(A).

PIM400 Series; ATCA Board Power Input Modules
-36 to -75 Vdc; 400W/10A

Ordering Information

Please contact GE’s Sales Representative for pricing, availability and optional features.

Table 1. Device Code

Input Voltage	Current Rating	Auxiliary Output #1	Auxiliary Output #2	Options	Product codes	Comcodes
-36 to -75 Vdc	10A	3.3V/3.6A	5.0V/0.15A	-	PIM400Z	150019196
-36 to -75 Vdc	10A	3.3V/3.6A	5.0V/0.15A	I ² C Digital Interface	PIM400KZ	150019197
-36 to -75 Vdc	10A	3.3V/3.6A	5.0V/0.15A	I ² C Digital Interface & Short pins (3.68mm)	PIM400K6Z	150033384

Table 2. Device Options

Option	Device Code Suffix
Short pins: 3.68mm ± 0.25mm (0.145 in. ± 0.010 in.)	6
Short pins: 2.79mm ± 0.25mm (0.110 in. ± 0.010 in.)	8
I ² C Digital Interface	K

Table 3. Related Products

Description	Product Code	Comcode
PIM400 Evaluation Board	EVAL_PIM400	150030502
QBDW033A0B Series Power Modules; DC-DC Converters 36-75V _{dc} Input; 8.1-13.2V _{dc} Output; 33A Output Current	QBDW033A0B41Z	CC109159307
QBVW033A0B Series Power Modules; DC-DC Converters 36-75V _{dc} Input; 8.1-13.2V _{dc} Output; 33A Output Current	QBVW033A0B41Z	CC109165247

Contact Us

For more information, call us at

USA/Canada:

+1 877 546 3243, or +1 972 244 9288

Asia-Pacific:

+86-21-53899666

Europe, Middle-East and Africa:

+49.89.878067-280

Go.ABB/Industrial



GE Critical Power reserves the right to make changes to the product(s) or information contained herein without notice, and no liability is assumed as a result of their use or application. No rights under any patent accompany the sale of any such product(s) or information.

Mouser Electronics

Authorized Distributor

Click to View Pricing, Inventory, Delivery & Lifecycle Information:

[ABB:](#)

[PIM400KZ](#) [PIM400K8Z](#) [PIM400K6Z](#)