

D-3000 Series (Continued)

D-3200S
(High-Voltage Version of Standard D-3100S)

Appearance Board mounting pitch: Horizontal Type 200 mills (5.08 mm)
Dielectric Withstanding Voltage: 2,200 V (for one minute)
Voltage Rating: 600 V (per connector)

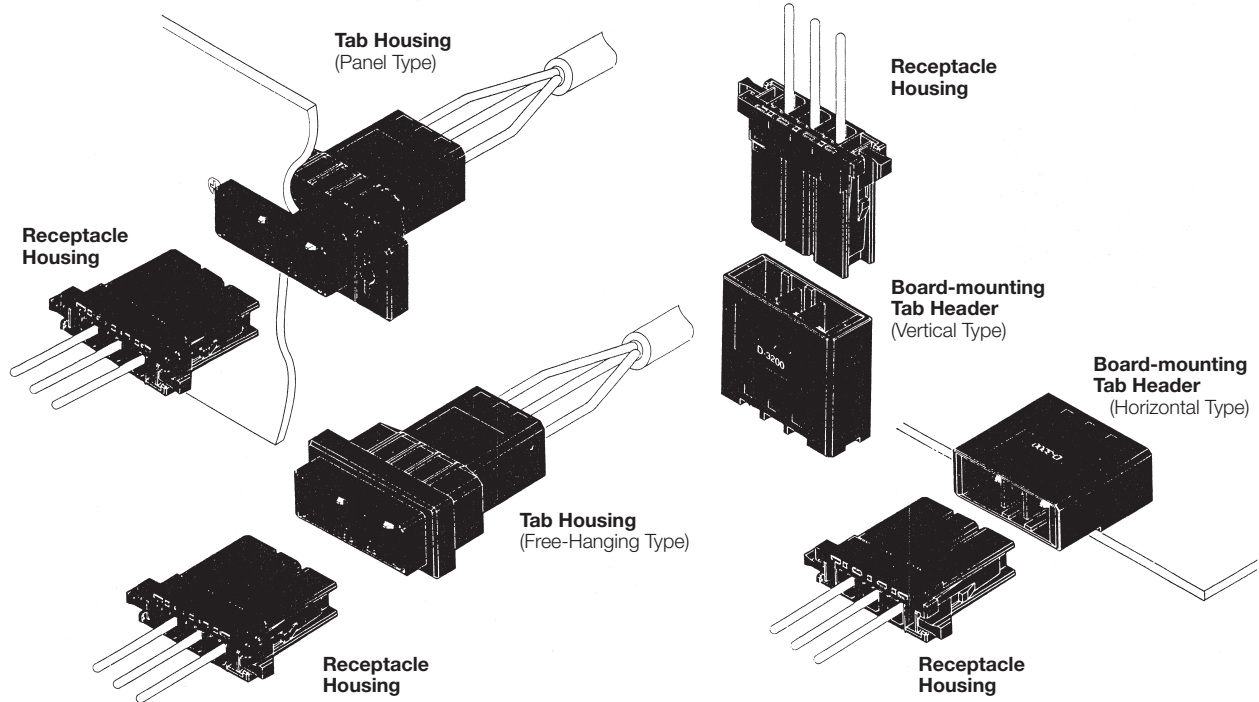

D-3000 Series

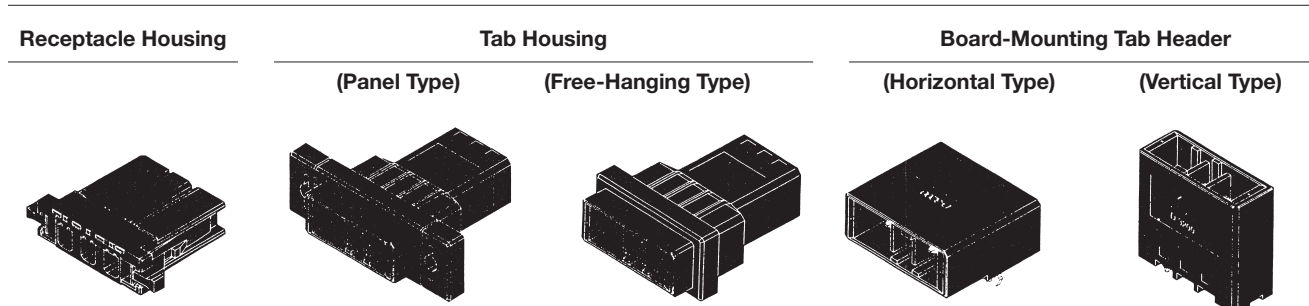

Part Number Chart

No. of Pos.	Keying	Receptacle Housing	Tab Housing			Board-mounting Tab Header	
			Panel Type	Free-Hanging Type	L Fitting	Horizontal Type	Vertical Type
2	X	1-178128-2	1-179553-2	1-179552-2	S	1-179276-□	1-917337-□
	Y	2-178128-2	2-179553-2	2-179552-2	S	2-179276-□	2-917337-□
3	X	1-178128-3*1	1-179553-3	1-179552-3	S	1-178138-□	1-178136-□
	Y	2-178128-3*1	2-179553-3	2-179552-3	S	2-178138-□	2-178136-□
	Z	3-178128-3*1	—	—	S	—	3-178136-5**
4	X	1-178128-4	1-179553-4	1-179552-4	S	1-179277-□	1-917338-□
	Y	2-178128-4	2-179553-4	2-179552-4	S	2-179277-□	2-917338-□
5	X	1-178128-5*1	Use 2-row 6 position D-3200M, in place 5 and 6 position Panel and Free-hanging Types.			1-316130-□	1-316132-□
	Y	2-178128-5*1				2-316130-□	2-316132-□
6	X	1-178128-6*1				1-316131-□	1-316133-□
	Y	2-178128-6*1				2-316131-□	2-316133-□

Note: Enter the following plating codes in -□ after Part Numbers:
-2 = 0.38µm thick gold plating, -3 = 0.76µm thick gold plating,
-5 = Tin plating

*1 can also be used in modular configuration with D-3200M Tab Housing and Tab Header.
** Tin plating Only.

D-3000 Series (Continued)

D-3200S
(High-Voltage Version of
Standard D-3100S) (Continued)

Keying

This product (D-3200S) is provided with keying to help prevent mismatching of the connector halves. Keying is available in two types – X Type and Y Type . (Shown below is the mating surface of Tab Header.)

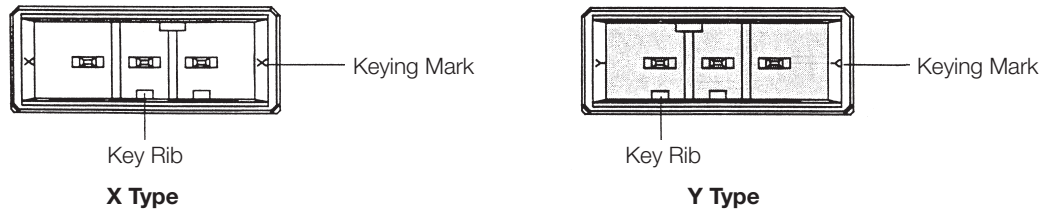

D-3000 Series

Applications

Switching regulator-Typical Applications

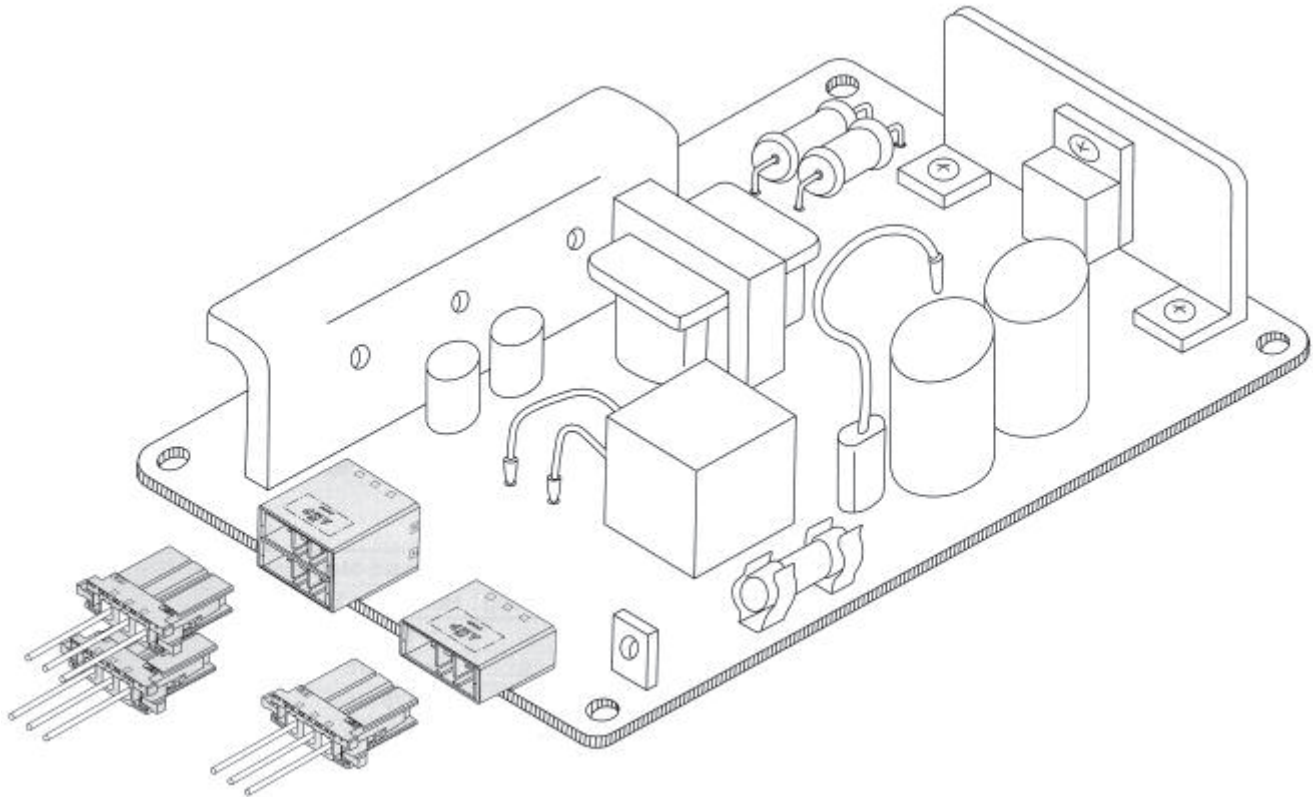

D-3000 Series (Continued)

D-3200S
(High-Voltage Version of
Standard D-3100S) (Continued)

Mating Dimensions

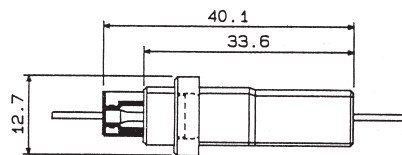

Panel/Free-Hanging Type

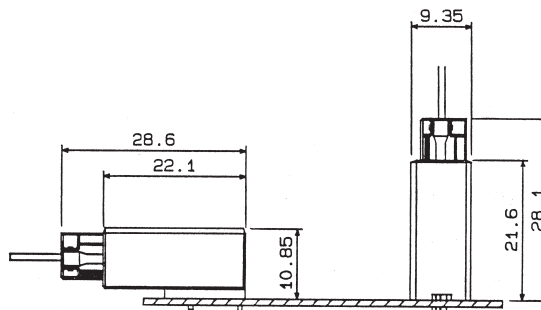

Horizontal/Vertical Type

External Dimensions
Receptacle Housing

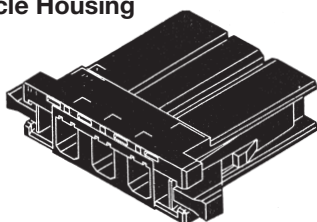

Mating Tab Connector

Part Number:

- 179553-□ □-316131-□
- 179552-□ □-917337-□
- 179276-□ □-178136-□
- 178138-□ □-917338-□
- 179277-□ □-316132-□
- 316130-□ □-316133-□

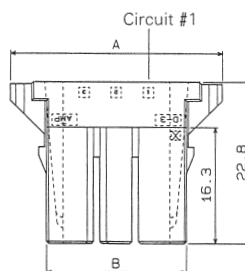
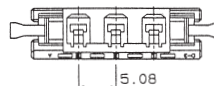

No. of Pos.	Part Number	Dimensions	
		A	B
2	□-178128-2	24.62	14.16
3	□-178128-3	29.7	19.24
4	□-178128-4	34.78	24.32
5	□-178128-5	39.86	29.4
6	□-178128-6	44.94	34.48

5-and 6-position receptacle housings differ slightly in shape with each other. Check with diagram.

Tab Housing

Mating Receptacle Housing

Part Number:

- 178128-□

Panel Type

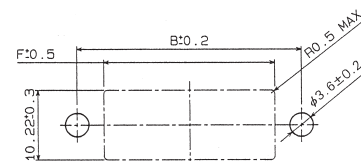
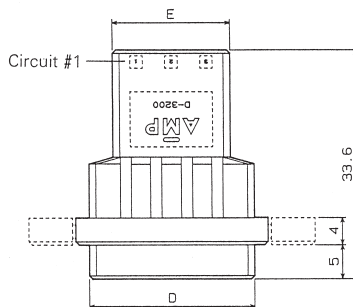
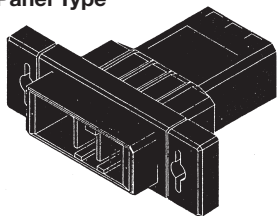

Panel Cutout

When mounting panel from the front, apply clamping torque of less than 49N [11 lbf].

Free-Hanging Type

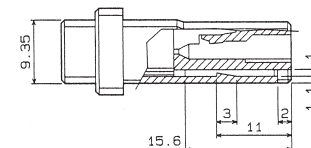
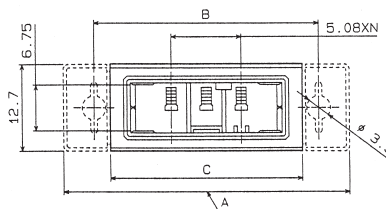
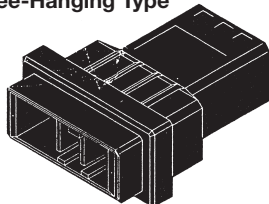

No. of Pos.	Part Number		Dimensions					
	Panel Type	Free-Hanging Type	A	B	C	D	E	F
2	□-179553-2	□-179552-2	36.83	28	23.03	19.08	12.08	20
3	□-179553-3	□-179552-3	41.91	33	28.11	24.16	17.16	25
4	□-179553-4	□-179552-4	46.99	38	33.19	29.24	22.24	30

D-3000 Series (Continued)

D-3200S
(High-Voltage Version of
Standard D-3100S) (Continued)

Board-mounting Tab Header (Horizontal Type)

Mating Receptacle Housing
Part Number:
□-178128-□

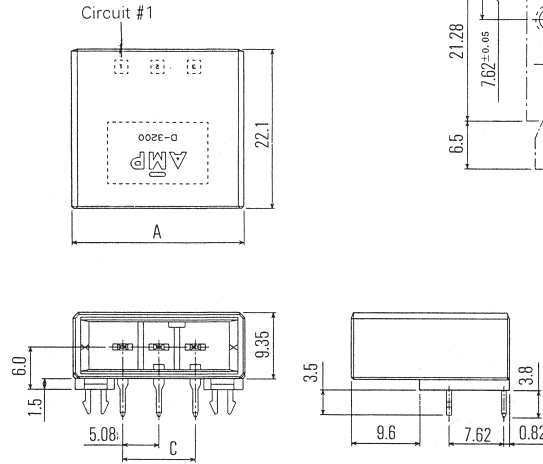
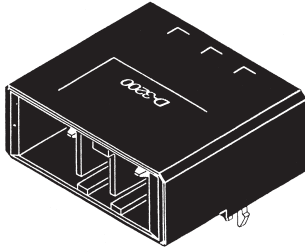

PC Board Layout
Acceptable Board Thickness:
1.6-2.4±0.1

Solder tine section is 0.64 sq.

No. of Pos.	Part Number	Dimensions		
		A	B	C
2	□-179276-□	19.08	12.7	5.08
3	□-178138-□	24.16	17.78	10.16
4	□-179277-□	29.24	22.86	15.24
5	□-316130-□	34.32	27.84	20.32
6	□-316131-□	39.4	33.02	25.4

Tube Package Dimensions (Ref.)

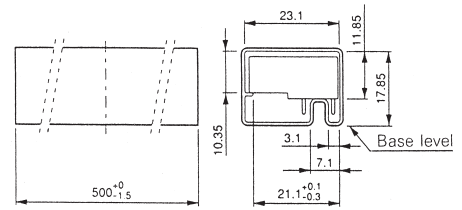

Board-mounting Tab Header (Vertical Type)

Mating Receptacle Housing
Part Number:
□-178128-□

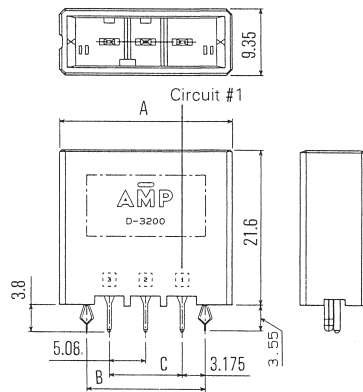
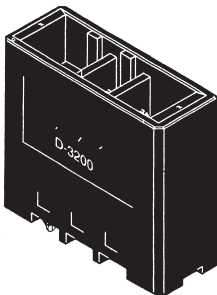

PC Board Layout
Acceptable Board Thickness:
1.6-2.4±0.1

Solder tine section is 0.64 sq.

No. of Pos.	Part Number	Dimensions		
		A	B	C
2	□-917337-□	19.08	11.43	5.08
3	□-178136-□	24.16	16.51	10.16
4	□-917338-□	29.24	21.59	15.24
5	□-316132-□	34.32	26.67	20.32
6	□-316133-□	39.4	31.75	25.4

Tube Package Dimensions (Ref.)

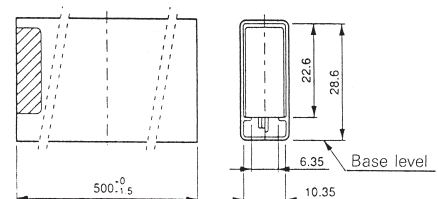

D-3000 Series (Continued)

D-3200S SMT Type

Receptacle Housing and Board Mount Tab Header

Appearance Dielectric Withstanding Voltage: 2,200 V (1 min.)
Voltage Rating: 600 V (when one connector is used)

Receptacle Housing

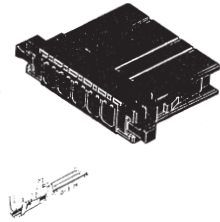

Board-Mounting Tab Header

(Horizontal Type)

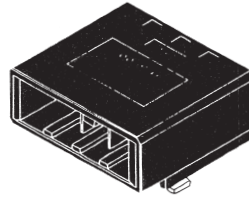

Receptacle Contact.....For each line of contacts, refer to the appropriate page.

No. of Positions	Keying	Part Number of Receptacle Housing*	Part Number of Board-Mount Tab Header
			Horizontal Type
2	X	1-178128-2	—
3	X	1-178128-3	1-917389-□
4	X	1-178128-4	—
5	X	1-178128-5	—
6	X	1-178128-6	—

Note: Enter the following plating codes in Part Number suffix-□. Gold plating only for SMT Type.

-2 = 0.38µm thick gold plating,

-3 = 0.76µm thick gold plating

*Part Numbers are of the same design as D-3200S Series. For dimensions, refer to D-3200S Series. Header material is PPS.

Applications

Servomotors/Inverters-Typical Applications

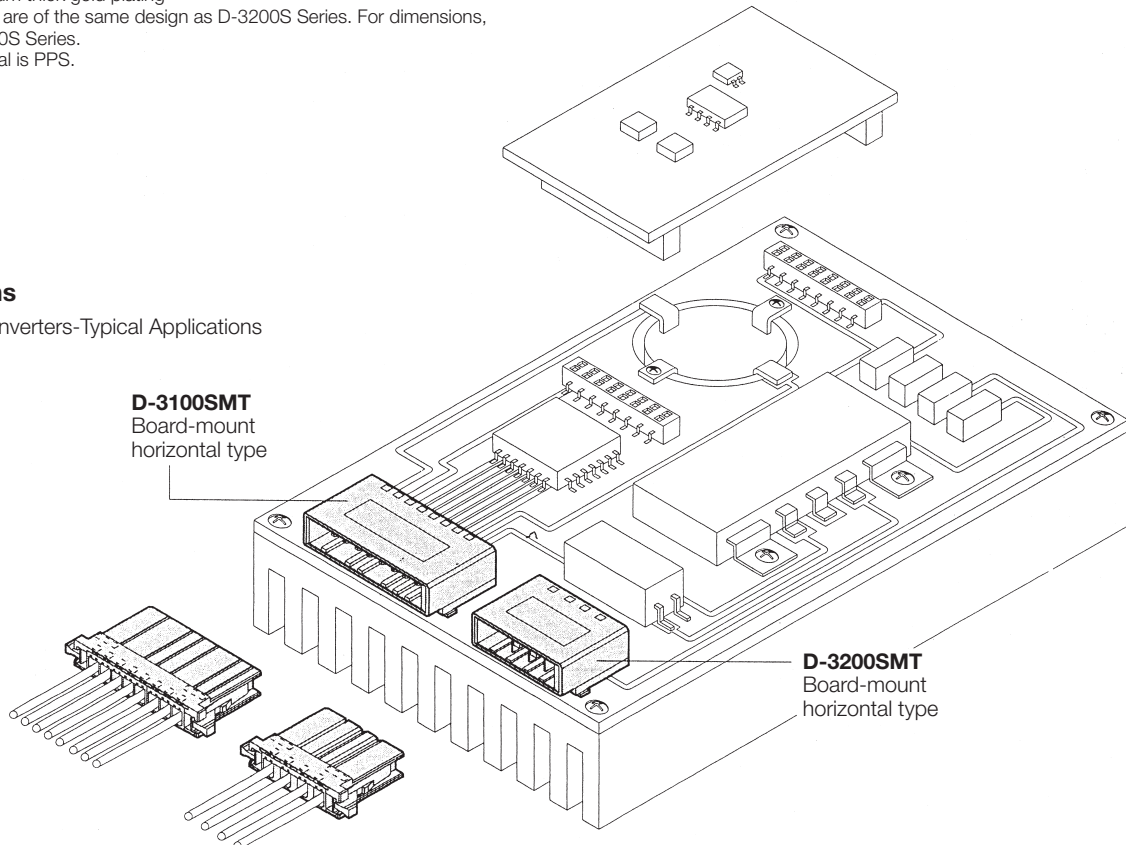

D-3000 Series

D-3000 Series (Continued)

D-3200S SMT Type (Continued)

Mating Dimensions

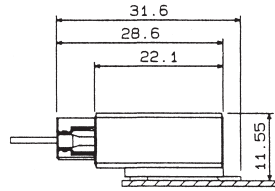

Horizontal Type

External Dimensions

Board-mount Tab Header (Horizontal Type)

Mating Receptacle Housing
Part Number:
1-178128-3

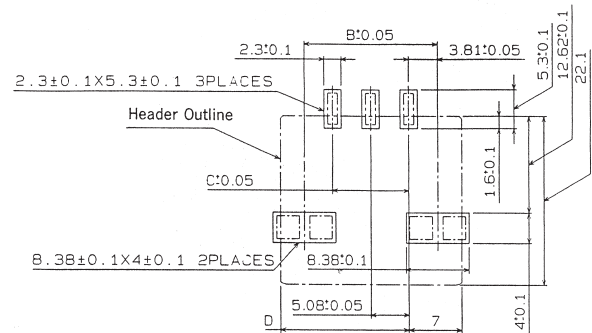
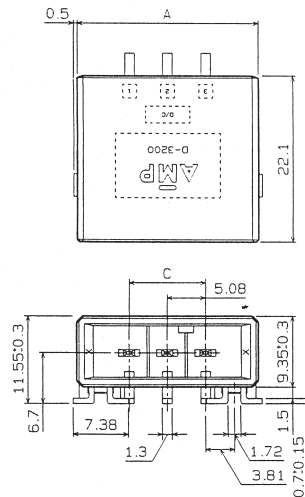
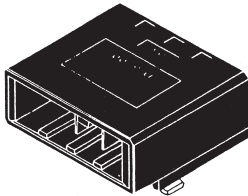

PC Board Layout

Tube Package Dimensions (Ref.)

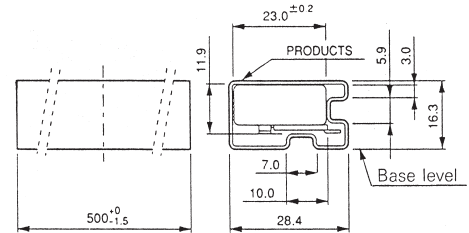

No. of Pos.	Part Number of Tab Header	Dimensions			
		A	B	C	D
3	1-917389-□	24.16	17.78	10.16	17.16

D-3000 Series (Continued)

D-3200M — Modular Type

Appearance Connectors can be used in modular configurations in combination with D-3200S. Ideally suited for allocation of power circuits.
 Board mounting pitch: Horizontal Type 200 x 200 mils (5.08 x 5.08 mm)
 Vertical Type 200 x 300 mils (5.08 x 7.62 mm)
 Dielectric Withstanding Voltage: 2,200 V (for one minute)
 Voltage Rating: 600 V (per connector)

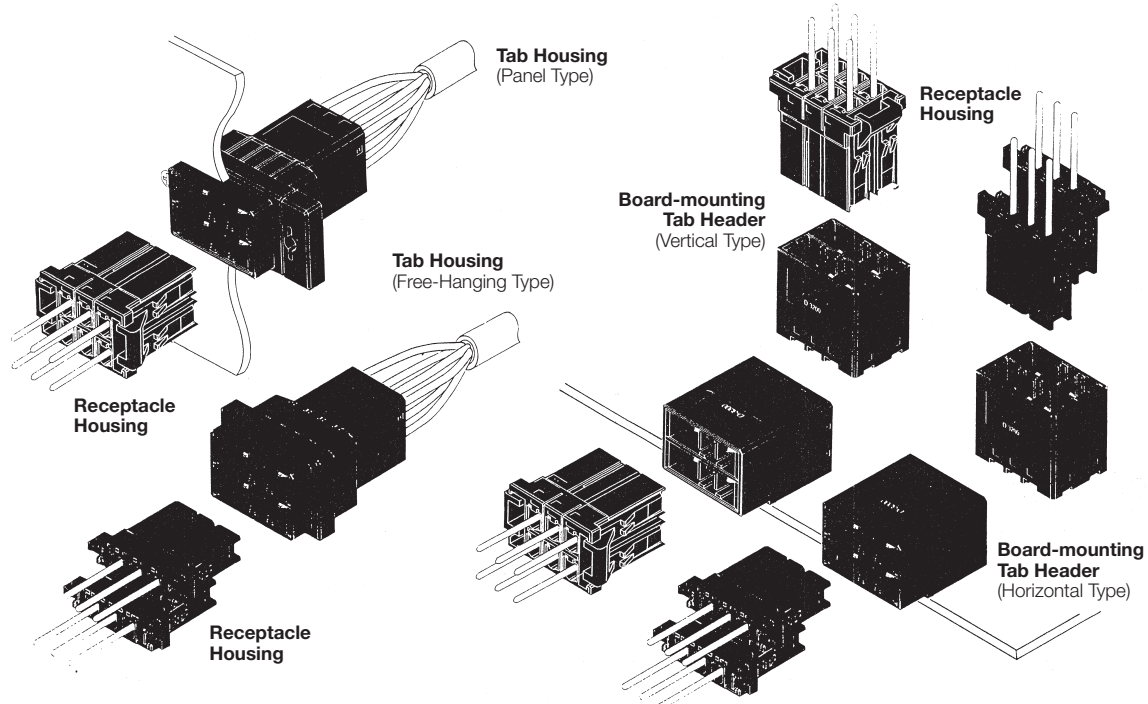

Receptacle Housing Tab Housing Board-mounting Tab Header

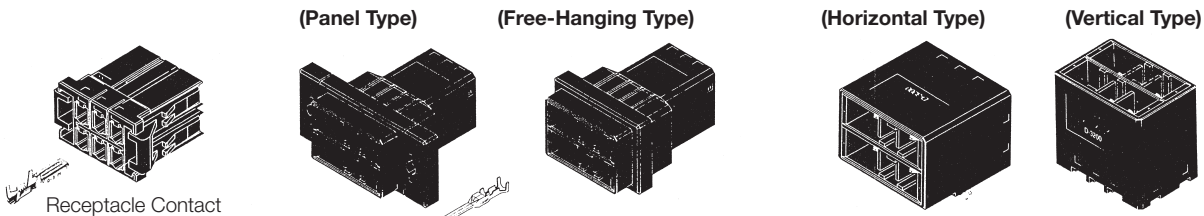

Tab Contact.....For each line of contacts, refer to the appropriate page.

Part Number Chart

No. of Pos.	Keying	Receptacle Housing	Tab Housing*			Board-Mounting Tab Header*	
			Panel Type	Free-Hanging Type	L Fitting	Horizontal Type	Vertical Type
6	XX	1-178129-6	1-179555-3	1-179554-3	S	1-178139-□	1-178140-□
	YY	2-178129-6	2-179555-3	2-179554-3	S	2-178139-□	2-178140-□
	XY	3-178129-6	3-179555-3	3-179554-3	S	3-178139-□	3-178140-□
	ZZ	—	—	—	S	5-178139-5**	—
	ZX	—	—	—	S	6-178139-5**	—
10	XX	1-917659-5	—	—	—	1-316080-□	1-917657-□
	YY	2-917659-5	—	—	—	2-316080-□	2-917657-□
	XY	3-917659-5	—	—	—	3-316080-□	3-917657-□
12	XX	1-917659-6	1-179555-6	1-179554-6	—	1-316081-□	1-917658-□
	YY	2-917659-6	2-179555-6	2-179554-6	—	2-316081-□	2-917658-□
	XY	3-917659-6	3-179555-6	3-179554-6	—	3-316081-□	3-917658-□
20	XX	1-917659-8	1-179555-8	—	—	—	—

Note: Enter the following plating codes in -□ after Part Numbers: -2 = 0.38µm thick gold plating, -3 = 0.76µm thick gold plating, -5 = Tin plating

*Can also be used in Drawer connector in combination with D-3200M Drawer Type.

**Receptacle shall be used in combination of X keying and Z keying of 3 pos. D-3200S.

D-3000 Series (Continued)

D-3200M — Modular Type

(Continued)

Keying

This product (D-3200M) is provided with keying to help prevent mismatching of the connector halves. Keying is available in three types —XX Type, YY Type and XY Type. (Shown below is the mating surface of Tab Header.) ZZ type and ZX type keying are also available for 6 pos.

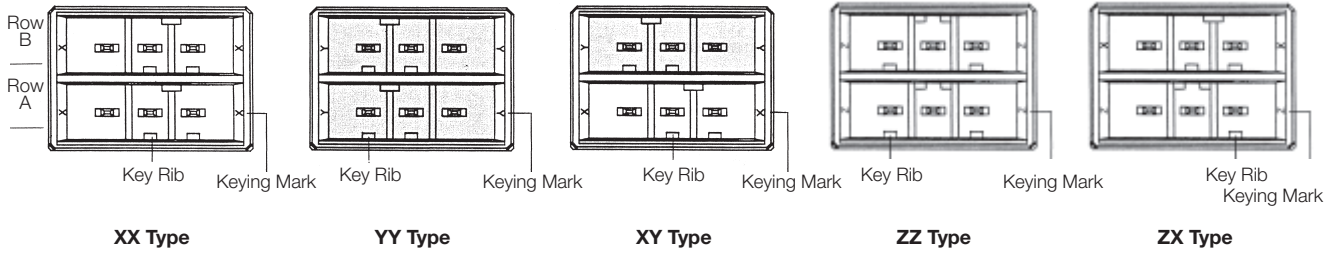

Table of Mating Combinations

Receptacle Housing		Tab Housing		Board-mounting Tab Header	
1 Row 3 Positions (D-3200S) 	X Type		1 Row, (D-3200S) Panel Type	X Type Panel Type	1 Row, (D-3200S) Horizontal Type
	Y Type		Free-Hanging Type	Y Type Panel Type	Vertical Type
2 Rows 6 Positions 	XX Type		2 Rows Panel Type	XX Type Panel Type	2 Rows Horizontal Type
	YY Type		Free-Hanging Type	YY Type Panel Type	Vertical Type
	XY Type		Free-Hanging Type	XY Type Panel Type	Vertical Type

The housing with asterisk (*) same as D-3200S Series.

D-3000 Series (Continued)

D-3200M — Modular Type

(Continued)

Mating Dimensions

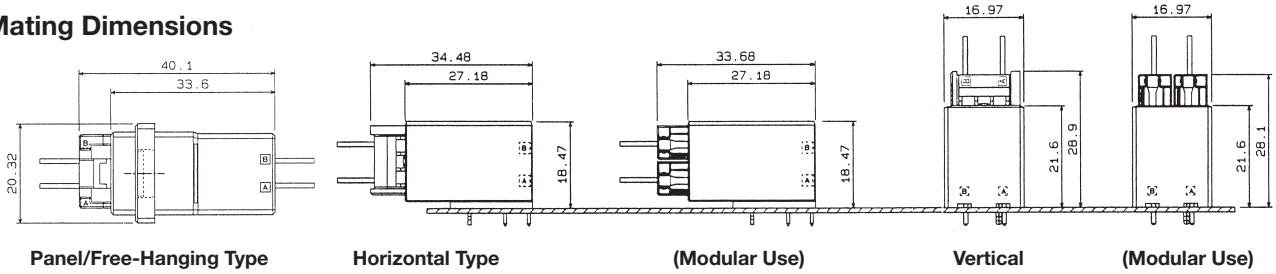

External Dimensions

Receptacle Housing

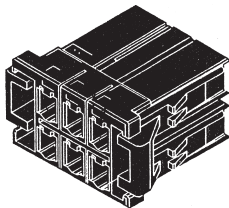

Mating Receptacle Housing Part Number:

- 178139-□ □-917657-□
- 316080-□ □-917658-□
- 316081-□ □-179555-□
- 178140-□ □-179554-□

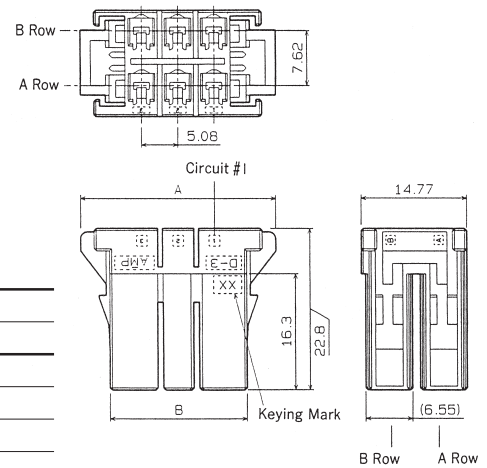

No. of Pos.	Part Number	Dimensions	
		A	B
6	□-178129-6	27.3	19.24
10	□-917659-5	37.46	29.4
12	□-917659-6	42.54	34.48
20	□-917659-8	62.86	54.8

Tab Housing

Panel Type

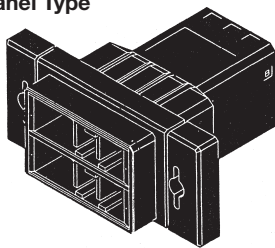

Mating Receptacle Housing Part Number:

- 178129-□
- 917659-□

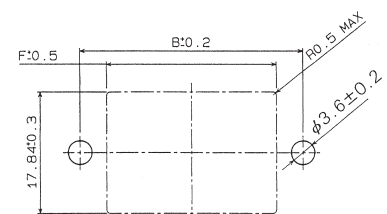
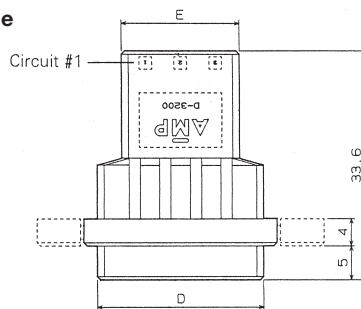

Panel Cutout

When mounting panel from the front, apply clamping torque of less than 49N [11 lbf].

Free-Hanging Type

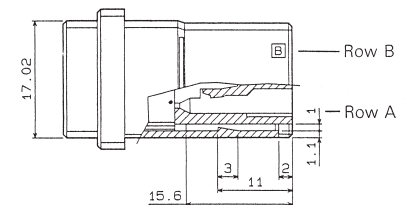
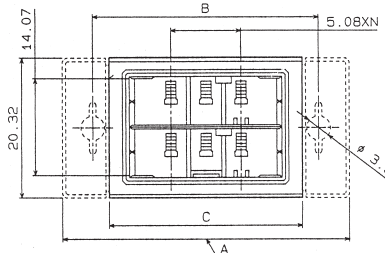
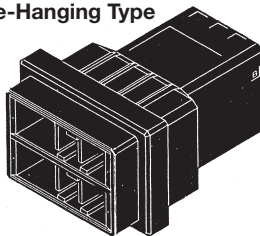

No. of Pos.	Part Number		Dimensions					
	Panel Type	Free-Hanging Type	A	B	C	D	E	F
6	□-179555-3	□-179554-3	41.91	33	28.11	24.16	17.16	25
12	□-179555-6	□-179554-6	57.91	49	43.35	39.4	32.4	41
20	□-179555-8	—	78.23	70	—	59.72	52.72	61

D-3000 Series

D-3000 Series (Continued)

D-3200M — Modular Type

(Continued)

Board-mounting Tab Header (Horizontal Type)

Mating Receptacle Housing

Part Number:

□-178129-□

□-917659-□

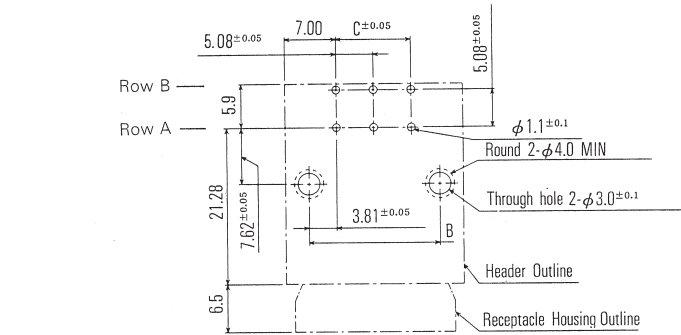
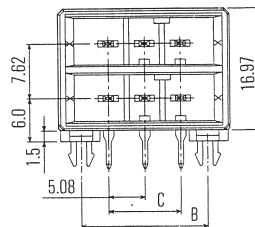
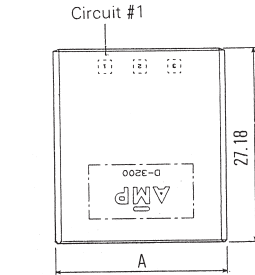
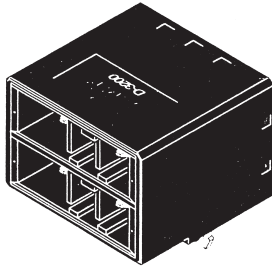

PC Board Layout

Acceptable Board Thickness:
1.6-2.4±0.1

Tube Package Dimensions (Ref.)

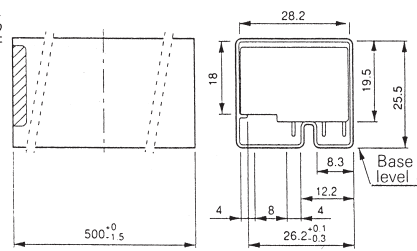

No. of Pos.	Part Number	Dimensions		
		A	B	C
6	□-178139-□	24.16	17.78	10.16
10	□-316080-□	34.32	27.94	20.32
12	□-316081-□	39.4	33.02	25.4

Board-mounting Tab Header (Vertical Type)

Mating Receptacle Housing

Part Number:

□-178129-□

□-917659-□

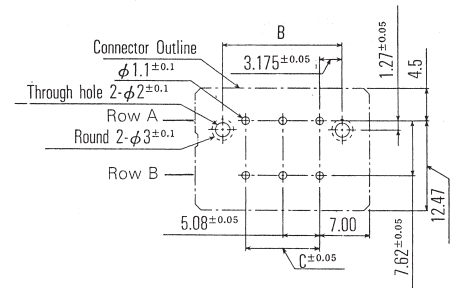
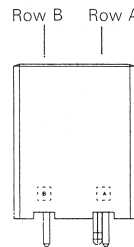
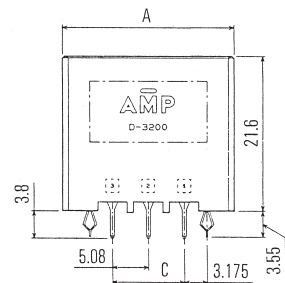
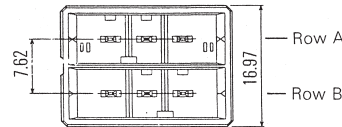
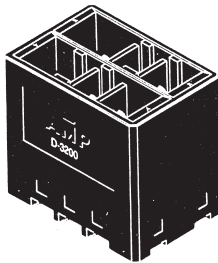

PC Board Layout

Acceptable Board Thickness:
1.6-2.4±0.1

Tube Package Dimensions (Ref.)

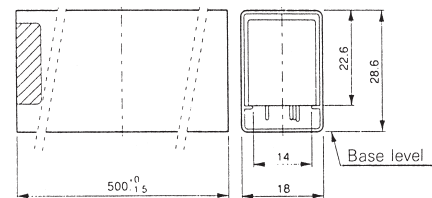

No. of Pos.	Part Number	Dimensions		
		A	B	C
6	□-178140-□	24.16	16.51	10.16
10	□-917657-□	34.32	26.67	20.32
12	□-917658-□	39.4	31.75	25.4

D-3000 Series (Continued)

D-3200M — Drawer Type

Appearance Board mounting pitch: Horizontal Type 200 x 200 mils (5.08 x 5.08 mm)
 Vertical Type 200 x 300 mils (5.08 x 7.62 mm)
 Dielectric Withstanding Voltage: 2,200 V (for one minute) Voltage Rating: 600 V (per connector)

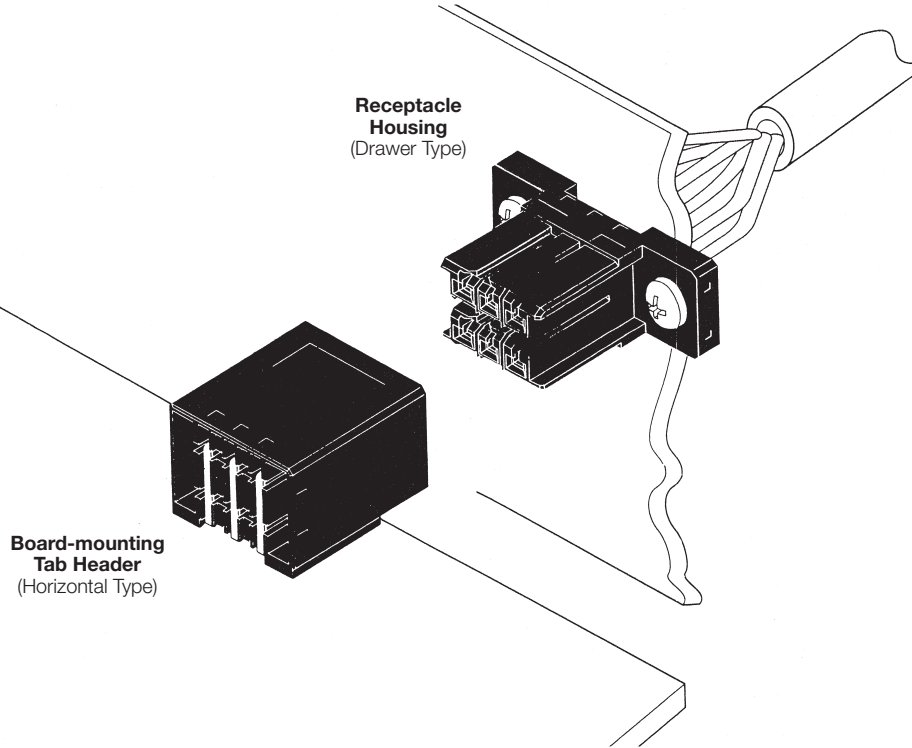

D-3000 Series

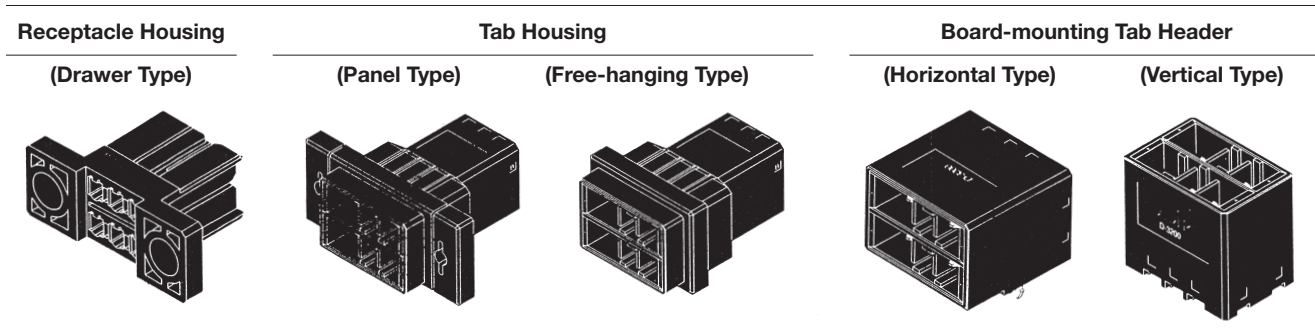

Part Number Chart

No. of Pos.	Keying	Receptacle Housing (Drawer Type)	Tab Housing*		Board-mounting Tab Header*	
			Panel Type	Free-Hanging Type	Horizontal Type	Vertical Type
6	XX	1-917266-3	1-179555-3	1-179554-3	1-178139-□	1-178140-□
	YY	—	2-179555-3	2-179554-3	2-178139-□	2-178140-□
	XY	—	3-179555-3	3-179554-3	3-178139-□	3-178140-□

Note: Enter the following plating codes in -□ after Part Numbers:
 -2 = 0.38µm thick gold plating, -3 = 0.76µm thick gold plating,
 -5 = Tin plating

Panel Mounting Screw

Part Number
900167-1

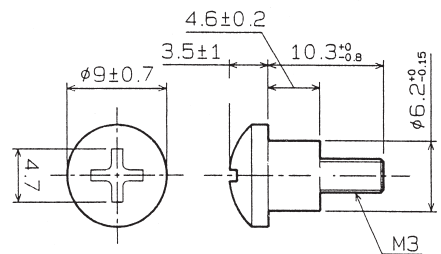
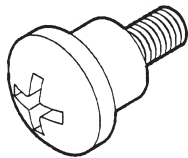

D-3000 Series (Continued)

D-3200M — Drawer Type

(Continued)

Mating Dimensions

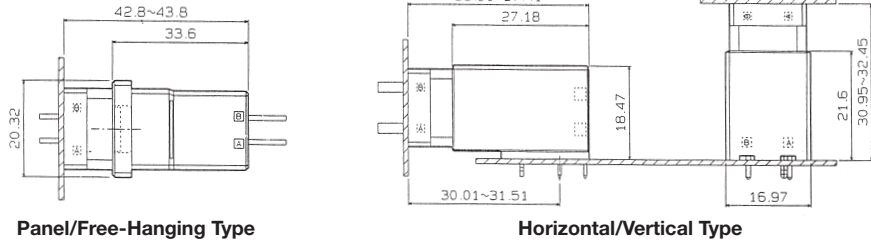

External Dimensions

Receptacle Housing

Mating Tab Connector

Part Number:

- 179555-□
- 179554-□
- 178139-□
- 178140-□

Drawer Type

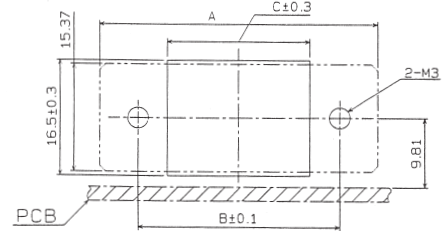
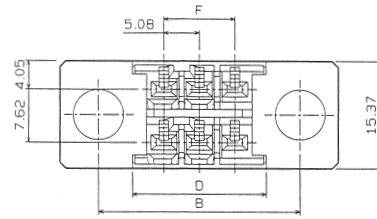
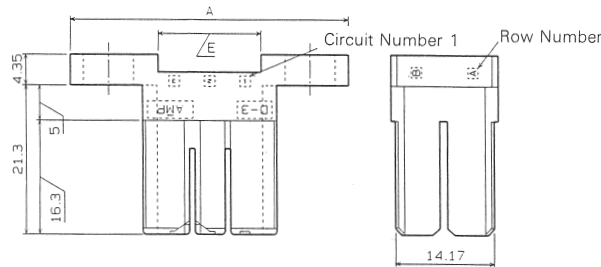
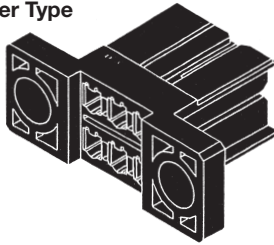

No. of Pos.	Part Number	Dimensions					
		A	B	C	D	E	F
6	□-917266-3	40	29	20.5	19.24	14.76	10.16

Tab Housing

Mating Receptacle Housing

Part Number:

- 917266-□

Panel Type

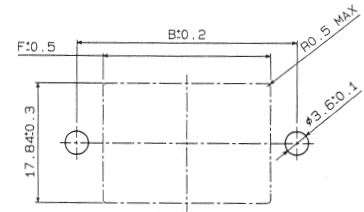
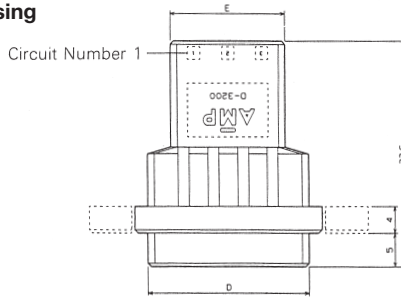
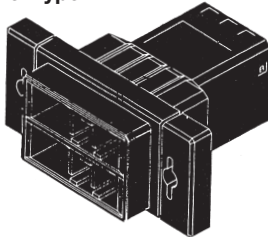

Panel Cutout

When mounting panel from the front, apply clamping torque of less than 49N [11 lbf].

Free-hanging Type

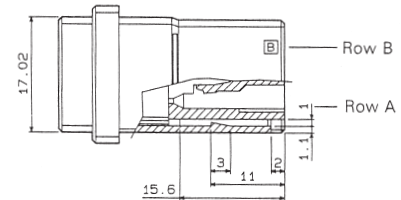
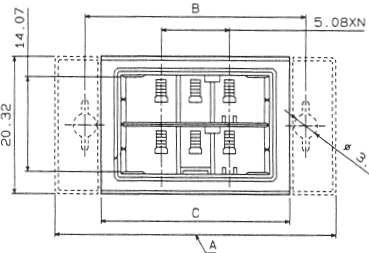
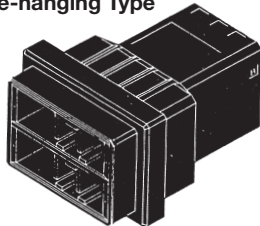

No. of Pos.	Part Number		Dimensions					
	Panel Type	Free-hanging Type	A	B	C	D	E	F
6	□-179555-3	□-179554-3	41.91	33	28.11	24.16	17.16	25

D-3000 Series (Continued)

D-3200M — Drawer Type

(Continued)

Board-mounting Tab Header (Horizontal Type)

Mating Receptacle Housing

Part Number:

□-917266-□

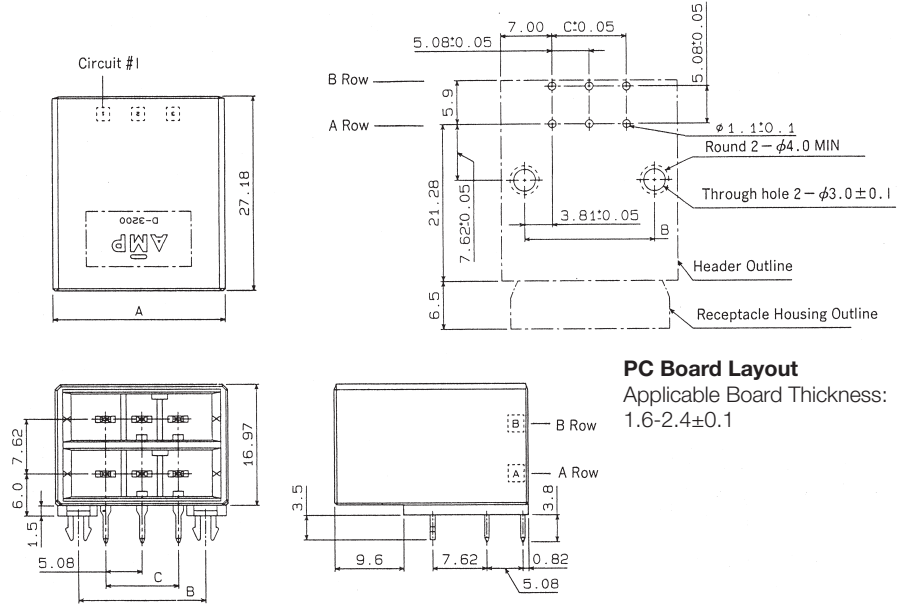
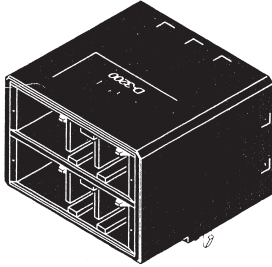

PC Board Layout
Applicable Board Thickness:
1.6-2.4±0.1

No. of Pos.	Part Number	Dimensions		
		A	B	C
6	□-178139-□	24.16	17.78	10.16

Board-mounting Tab Header (Vertical Type)

Mating Receptacle Housing

Part Number:

□-917266-□

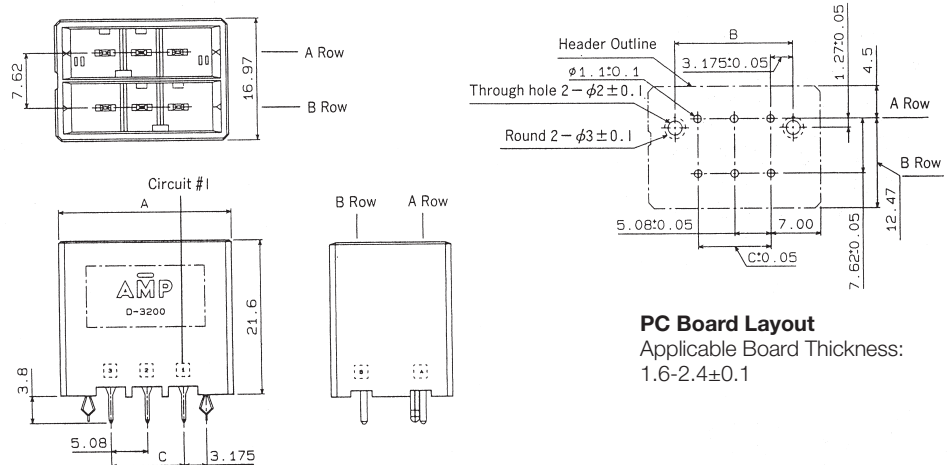
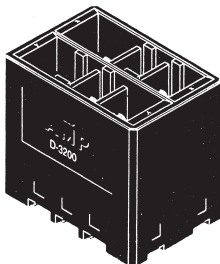

PC Board Layout
Applicable Board Thickness:
1.6-2.4±0.1

No. of Pos.	Part Number	Dimensions		
		A	B	C
6	□-178140-□	24.16	16.51	10.16

D-3000 Series

D-3000 Series (Continued)

D-3200T — 3-Row Type

Appearance Board-mounting pitch: Horizontal Type 200 x 200mils (5.08 x 5.08mm)
Dielectric Withstanding Voltage: 2,200 V (for one minute) Voltage Rating: 600 V (per connector)

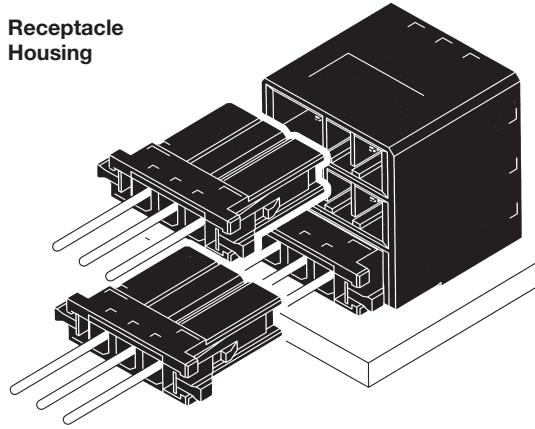

Mating Dimensions

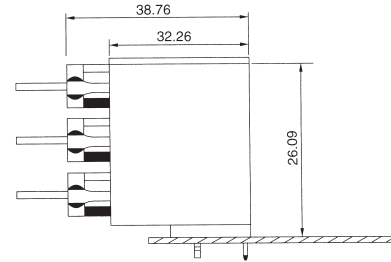

Horizontal Type

Keying

This product (D-3200T) is provided with keying to help prevent mismatching of the connector halves. Keying is available in four types-XXX Type, XXY Type, YYX Type and XYX Type. (Shown below is the mating surface of Tab Header.)

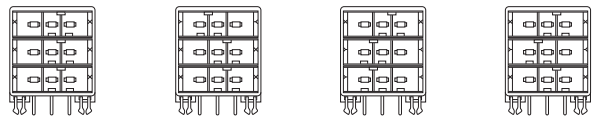

XXX Type XXY Type YYX Type XYX Type

Part Number Chart

No. of Pos.	Keying	Board-mounting Tab Header
		Horizontal Type
9	XXX	1-1123624-□
	XXY	3-1123624-□
	YYX	4-1123624-□
	XYX	5-1123624-□

Note: Enter following plating codes in □ after Part Numbers:
-2 : 0.38µm thick gold plating
-5 : Tin plating

Board-mount Tab Header (Horizontal Type)

Mating Receptacle Housing Part Number:
□-178128-3

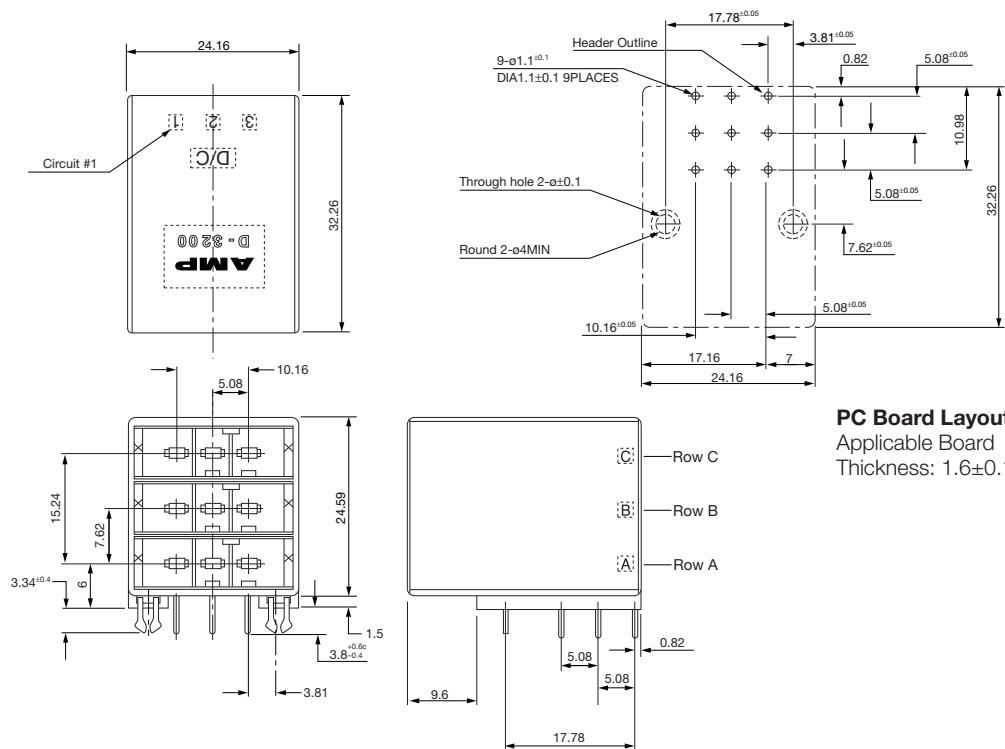
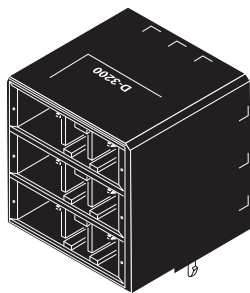

PC Board Layout
Applicable Board Thickness: 1.6±0.1

D-3000 Series (Continued)

**D-3400F — Skyscraper
Connectors**

Appearance Board-mounting width reduced through increased heights. Compatible with increased I/Os.
 Board-mounting pitch: Horizontal Type 150 x 150 mils (3.81 x 3.81 mm)
 Dielectric Withstanding Voltage: 1,500 V (for one minute) Voltage Rating: 250 V

D-3000 Series

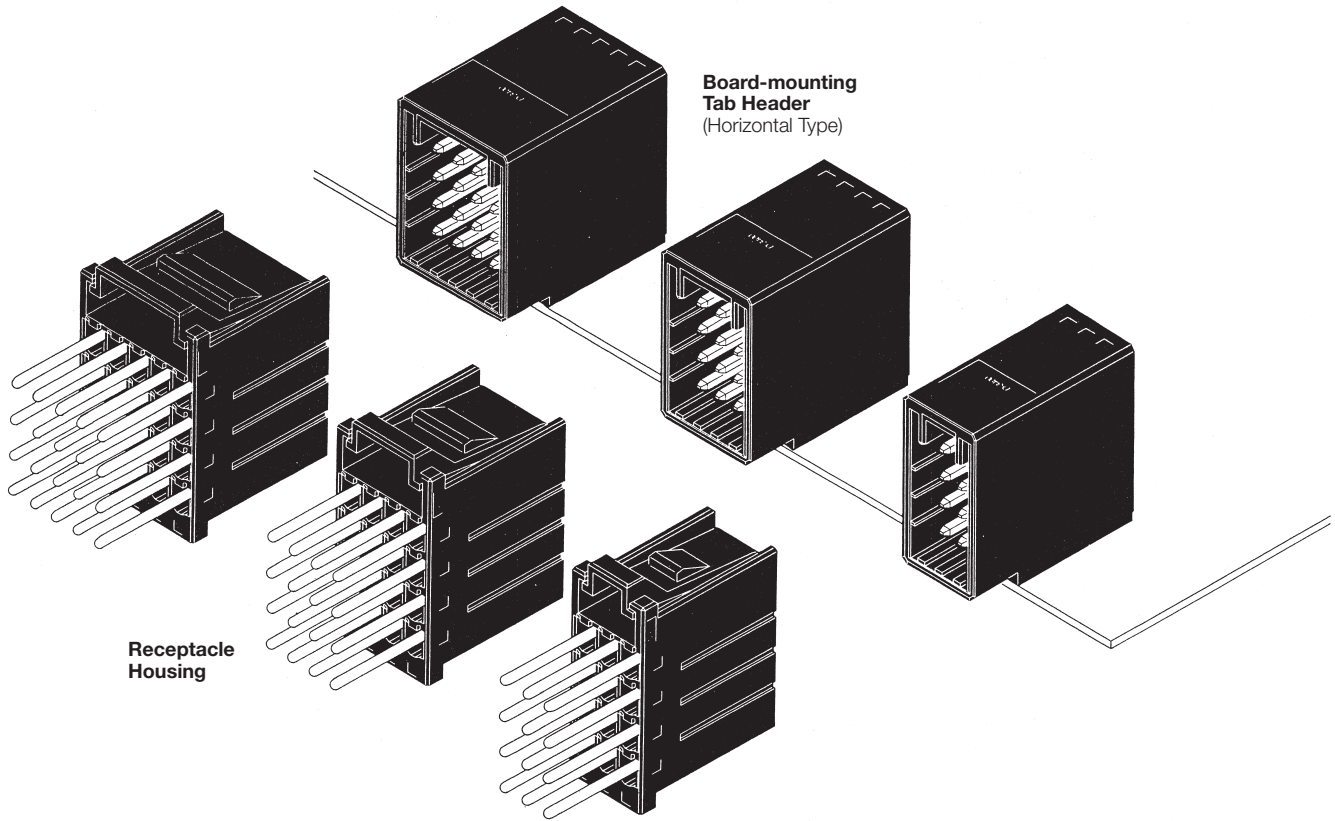

Receptacle Housing

Board-mounting Tab Header
(Horizontal Type)

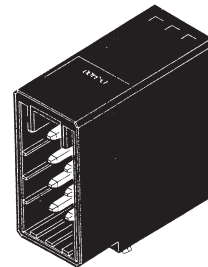
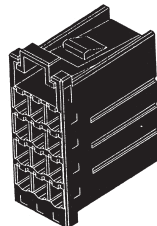

Part Number Chart

No. of Pos.	Receptacle Housing	Board-mounting Tab Header (Horizontal Type)
12	178214-1	178216-□
16	—	—
20	917249-1	917251-□

Note: Enter the following plating codes in -□ after Part Numbers:
 -2 = 0.38µm thick gold plating, -3 = 0.76µm thick gold plating,
 -5 = Tin plating

D-3000 Series (Continued)

D-3400F — Skyscraper Connectors (Continued)

Mating Dimensions

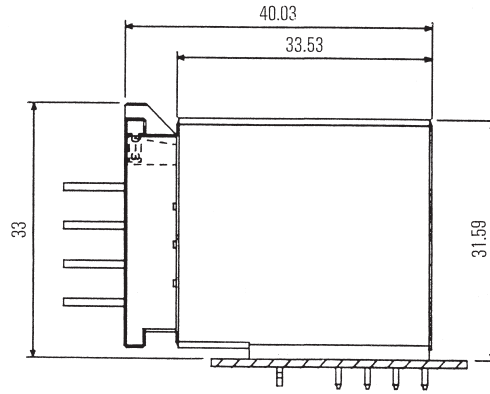

Horizontal Type

Receptacle Housing

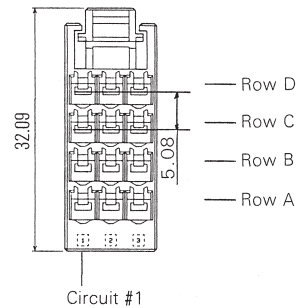
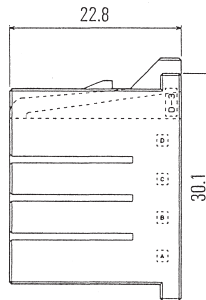
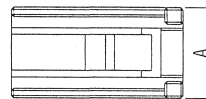
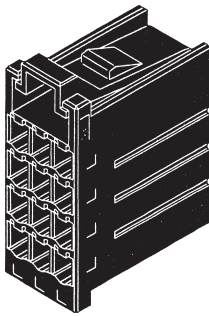

No. of Pos.	Part Number	Dimensions	Mating Tab Header Part Number
		A	
12	178214-1	12.22	178216-□
16	—	—	—
20	917249-1	19.84	917251-□

D-3000 Series (Continued)

D-3400F — Skyscraper Connectors (Continued)

Board-mounting Tab Header (Horizontal Type)

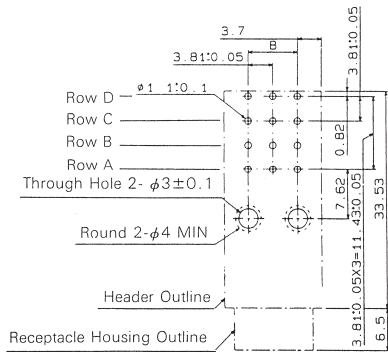
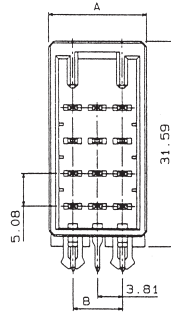
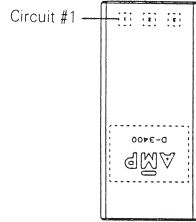
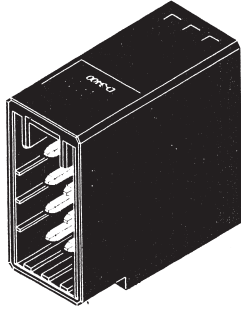

PC Board Layout

Acceptable Board Thickness:
1.6-2.4±0.1

Tube Package Dimensions For 12 Pos.

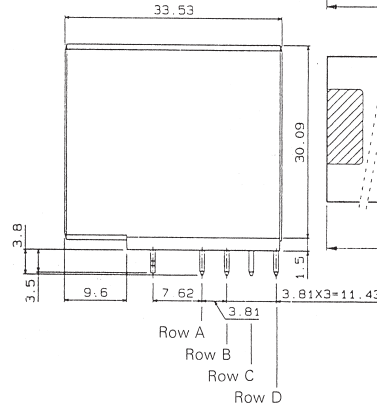
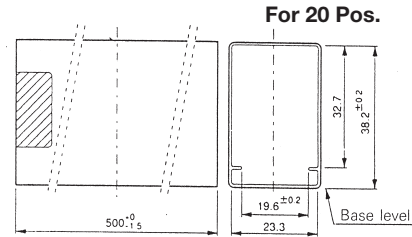
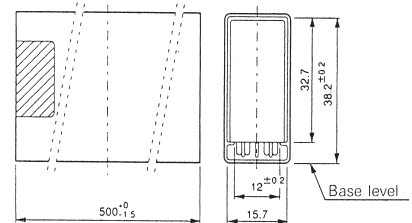

No. of Pos.	Part Number	Dimensions		Mating Receptacle Housing Part Number
		A	B	
12	178216-□	15.02	7.62	178214-1
16	—	—	—	—
20	917251-□	22.64	15.24	917249-1

Testing Advice

There are two major causes for faulty contact of the connector. They are:

- (1) Scooping of contacts at mating/unmating
 - With this Dynamic Series, each connector is designed to protect contacts against scooping very effectively.
- (2) Widening of contact gap by forcing tester bar, etc., into receptacle contacts when making continuity check.
 - Test bars that are commercially available (2 mm) cannot be pushed in from the entry port of housing. Never do continuity check by inserting clips, etc. Failure may also be caused by mis-insertion of the extraction tool. Be careful when you use the tool.

(Recommended methods of continuity check)

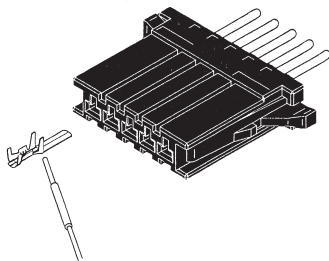

① Utilize tab contacts.

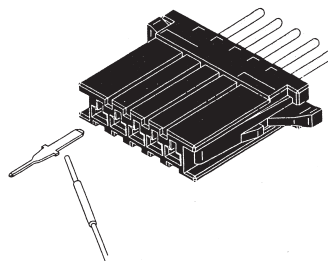

② Extract contacts from Board-mounting Vertical Type connector and insert them for testing.

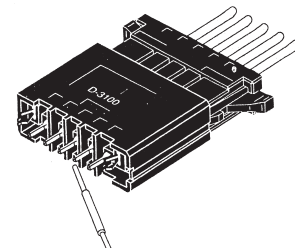

③ The best method is to use Board-mounting Vertical type connector.

D-3000 Series (Continued)

D-3500D — Sensor Connectors

Appearance Ideally suited for sensors used in robotics and machine tools. Also used for power distribution.
 Board mounting pitch: 200 x 200 mils (5.08 x 5.08 mm)
 Dielectric Withstanding Voltage: 2,200 V (for one minute)
 Voltage Rating: 600 V (per connector)

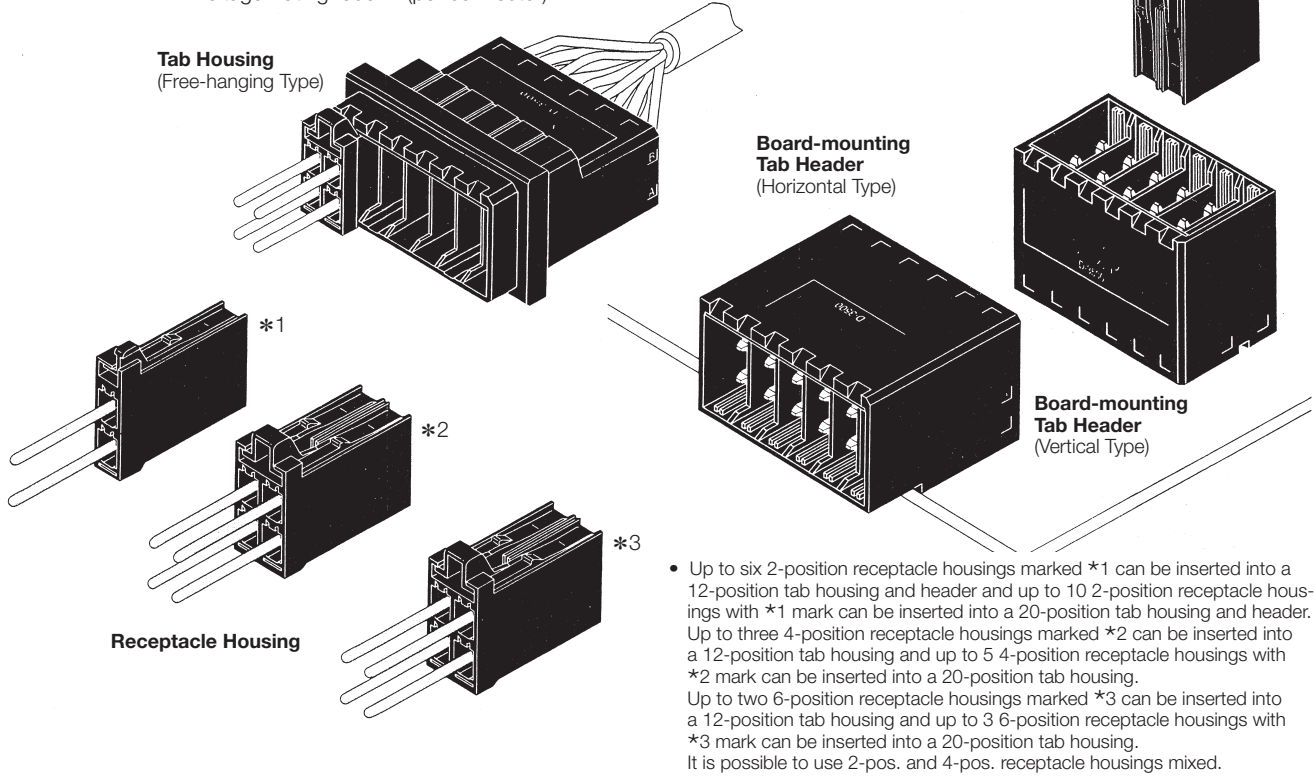

D-3000 Series

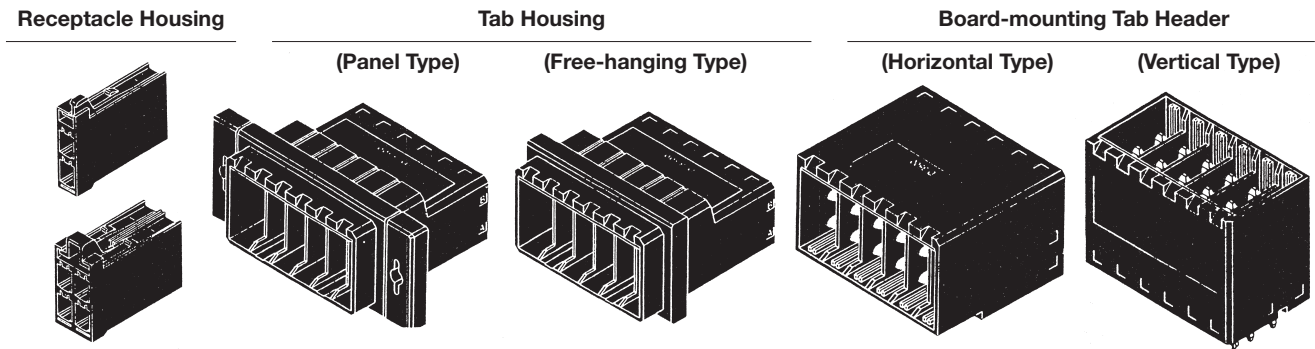

No. of Pos.	Receptacle Housing	Tab Housing		L Fitting	Board-mounting Tab Header	
		Panel Type	Free-hanging Type		Horizontal Type	Vertical Type
2	175362-□	—	—	—	—	—
4	175363-□	—	—	—	1376133-□	—
6	1318095-□	—	—	—	—	—
12	—	□-917241-6	□-917242-6	S	177555-□	316516-□
20	—	□-917241-8	□-917242-8	S	175365-□	316517-□

Note : In the □ after Part Numbers of PC board mount tab headers, please enter the following plating code numbers:
 -2 = 0.38µm thick gold plating, -3 = 0.76µm thick gold plating,
 -5 = Tin plating

The codes for the □ after receptacle housing part numbers and before tab housing part numbers, please refer to the next page.

D-3000 Series (Continued)

D-3500D — Sensor Connectors (Continued)

Mating Dimensions

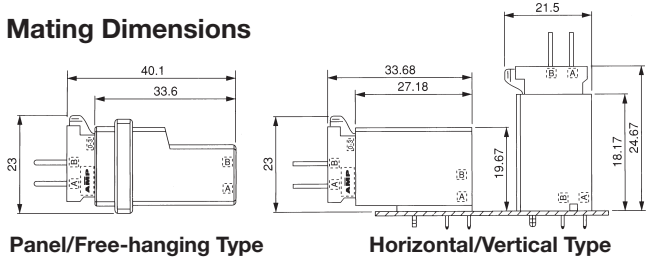

Panel/Free-hanging Type

Horizontal/Vertical Type

Receptacle Housing

Mating Tab Housing Part Number:

- 917241-□ 1376133-□ 175365-□ 316517-□
- 917242-□ 177555-□ 316516-□

(6 Positions)

No. of Pos.	Part Number
6	1318095-1
	1318095-2 (without a key)

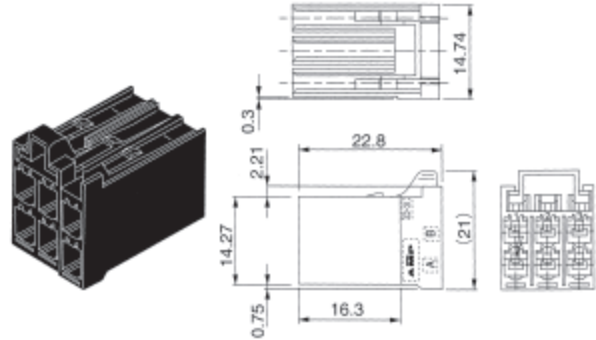

(2 Positions)

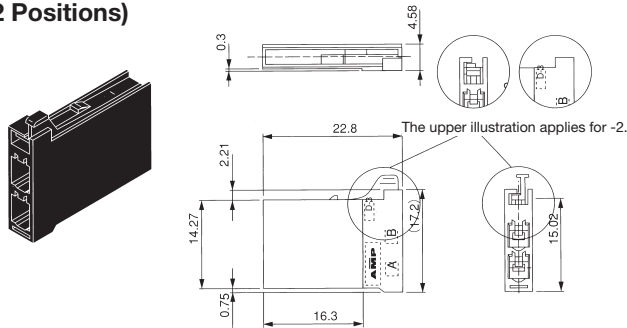

(4 Positions)

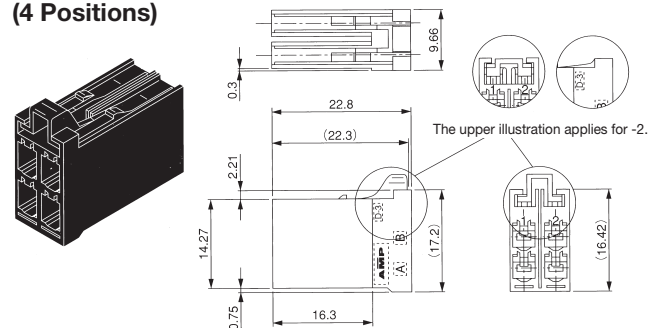

No. of Pos.	Part Number
2	175362-1
	175362-2

The illustrations show -1 type. (-2 type does not have the locking lever.)

No. of Pos.	Part Number
4	175363-1
	175363-2

*-2 type has no locking lever in order not to hinder the adjacent receptacle when removing the receptacle. When removing -2 type receptacle, please use a screwdriver.

Tab Housing

Panel Type

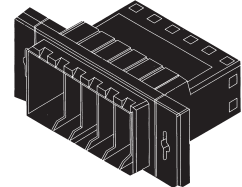

Mating Receptacle Housing Part Number:
 175362-□
 175363-□
 1318095-□

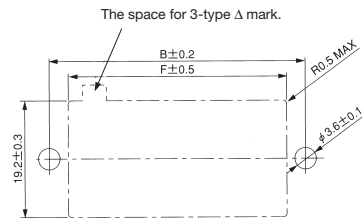
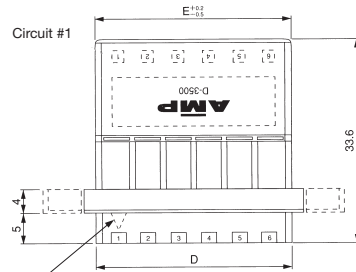

Panel Cutout

When mounting panel from the front, apply clamping torque of less than 49N [11 lbf].

Free-Hanging Type

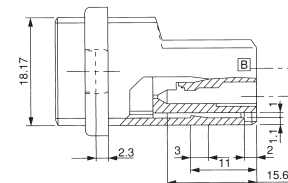
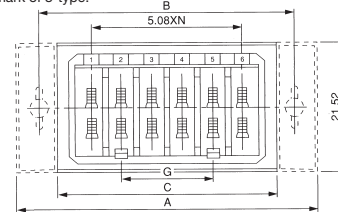
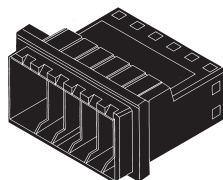

No. of Pos.	Part Number		Dimensions						
	Panel Type	Free-Hanging Type	A	B	C	D	E	F	G
12	917241-6	917242-6	52	43	36.43	32.48	32.48	33.4	15.24
	3-917241-6	3-917242-6							
20	917241-8	917242-8	72	63	56.75	52.8	52.8	53.8	35.56
	3-917241-8	3-917242-8							

*3- type has ∇ mark on top of the circuit No.1 in order to enhance visibility.

D-3000 Series (Continued)

D-3500D — Sensor Connectors (Continued)

Board-mounting Tab Header (Horizontal Type)

Mating Receptacle Housing
Part Number:
 175362-□
 175363-□
 1318095-□

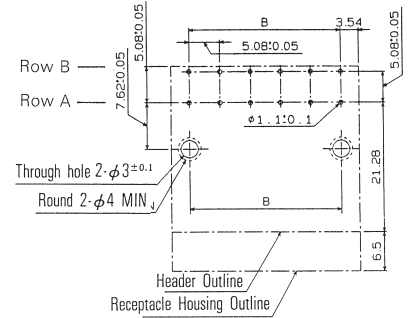
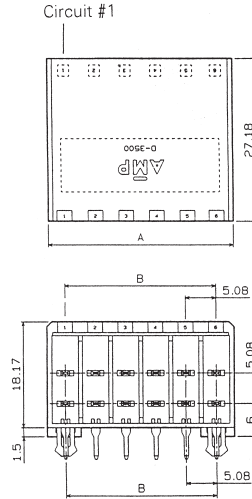
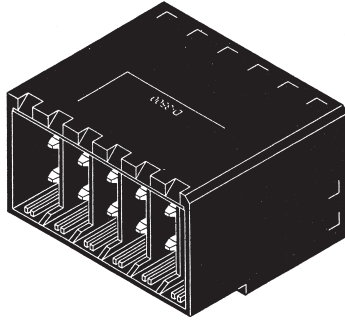

PC Board Layout
 Acceptable Board Thickness:
 1.6-2.4±0.1

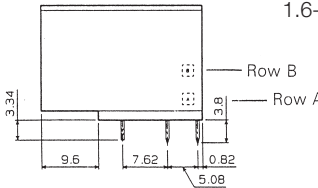

No. of Pos.	Part Number	Dimensions	
		A	B
4	1376133-□	12.16	5.08
12	177555-□	32.48	25.4
20	175365-□	52.8	45.72

Board-mounting Tab Header (Vertical Type)

Mating Receptacle Housing
Part Number:
 175362-□
 175363-□
 1318095-□

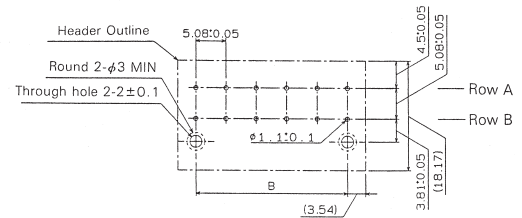
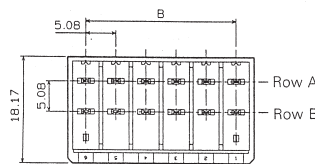
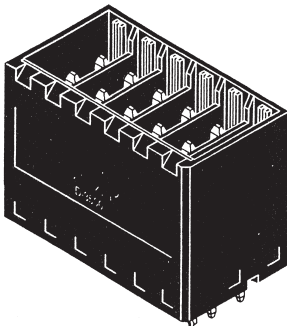

PC Board Layout
 Acceptable Board Thickness:
 1.6-2.4±0.1

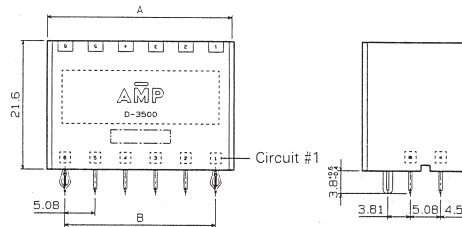

Tube Package Dimensions (Ref.)

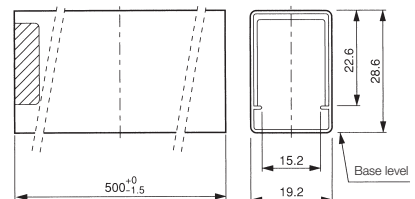

No. of Pos.	Part Number	Dimensions	
		A	B
12	316516-□	32.48	25.4
20	316517-□	52.8	45.72

D-3000 Series (Continued)

D-3700 — Connectors for Exclusive Use with Servomotor

Appearance Dielectric Withstanding Voltage: 1,500 V (for one minute)
Voltage Rating: 250 V

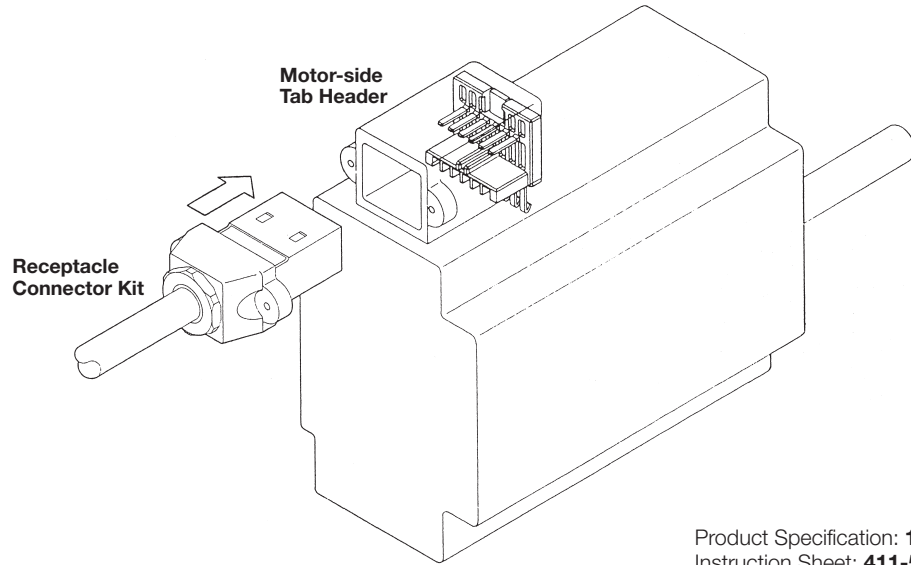

Product Specification: **108-5324**
Instruction Sheet: **411-5747**

Receptacle Connector Kit

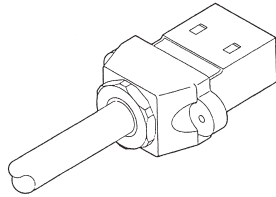

Part Number Chart

No. of Pos.	W/O Contact	Contact (P/N 1-175218-2) including 6 contacts	Remarks
6	176346-7	176346-8	Products with TÜV
	1-176346-7	1-176346-8	—

Applications

Typical Application on Servomotor / Servodriver

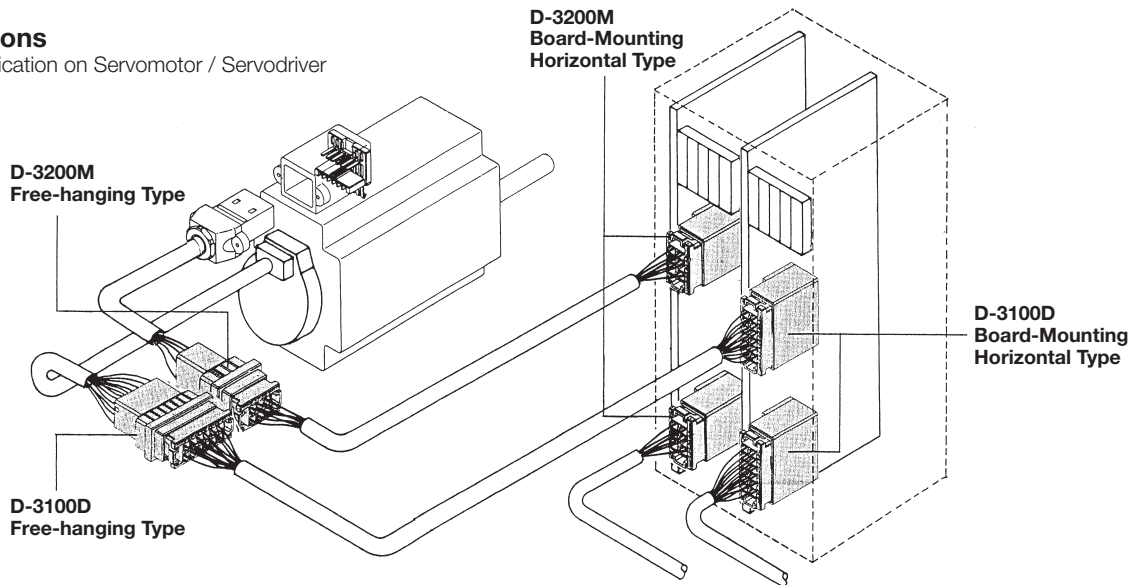

D-3000 Series (Continued)

D-3700 — Connectors for Exclusive Use with Servomotor (Continued)

Mating Dimensions

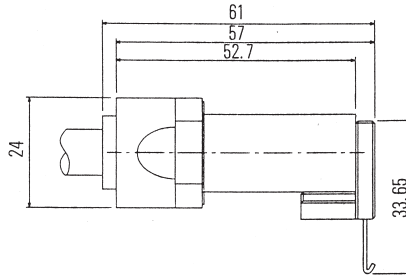

External Dimensions
Receptacle Connector Kit
(Products with CE mark)

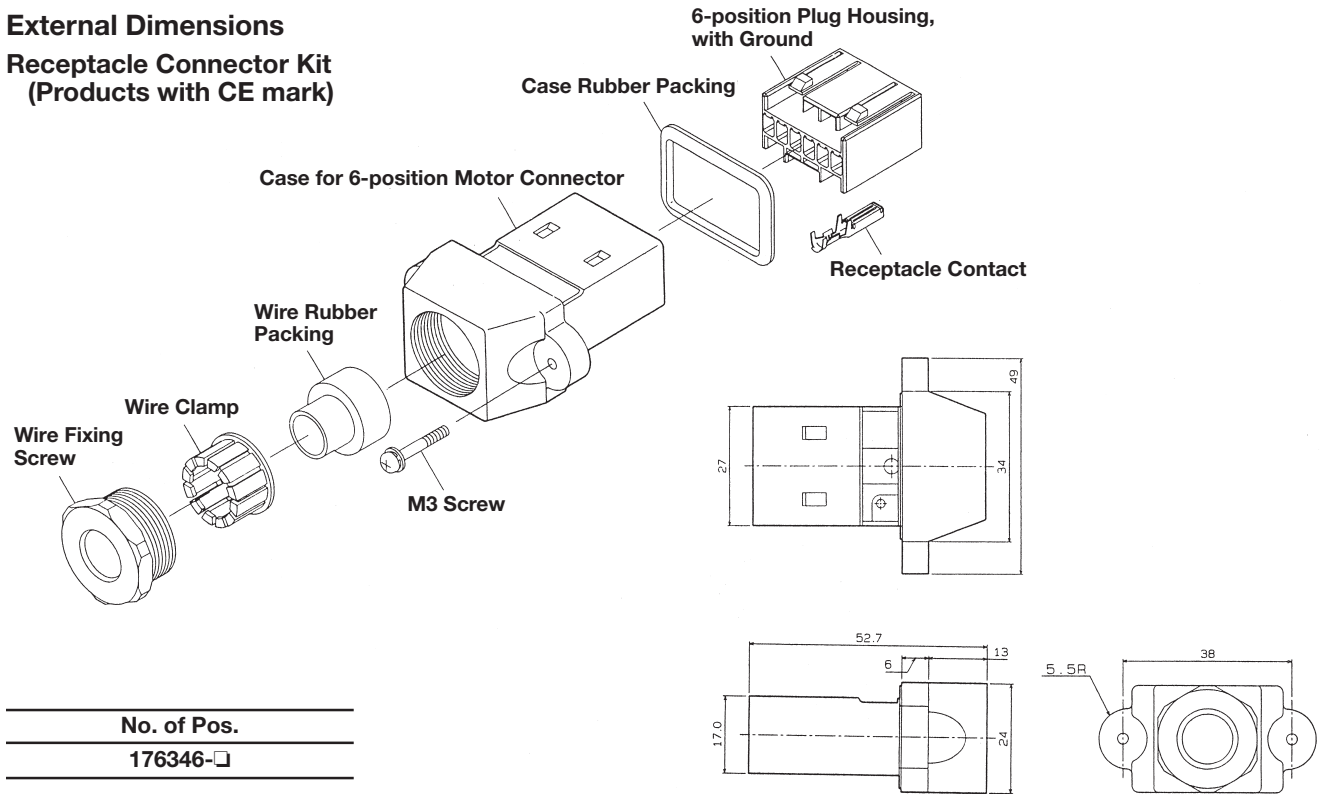

Motor-side Tab Header
(Offered for limited usage)

