

## 1 Features

- Input Voltage Range: up to 30 V
- 3.3-V, 5-V, 12-V, and 15-V Versions Available
- Packaged in the Tiny 3-Lead SOT-23 Package
- 30-V Maximum Input for Operation
- 1.2-V Ensured Maximum Dropout Over Full Load and Temperature Ranges
- 100-mA Ensured Minimum Load Current
- $\pm 5\%$  Ensured Output Voltage Tolerance Over Full Load and Temperature Ranges
- $-40$  to  $+125^\circ\text{C}$  Junction Temperature Range for Operation

## 2 Applications

- Tiny Alternative to LM78Lxx Series and Similar Devices
- Tiny 5-V  $\pm 5\%$  to 3.3-V, 100-mA Converter
- Post Regulator for Switching DC/DC Converter
- Bias Supply for Analog Circuits

## 3 Description

The XB3480M is an integrated linear voltage regulator. It features operation from an input as high as 30 V and an ensured maximum dropout of 1.2 V at the full 100-mA load. Standard packaging for the LM3480 is the 3-lead SOT-23 package.

The 5-V, 12-V, and 15-V members of the XB3480M series are intended as tiny alternatives to industry standard LM78Lxx series and similar devices. The 1.2-V quasi-low dropout of XB3480M series devices makes them a nice fit in many applications where the 2-V to 2.5-V dropout of LM78Lxx series devices precludes their (LM78Lxx series devices) use.

The XB3480M series also features a 3.3-V member. The SOT-23 packaging and quasi-low dropout features of the XB3480M series converge in this device to provide a very nice, very tiny, 3.3-V, 100-mA bias supply that regulates directly off the system 5-V  $\pm 5\%$  power supply.

### Device Information<sup>(1)</sup>

PART NUMBER	PACKAGE	BODY SIZE (NOM)
XB3480M	SOT-23 (3)	2.92 mm $\times$ 1.30 mm

(1) For all available packages, see the orderable addendum at the end of the data sheet.

### Typical Application Circuit

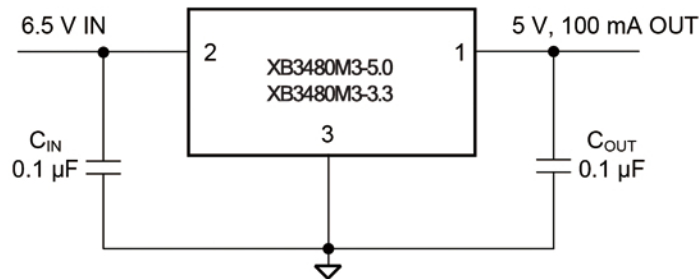

## 4 Pin Configuration and Functions

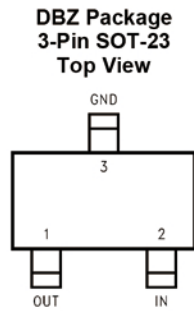

### Pin Functions

PIN		I/O	DESCRIPTION
NAME	NO.		
OUT	1	O	Output voltage
IN	2	I	Input voltage supply
GND	3	—	Common ground

## 5 Specifications

### Absolute Maximum Ratings<sup>(1)(2)</sup>

	MIN	MAX	UNIT
Input voltage (IN to GND)	-0.3	35	V
Power dissipation <sup>(3)</sup>		Internally Limited	
Junction temperature <sup>(3)</sup>	-40	150	°C
Storage temperature, T <sub>stg</sub>	-65	150	°C

- (1) *Absolute Maximum Ratings* are limits beyond which damage to the device may occur. *Recommended Operating Conditions* are conditions under which operation of the device is ensured. Recommended operating ratings do not imply ensured performance limits. For ensured performance limits and associated test conditions, see the [Electrical Characteristics: XB3480M-3.3, XB3480M-5.0](#).
- (2) If Military- or Aerospace-specified devices are required, please contact the TI Sales Office/Distributors for availability and specifications.
- (3) The Absolute Maximum power dissipation depends on the ambient temperature and can be calculated using  $P = (T_J - T_A) / R_{\theta JA}$  where  $T_J$  is the junction temperature,  $T_A$  is the ambient temperature, and  $R_{\theta JA}$  is the junction-to-ambient thermal resistance. The 370-mW rating results from substituting the Absolute Maximum junction temperature, 150°C for  $T_J$ , 50°C for  $T_A$ , and 269.6°C/W for  $R_{\theta JA}$ . More power can be safely dissipated at lower ambient temperatures. Less power can be safely dissipated at higher ambient temperatures. The Absolute Maximum power dissipation can be increased by 3.7 mW for each °C below 50°C ambient. It must be derated by 3.7 mW for each °C above 50°C ambient. Heat sinking enables the safe dissipation of more power. The XB3480 actively limits its junction temperature to about 150°C.

### ESD Ratings

		VALUE	UNIT
V <sub>(ESD)</sub>	Electrostatic discharge	Human-body model (HBM), per ANSI/ESDA/JEDEC JS-001 <sup>(1)</sup>	V
		Charged-device model (CDM), per JEDEC specification JESD22-C101 <sup>(2)</sup>	

- (1) JEDEC document JEP155 states that 500-V HBM allows safe manufacturing with a standard ESD control process.
- (2) JEDEC document JEP157 states that 250-V CDM allows safe manufacturing with a standard ESD control process.

### Recommended Operating Conditions

over operating free-air temperature range (unless otherwise noted)<sup>(1)</sup>

	MIN	MAX	UNIT
Maximum input voltage (IN to GND)	0	30	V
Junction temperature (T <sub>J</sub> )	-40	125	°C

- (1) *Absolute Maximum Ratings* are limits beyond which damage to the device may occur. *Recommended Operating Conditions* are conditions under which operation of the device is ensured. Recommended operating ratings do not imply ensured performance limits. For ensured performance limits and associated test conditions, see the [Electrical Characteristics: XB3480M-3.3, XB3480M-5.0](#).

### Thermal Information

THERMAL METRIC <sup>(1)</sup>		XB3480M	UNIT
		SOT-23 (DBZ)	
		3 PINS	
R <sub>θJA</sub>	Junction-to-ambient thermal resistance	269.6	°C/W
R <sub>θJC(top)</sub>	Junction-to-case (top) thermal resistance	141.1	
R <sub>θJB</sub>	Junction-to-board thermal resistance	63.1	
ψ <sub>JT</sub>	Junction-to-top characterization parameter	24.2	
ψ <sub>JB</sub>	Junction-to-board characterization parameter	62.1	

- (1) For more information about traditional and new thermal metrics, see the *IC Package Thermal Metrics* application report, [SPRA953](#).

**Electrical Characteristics: XB3480M-3.3, XB3480M-5.0**

Typical and other limits apply for  $T_A = T_J = 25^\circ\text{C}$ , unless otherwise specified. Nominal output voltage ( $V_{\text{NOM}}$ ) = 3.3 V or 5 V. <sup>(1)(2)(3)</sup>

PARAMETER	TEST CONDITIONS	$V_{\text{NOM}} = 3.3 \text{ V}$			$V_{\text{NOM}} = 5 \text{ V}$			UNIT
		MIN	TYP	MAX	MIN	TYP	MAX	
$V_{\text{OUT}}$ Output voltage	$V_{\text{IN}} = V_{\text{NOM}} + 1.5 \text{ V}$ $1 \text{ mA} \leq I_{\text{OUT}} \leq 100 \text{ mA}$	3.17	3.3	3.43	4.8	5	5.2	V
	$V_{\text{IN}} = V_{\text{NOM}} + 1.5 \text{ V}$ $1 \text{ mA} \leq I_{\text{OUT}} \leq 100 \text{ mA}$ $-40^\circ\text{C} \leq T_J \leq 125^\circ\text{C}$	3.14		3.46	4.75		5.25	
$\Delta V_{\text{OUT}}$ Line regulation	$V_{\text{NOM}} + 1.5 \text{ V} \leq V_{\text{IN}} \leq 30 \text{ V}$ $I_{\text{OUT}} = 1 \text{ mA}$		10			12		mV
	$V_{\text{NOM}} + 1.5 \text{ V} \leq V_{\text{IN}} \leq 30 \text{ V}$ $I_{\text{OUT}} = 1 \text{ mA}$ $-40^\circ\text{C} \leq T_J \leq 125^\circ\text{C}$			25			25	
$\Delta V_{\text{OUT}}$ Load regulation	$V_{\text{IN}} = V_{\text{NOM}} + 1.5 \text{ V}$ $10 \text{ mA} \leq I_{\text{OUT}} \leq 100 \text{ mA}$		20			20		mV
	$V_{\text{IN}} = V_{\text{NOM}} + 1.5 \text{ V}$ $10 \text{ mA} \leq I_{\text{OUT}} \leq 100 \text{ m}$ $-40^\circ\text{C} \leq T_J \leq 125^\circ\text{C}$			40			40	
$I_{\text{GND}}$ Ground pin current	$V_{\text{NOM}} + 1.5 \text{ V} \leq V_{\text{IN}} \leq 30 \text{ V}$ No Load		2			2		mA
	$V_{\text{NOM}} + 1.5 \text{ V} \leq V_{\text{IN}} \leq 30 \text{ V}$ No Load, $-40^\circ\text{C} \leq T_J \leq 125^\circ\text{C}$			4			4	
$V_{\text{IN}} - V_{\text{OUT}}$ Dropout voltage	$I_{\text{OUT}} = 10 \text{ mA}$		0.7	0.9		0.7	0.9	V
	$I_{\text{OUT}} = 10 \text{ mA}$ $-40^\circ\text{C} \leq T_J \leq 125^\circ\text{C}$			1			1	
	$I_{\text{OUT}} = 100 \text{ mA}$		0.9	1.1		0.9	1.1	V
	$I_{\text{OUT}} = 100 \text{ mA}$ $-40^\circ\text{C} \leq T_J \leq 125^\circ\text{C}$			1.2			1.2	
$e_n$ Output noise voltage	$V_{\text{IN}} = 10 \text{ V}$ Bandwidth: 10 Hz to 100 kHz		100			150		$\mu\text{V}_{\text{rms}}$

- (1) A typical is the center of characterization data taken with  $T_A = T_J = 25^\circ\text{C}$ . Typical are not ensured.
- (2) All limits are ensured. All electrical characteristics having room-temperature limits are tested during production with  $T_A = T_J = 25^\circ\text{C}$ . All hot and cold limits are ensured by correlating the electrical characteristics to process and temperature variations and applying statistical process control.
- (3) All voltages except dropout are with respect to the voltage at the GND pin.

**Electrical Characteristics: XB3480M-12, XB3480M-15**

Typical and other limits apply for  $T_A = T_J = 25^\circ\text{C}$ , unless otherwise specified. Nominal output voltage ( $V_{\text{NOM}}$ ) = 12 V or 15 V.  
 $V_{\text{IN}}$  (1)(2)(3)

PARAMETER	TEST CONDITIONS	$V_{\text{NOM}} = 12 \text{ V}$			$V_{\text{NOM}} = 15 \text{ V}$			UNIT
		MIN	TYP	MAX	MIN	TYP	MAX	
$V_{\text{OUT}}$	Output voltage $V_{\text{IN}} = V_{\text{NOM}} + 1.5 \text{ V}$ $1 \text{ mA} \leq I_{\text{OUT}} \leq 100 \text{ mA}$	11.52	12	12.48	14.4	15	15.6	V
		11.4		12.6	14.25		15.75	
$\Delta V_{\text{OUT}}$	Line regulation $V_{\text{NOM}} + 1.5 \text{ V} \leq V_{\text{IN}} \leq 30 \text{ V}$ $I_{\text{OUT}} = 1 \text{ mA}$	14			16			mV
				40			40	
$\Delta V_{\text{OUT}}$	Load regulation $V_{\text{IN}} = V_{\text{NOM}} + 1.5 \text{ V}$ $10 \text{ mA} \leq I_{\text{OUT}} \leq 100 \text{ mA}$	36			45			mV
				60			75	
$I_{\text{GND}}$	Ground pin current $V_{\text{NOM}} + 1.5 \text{ V} \leq V_{\text{IN}} \leq 30 \text{ V}$ No Load	2			2			mA
				4			4	
$V_{\text{IN}} - V_{\text{OUT}}$	Dropout voltage $I_{\text{OUT}} = 10 \text{ mA}$	0.7	0.9		0.7	0.9		V
				1			1	
		0.9	1.1		0.9	1.1		V
				1.2			1.2	
$e_n$	Output noise voltage $V_{\text{IN}} = 10 \text{ V}$ Bandwidth: 10 Hz to 100 kHz	360			450			$\mu\text{V}_{\text{rms}}$

- (1) A typical is the center of characterization data taken with  $T_A = T_J = 25^\circ\text{C}$ . Typical values are not ensured.
- (2) All limits are ensured. All electrical characteristics having room-temperature limits are tested during production with  $T_A = T_J = 25^\circ\text{C}$ . All hot and cold limits are ensured by correlating the electrical characteristics to process and temperature variations and applying statistical process control.
- (3) All voltages except dropout are with respect to the voltage at the GND pin.

**Typical Characteristics**

Unless indicated otherwise,  $V_{IN} = V_{NOM} + 1.5\text{ V}$ ,  $C_{IN} = 0.1\ \mu\text{F}$ ,  $C_{OUT} = 0.1\ \mu\text{F}$ , and  $T_A = 25^\circ\text{C}$ .

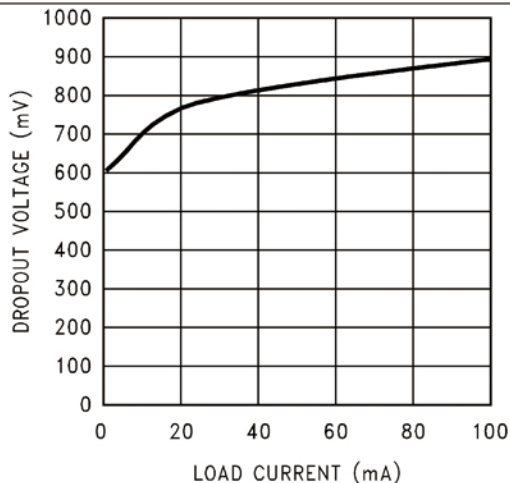

**Figure 1. Dropout Voltage vs Load Current**

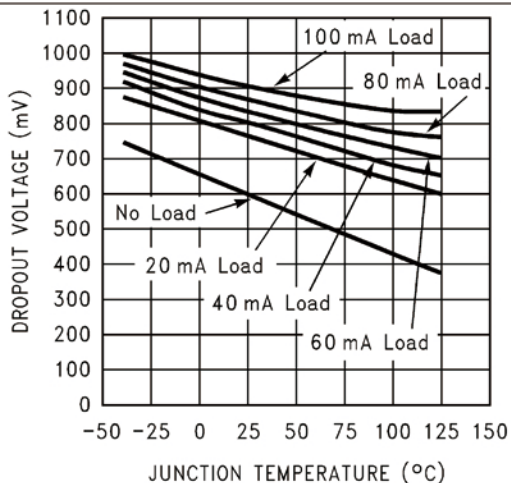

**Figure 2. Dropout Voltage vs Junction Temperature**

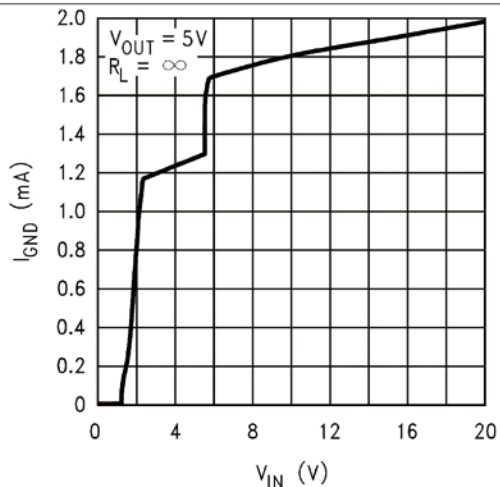

**Figure 3. Ground Pin Current vs Input Voltage**

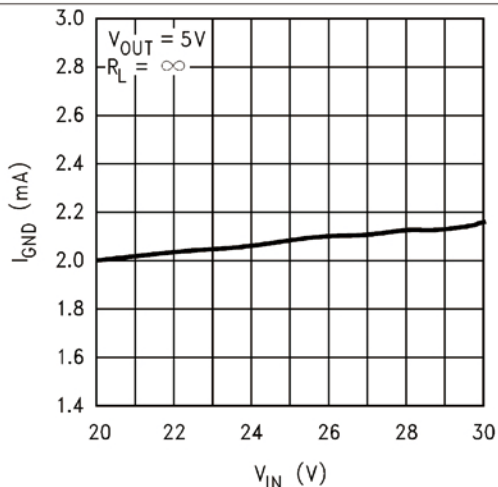

**Figure 4. Ground Pin Current vs Input Voltage**

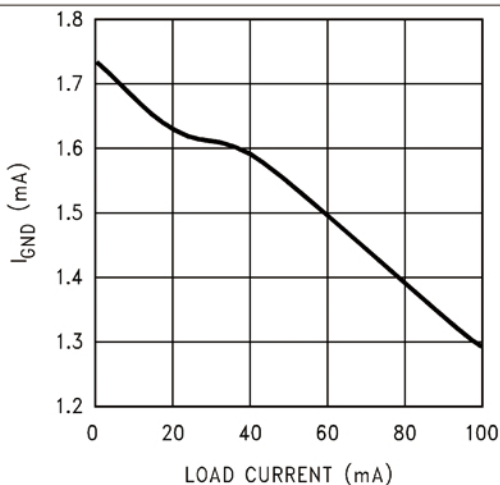

**Figure 5. Ground Pin Current vs Load Current**

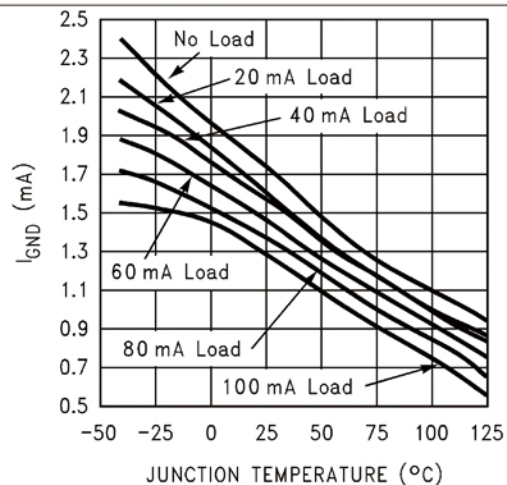

**Figure 6. Ground Pin Current vs Junction Temperature**

**Typical Characteristics (continued)**

Unless indicated otherwise,  $V_{IN} = V_{NOM} + 1.5\text{ V}$ ,  $C_{IN} = 0.1\ \mu\text{F}$ ,  $C_{OUT} = 0.1\ \mu\text{F}$ , and  $T_A = 25^\circ\text{C}$ .

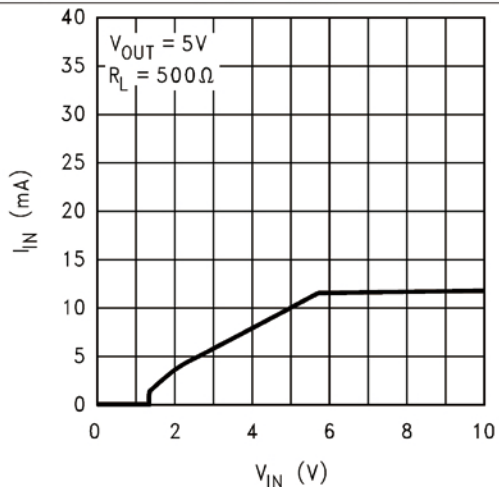

**Figure 7. Input Current vs Input Voltage**

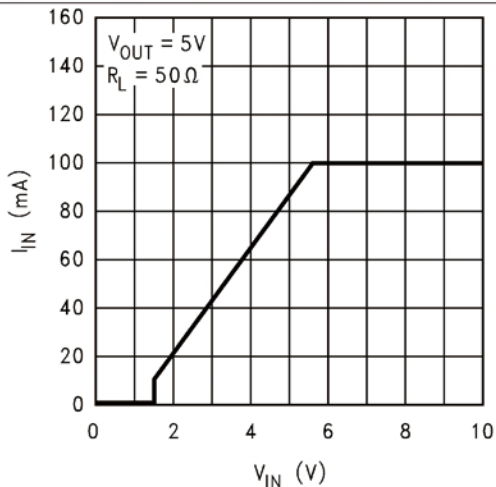

**Figure 8. Input Current vs Input Voltage**

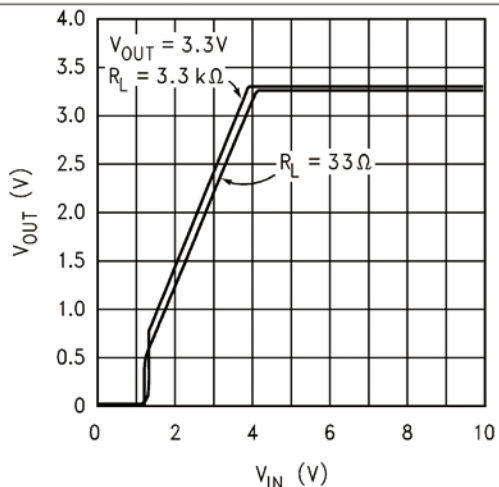

**Figure 9. Output Voltage vs Input Voltage**

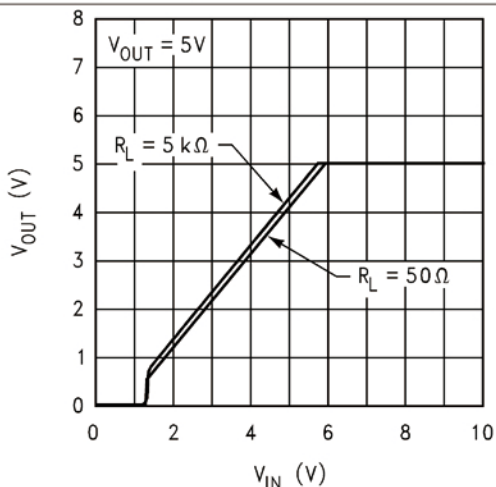

**Figure 10. Output Voltage vs Input Voltage**

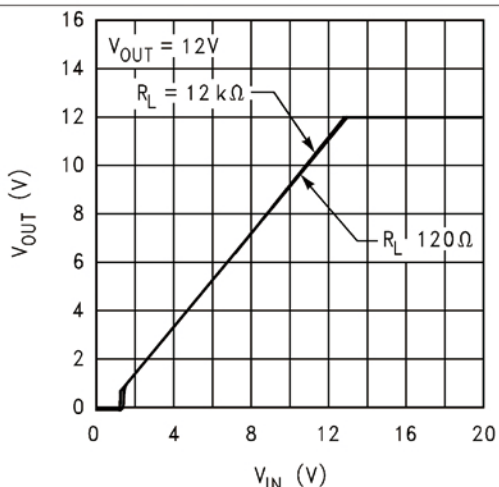

**Figure 11. Output Voltage vs Input Voltage**

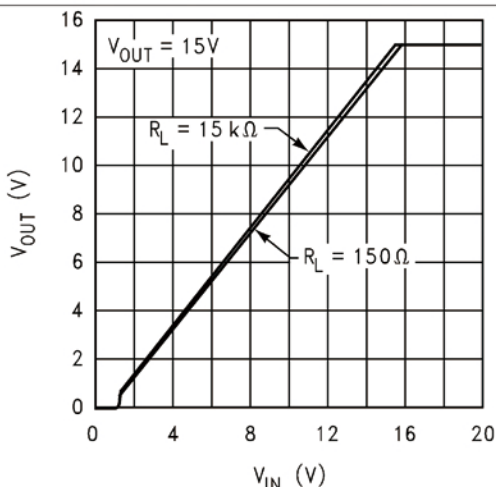

**Figure 12. Output Voltage vs Input Voltage**

**Typical Characteristics (continued)**

Unless indicated otherwise,  $V_{IN} = V_{NOM} + 1.5\text{ V}$ ,  $C_{IN} = 0.1\ \mu\text{F}$ ,  $C_{OUT} = 0.1\ \mu\text{F}$ , and  $T_A = 25^\circ\text{C}$ .

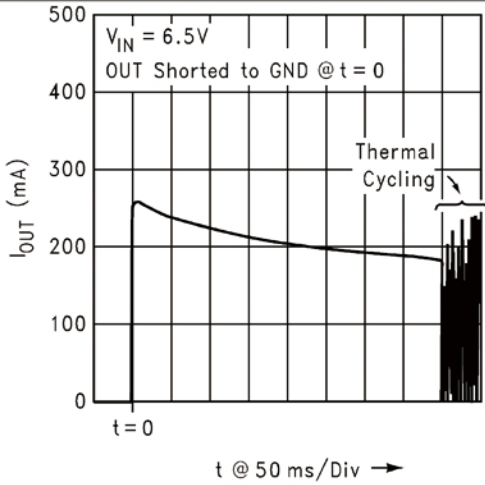

**Figure 13. Output Short-Circuit Current**

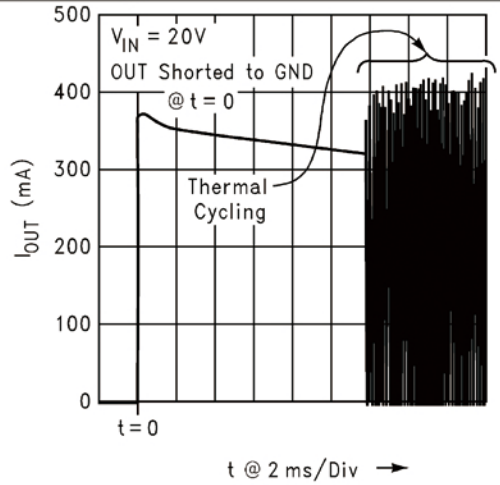

**Figure 14. Output Short-Circuit Current**

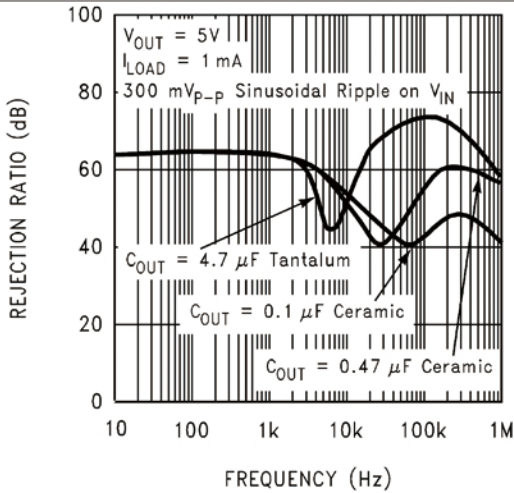

**Figure 15. Power Supply Rejection Ratio**

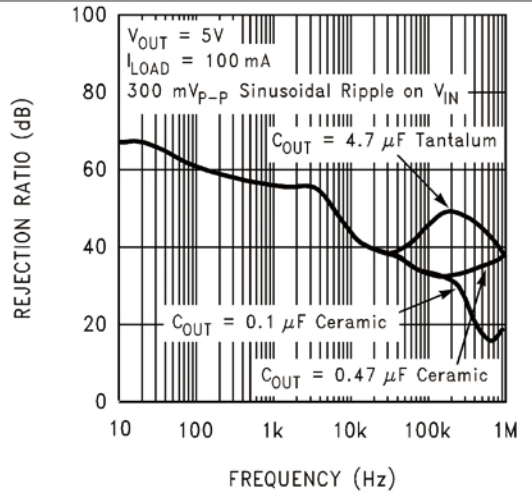

**Figure 16. Power Supply Rejection Ratio**

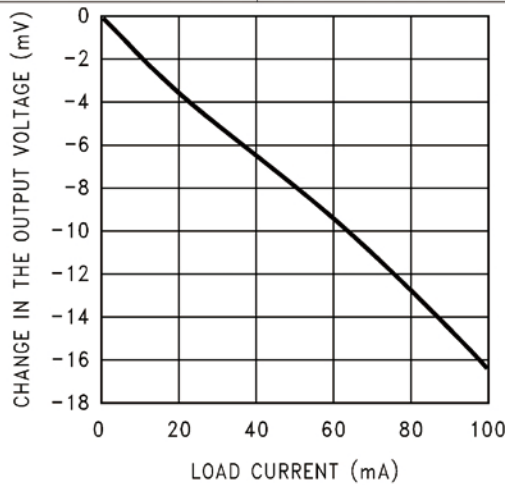

**Figure 17. DC Load Regulation**



## 6 Detailed Description

### Overview

The XB3480M is an integrated linear voltage regulator with inputs that can be as high as 30 V. It ensures a maximum dropout of 1.2 V at the full load of 100 mA. The XB3480M has different output options including 3.3-V, 5-V, 12-V, and 15-V outputs, making XB3480M the tiny alternative to industry standard LM78Lxx series and similar devices.

### Functional Block Diagram

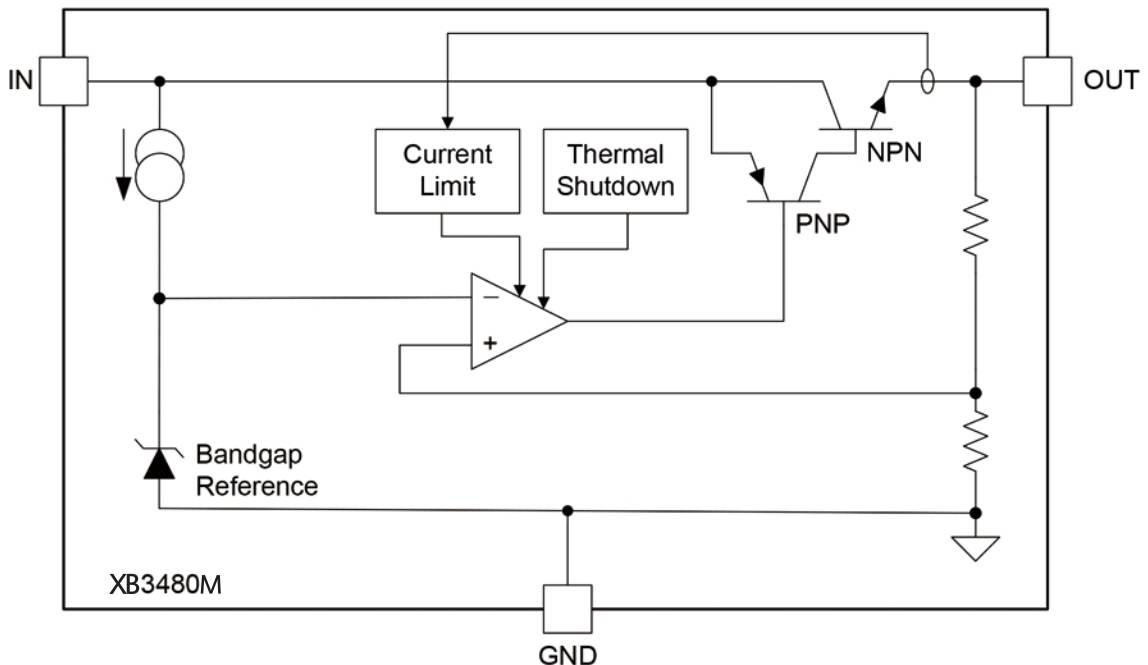

### Feature Description

#### 3.3-V, 5-V, 12-V, and 15-V Versions Available

The 3.3-V, 5-V, 12-V, and 15-V versions of XB3480M series are intended as tiny alternatives to industry standard LM78Lxx series and similar devices.

#### 1.2-V Ensured Maximum Dropout

The 1.2-V quasi-low dropout of the XB3480M series devices make them a nice fit in many application where the 2-V to 2.5-V dropout of LM78Lxx series devices precludes their use.

### Device Functional Modes

#### Operation with $V_{IN} = 5\text{ V}$

The 3.3-V member of XB3480M can operate with an input of  $5\text{ V} \pm 5\%$ , its tiny SOT-23 package and quasi-low dropout makes it suitable for providing a very tiny, 3.3-V, 100-mA bias supply from 5-V power supply.

## 7 Application and Implementation

### NOTE

Information in the following applications sections is not part of the TI component specification, and TI does not warrant its accuracy or completeness. TI's customers are responsible for determining suitability of components for their purposes. Customers should validate and test their design implementation to confirm system functionality.

### Application Information

The XB3480M is a linear voltage regulator with 1.2-V ensured maximum dropout and 100-mA ensured minimum load current. This device has 3.3-V, 5-V, 12-V, and 15-V versions. The implementation of XB3480M is discussed in this section.

### Typical Application

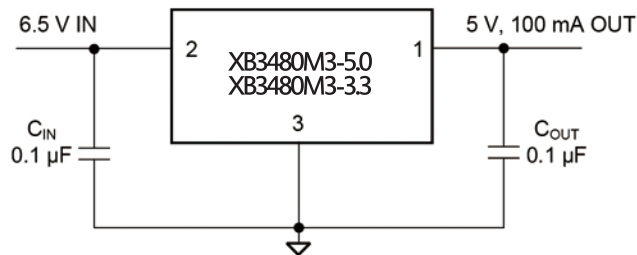

### Design Requirements

DESIGN PARAMETER	EXAMPLE VALUE
Input voltage	6.5 V
Output voltage	5 V
Output current	100 mA

### Detailed Design Procedure

#### External Capacitors

A minimum input and output capacitance value of 0.1  $\mu\text{F}$  is required for stability and adequate transient performance. There is no specific ESR limitation, although excessively high ESR will compromise transient performance. There is no specific limitation on a maximum capacitance value on the input or the output.

#### Output Capacitor

The minimum output capacitance required to maintain stability is 0.1  $\mu\text{F}$ . Larger values of output capacitance can be used to improve transient behavior.

#### Application Curves

Unless indicated otherwise,  $V_{\text{IN}} = 6.5 \text{ V}$ ,  $V_{\text{OUT}} = 5 \text{ V}$ ,  $C_{\text{OUT}} = 0.1 \mu\text{F}$ , and  $T_{\text{A}} = 25^\circ\text{C}$

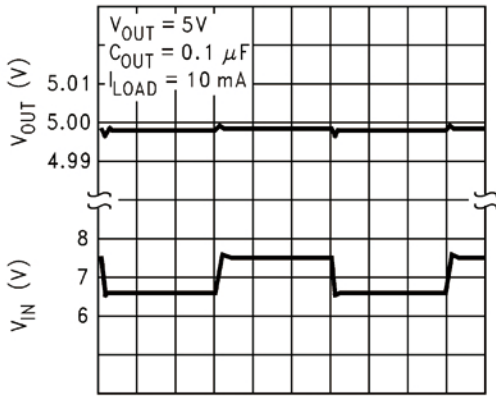

200  $\mu$ s/Div

**Figure 18. Line Transient Response**

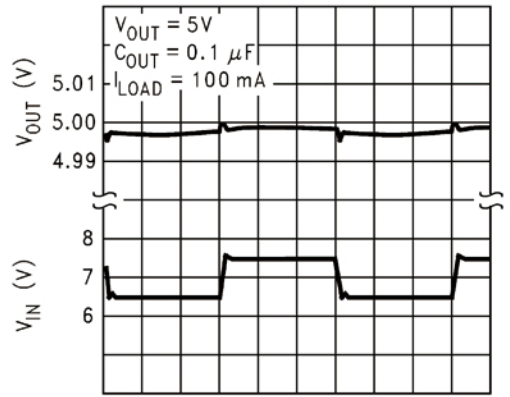

200  $\mu$ s/Div

**Figure 19. Line Transient Response**

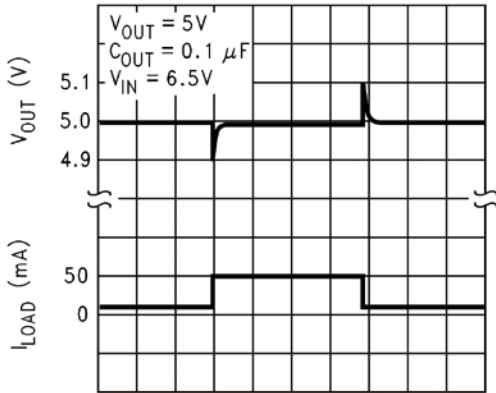

50  $\mu$ s/Div

**Figure 20. Load Transient Response**

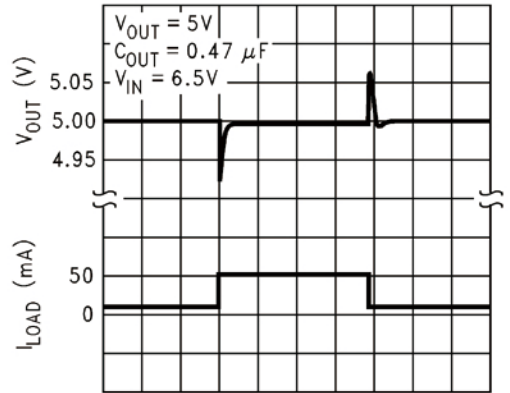

50  $\mu$ s/Div

**Figure 21. Load Transient Response**

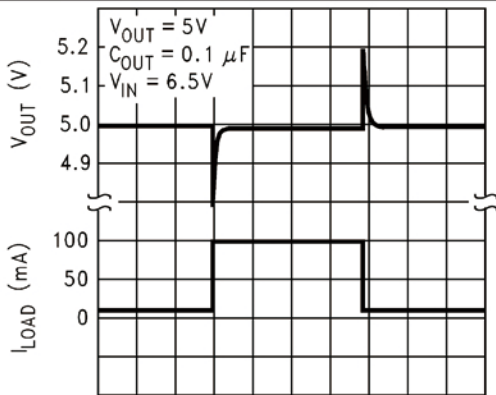

50  $\mu$ s/Div

**Figure 22. Load Transient Response**

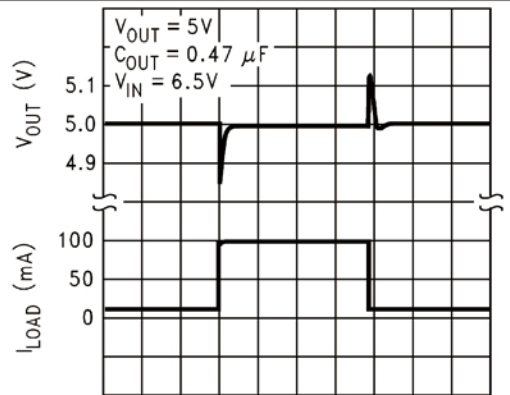

50  $\mu$ s/Div

**Figure 23. Load Transient Response**

## 8 Power Supply Recommendations

The XB3480M is designed to be operated from up to a 30-V input voltage supply. This input supply must be well regulated. If the input supply is noisy, additional input capacitors with low ESR can help to improve the output noise performance.

## 9 Layout

### Layout Guidelines

For best overall performance, place all the circuit components on the same side of the circuit board and as near as practical to the respective LDO pin connections. Place ground return connections to the input and output capacitors, and to the LDO ground pin as close to each other as possible, connected by a wide, component-side, copper surface. The use of vias and long traces to create LDO circuit connections is strongly discouraged and negatively affects system performance. This grounding and layout scheme minimizes the inductive parasitic, and thereby reduces load-current transients, minimizes noise, and increases circuit stability.

A ground reference plane is also recommended and is either embedded in the PCB itself or located on the bottom side of the PCB opposite the components. This reference plane serves to assure accuracy of the output voltage, shield noise, and behaves similar to a thermal plane to spread heat from the LDO device. In most applications, this ground plane is necessary to meet thermal requirements.

### Layout Example

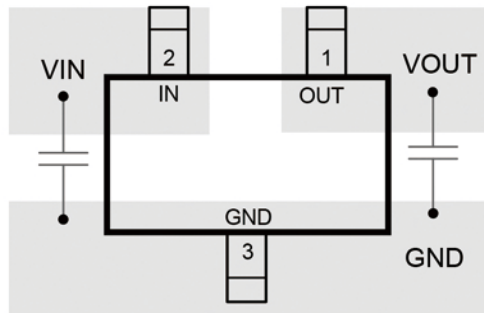

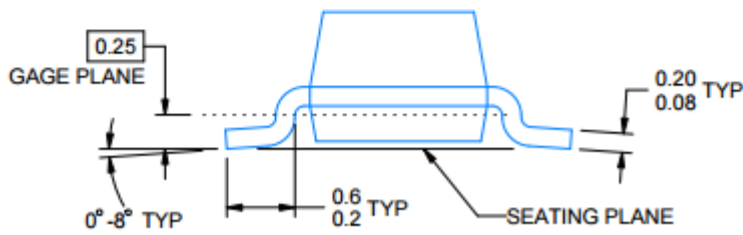
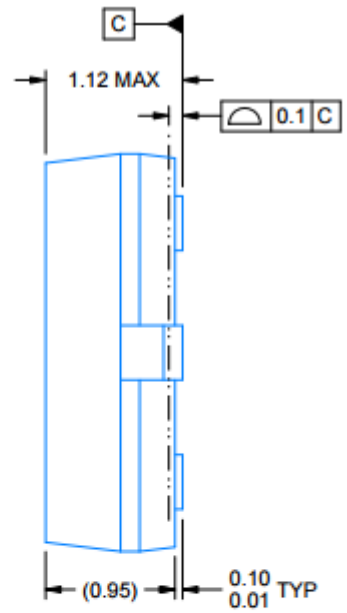
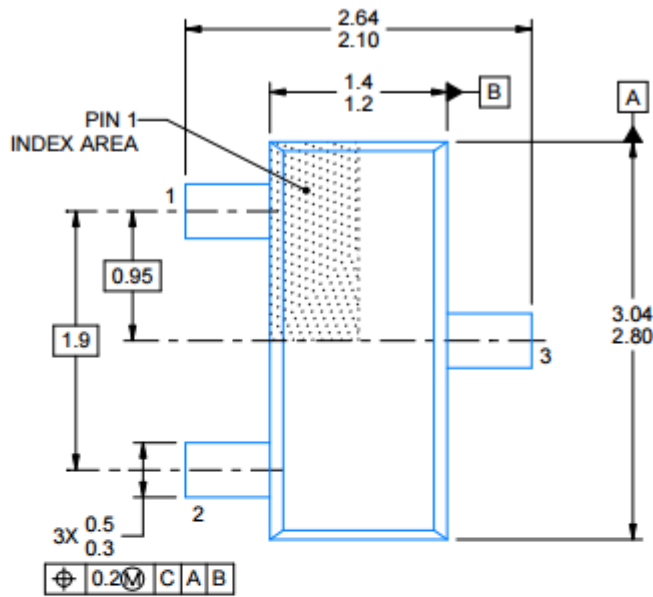

以上信息仅供参考. 如需帮助联系客服人员。谢谢 XINLUDA