

PTS645 Series 6 mm Tact Switches

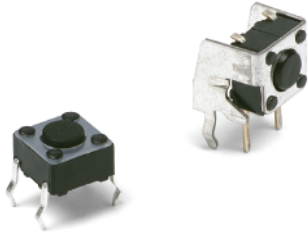

Features/Benefits

- Compact size 6 x 6 mm
- Variety of actuator lengths
- Choice of actuation force
- RoHS compliant and compatible

Typical Applications

- Consumer products
- Instrumentation
- Computer products
- Industrial

B

Tactile Switches

Specification

FUNCTION: Momentary action
CONTACT ARRANGEMENT: SPST, N.O.
TERMINALS: PC pins

Mechanical

ACTUATION FORCE: 130 grams, 160 grams, 200 grams, 260 grams
LIFE EXPECTANCY: 100,000 operations.

Electrical

CONTACT RATING: 50 mA @ 12 V DC.
DIELECTRIC STRENGTH: 250 V AC min.
CONTACT RESISTANCE: 100 mΩ max. initial.
INSULATION RESISTANCE: 10¹¹ Ω min.

Environmental

OPERATING TEMPERATURE: -20°C to 60°C

Process

SOLDERING: Preheating to 100°C for 45 sec. max. Keep flux flush with top surface of PCB; do not apply to component side of PCB and area where terminals are located. Soldering to 255°C for 5 sec. max. Clean by brushing on solder surface. Do not clean switch with solvents.

Packaging

Bulk packaging.

Tape & reel for the SMT type:

Reels of 1,000 pieces for 4,3 and 5,0 mm height
Reels of 700 pieces for 7,0 mm height
Reels of 500 pieces for 9,5 mm height
Reels of 400 pieces for 13,0 mm height

NOTE: Specifications listed above are for switches with standard options.
For information on specific and custom switches, consult Customer Service Center.

How To Order

Our easy build-a-switch concept allows you to mix and match options to create the switch you need. To order, select desired option from each category and place it in the appropriate box.

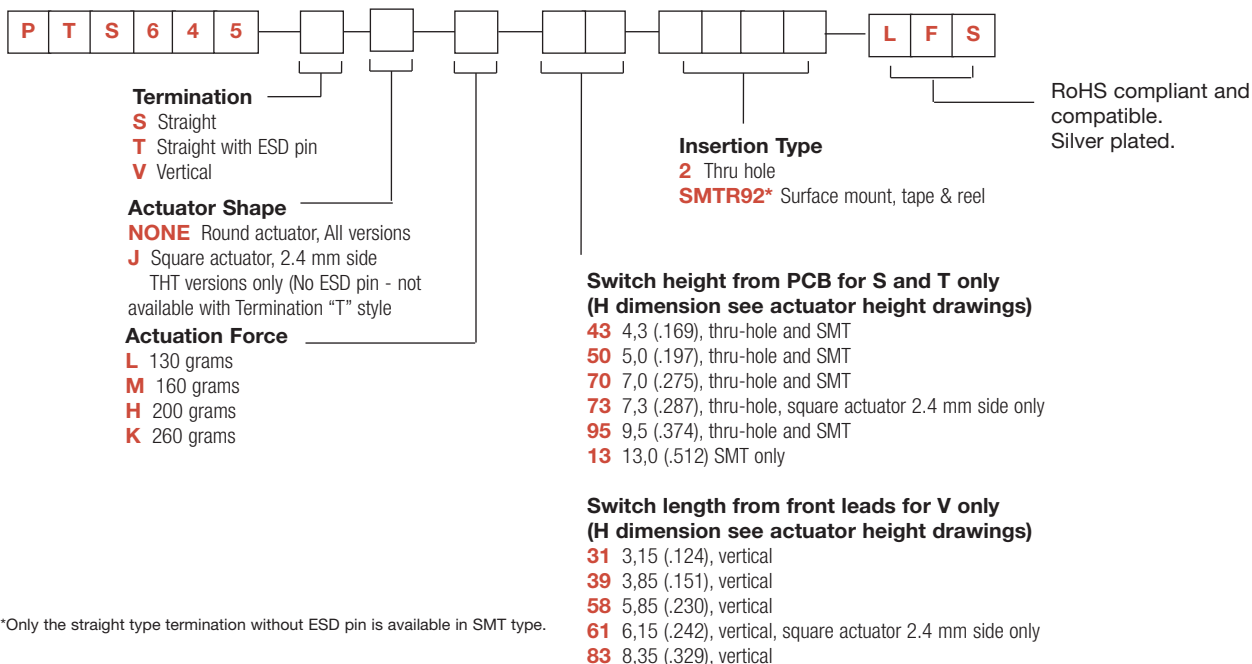

*Only the straight type termination without ESD pin is available in SMT type.



Dimensions are shown: mm
Specifications and dimensions subject to change

PTS645 Series 6 mm Tact Switches

TERMINATION

S STRAIGHT

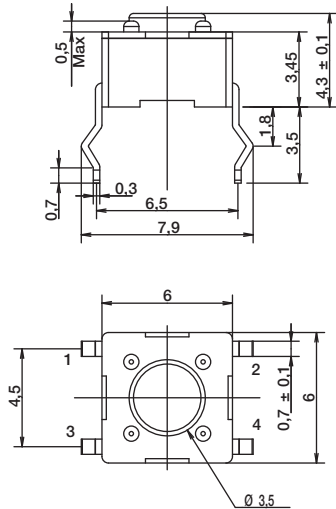

SCHEMATIC

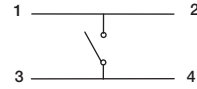

PCB LAYOUT

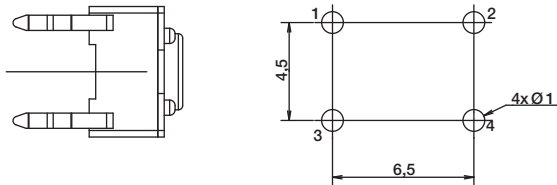

T STRAIGHT WITH ESD PIN

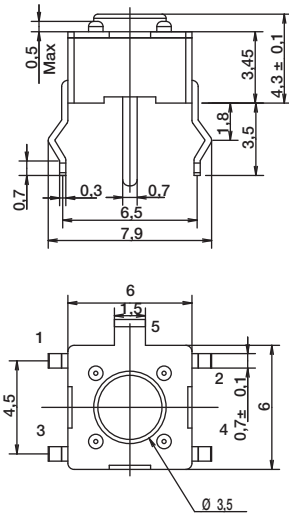

SCHEMATIC

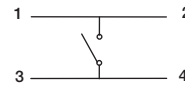

PCB LAYOUT

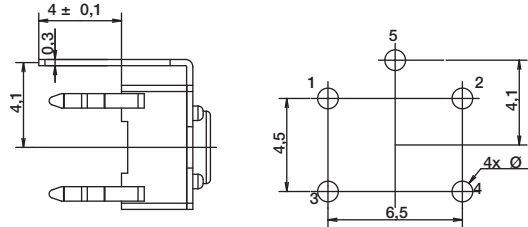

V VERTICAL

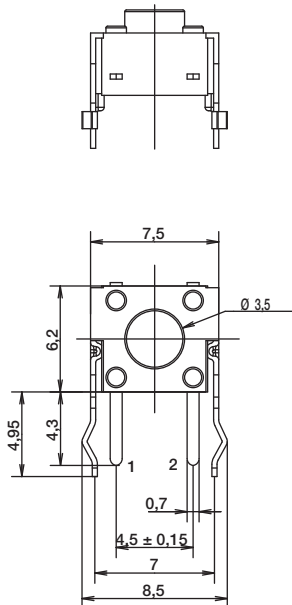

SCHEMATIC

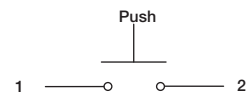

PCB LAYOUT

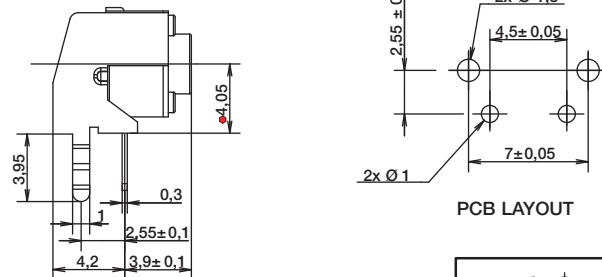

Dimensions are shown: mm
Specifications and dimensions subject to change

PTS645 Series 6 mm Tact Switches

TERMINATION

SMT

FOR 4.3, 5.0, 7.0, 9.5 MM HEIGHT

13.0 MM HEIGHT ONLY

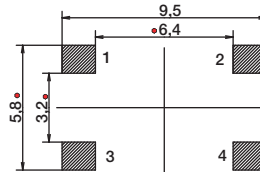
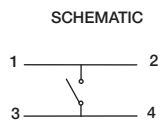
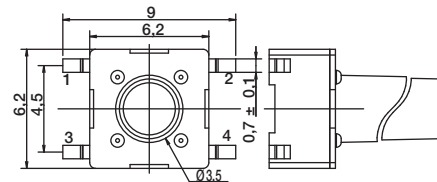
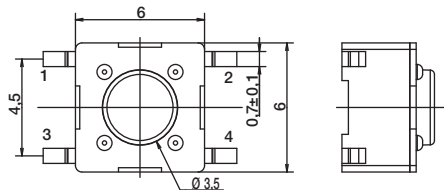
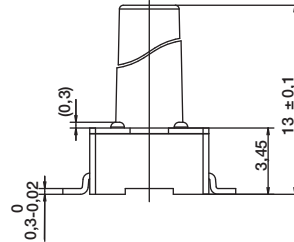
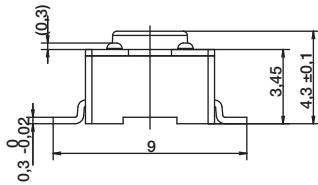

PCB LAYOUT

ACTUATOR SHAPE

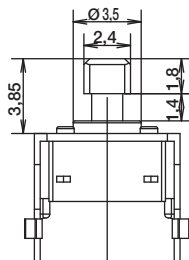

SCHEMATIC

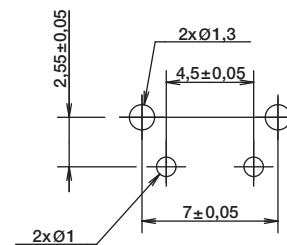
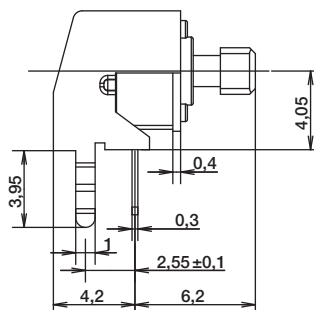
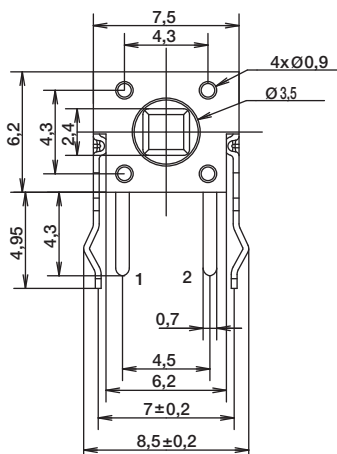
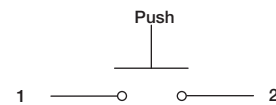

RECOMMENDED PCB LAYOUT



First Angle
Projection

Dimensions are shown: mm
Specifications and dimensions subject to change

PTS645 Series 6 mm Tact Switches

ACTUATOR SHAPE

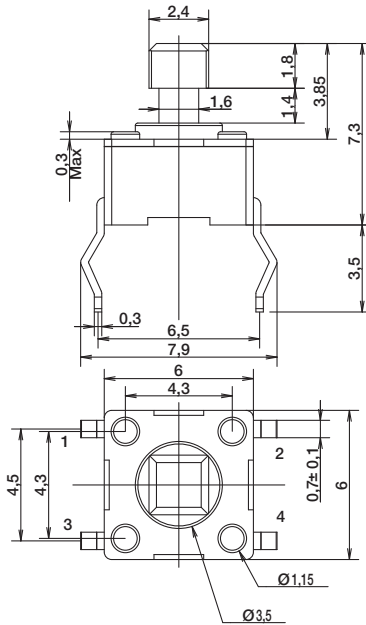

SCHEMATIC

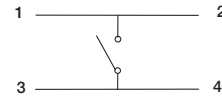

RECOMMENDED PCB LAYOUT

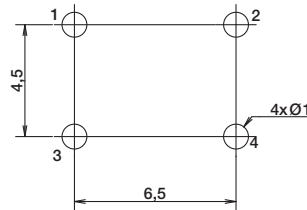

B

Tactile Switches

ACTUATION FORCE

OPTION CODE	FORCE
L	130 grams Black
M	160 grams Blue
H	200 grams Gray
K	260 grams Red

ACTUATOR HEIGHT

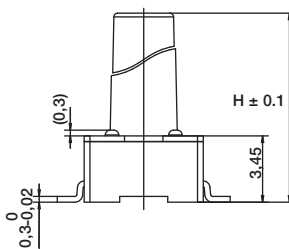

Switch height from PCB for S and T only

OPTION CODE	DIMENSION H	TERMINATION	SCHEMATIC	
			Without EMC pin	With EMC pin
43	4,3 (.169)	Thru-hole and SMT		
50	5,0 (.197)	Thru-hole and SMT		
70	7,0 (.275)	Thru-hole and SMT		
95	9,5 (.374)	Thru-hole and SMT		
13	13,0 (.512)	SMT		

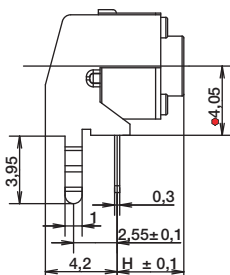

Switch length from front leads for V only

OPTION CODE	DIMENSION H	TERMINATION	SCHEMATIC	
			Without EMC pin	With EMC pin
31	3,15 (.124)	Vertical		
39	3,85 (.151)	Vertical		
58	5,85 (.230)	Vertical		
83	8,35 (.329)	Vertical		

PTS645 Series 6 mm Tact Switches

TAPE & REEL

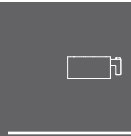

B

Tactile Switches

