

■ **Features**

- High Luminous LEDs
- 3mm Round Standard Directivity
- UV Resistant Epoxy
- Integral Current Limiting Resistor
- TTL Compatible (Requires No External Current Limiter With 5 Volt Supply)
- Cost Effective (Saves Space and Resistor Cost)
- Color Diffused Type

■ **Applications**

- Status Indicators
- Other Lighting

■ **Outline Dimension**

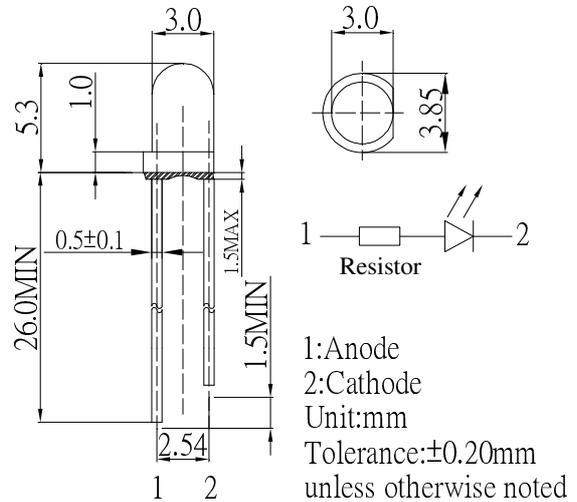

■ **Absolute Maximum Rating**

(Ta=25°C)

Item	Symbol	Value	Unit
DC Forward Voltage	V _F	7.5	V
Reverse Voltage	V _R	5	V
Power Dissipation	P _D	150	mW
Operating Temperature	T _{opr}	-30 ~ +85	°C
Storage Temperature	T _{stg}	-40 ~ +100	°C
Lead Soldering Temperature	T _{sol}	260°C/5sec	-

■ **Directivity**

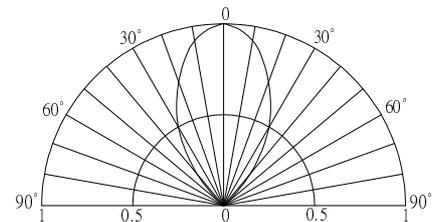

■ **Electrical -Optical Characteristics**

(Ta=25°C)

Item	Symbol	Condition	Min.	Typ.	Max.	Unit
DC Forward Current*1	I _F	V _F =5V	-	12	20	mA
DC Reverse Current	I _R	V _R =5V	-	-	10	μA
Domi. Wavelength*2	λ _D	V _F =5V	565	570	575	nm
Luminous Intensity*3	I _v	V _F =5V	30	45		mcd
50% Power Angle	2θ _{1/2}	V _F =5V	-	60	-	deg

*1 Tolerance of measurements of forward current is ±1mA

*2 Tolerance of measurements of dominant wavelength is ±1nm

*3 Tolerance of measurements of luminous intensity is ±15%