

# MAX2181

# FM Automotive Low-Noise Amplifier

## General Description

The MAX2181 is a highly integrated FM variable-gain low-noise amplifier ideal for use in automotive FM and FM-diversity active antenna applications. The device features an FM signal path, providing 30dB of gain range, controlled by an on-chip power detector. The FM signal path covers 76MHz to 162.5MHz.

The device integrates a voltage regulator and pass transistor, allowing operation using battery voltages in the +6V to +24V range. On-chip thermal protection automatically limits junction temperatures during extreme thermal conditions.

The device is available in a small, 3mm x 3mm TQFN package and operates over the extended industrial temperature range (-40°C to +85°C).

## Applications

- Automotive Active Antenna

## Features

- +6V to +24V Supply Voltage Range
- Integrated AGC Function Eliminates External Pin Diodes
- High Dynamic Range
- Low-Noise, Sub 3dB Noise Figure
- Low External BOM
- Integrated Thermal Protection
- Small Package (3mm x 3mm TQFN)
- Integrated Pass Device and Linear Regulator
- Integrated Power Detector
- Integrated Antenna Sense

*Ordering Information appears at end of data sheet.*

*For related parts and recommended products to use with this part, refer to [www.maximintegrated.com/MAX2181.related](http://www.maximintegrated.com/MAX2181.related).*

## Simplified Block Diagram

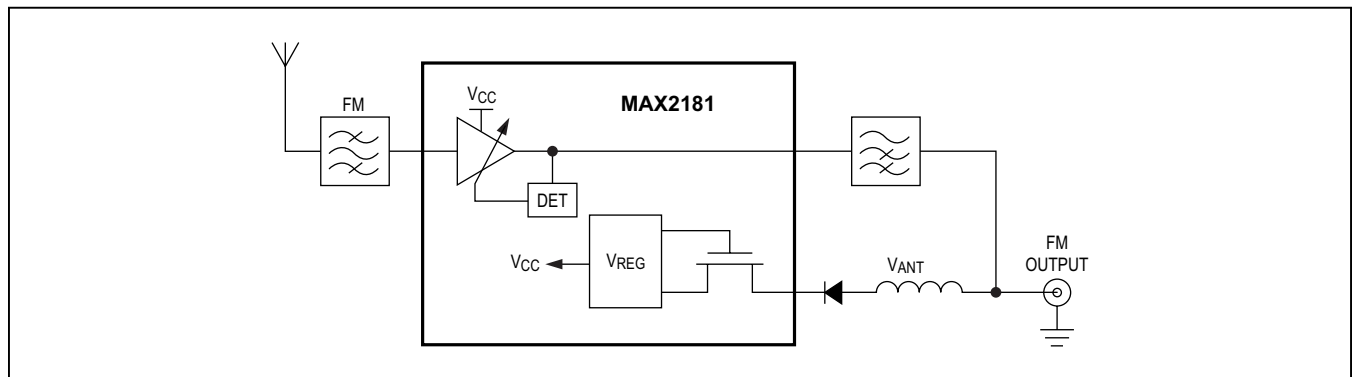

### Absolute Maximum Ratings

V <sub>BATT</sub> .....	-0.5V to +26V	θ <sub>JC</sub> (Junction to Case) (Note 1) .....	7°C/W
LDO .....	-0.5V to +6V	θ <sub>JA</sub> (Junction to Ambient) (Note 1) .....	48°C/W
F <sub>MOUT</sub> .....	-0.5V to V <sub>LDO</sub>	Operating Temperature Range .....	-40°C to +85°C
Short-Circuit Protection F <sub>MOUT</sub> .....	Indefinite	Junction Temperature .....	+150°C
F <sub>MIN</sub> .....	130dBμVRF	Storage Temperature Range .....	-65°C to +165°C
Continuous Power Dissipation (T <sub>A</sub> = +70°C)		Lead Temperature (TQFN only, soldering, 10s) .....	+300°C
(derate 20.8mW/°C above +70°C) .....	1666.7mW	Soldering Temperature (reflow) .....	+260°C

**Note 1:** Package thermal resistances were obtained using the method described in JEDEC specification JESD51-7, using a four-layer board. For detailed information on package thermal considerations, refer to [www.maximintegrated.com/thermal-tutorial](http://www.maximintegrated.com/thermal-tutorial).

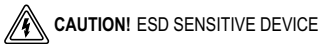

Stresses beyond those listed under "Absolute Maximum Ratings" may cause permanent damage to the device. These are stress ratings only, and functional operation of the device at these or any other conditions beyond those indicated in the operational sections of the specifications is not implied. Exposure to absolute maximum rating conditions for extended periods may affect device reliability.

### DC Electrical Characteristics

(MAX2181 Evaluation Kit as shown, V<sub>BATT</sub> = 8V to 15V, T<sub>A</sub> = -40°C to +85°C, unless otherwise noted. Typical values are at V<sub>BATT</sub> = 10V, T<sub>A</sub> = +25°C.) (Note 2)

PARAMETER	CONDITIONS	MIN	TYP	MAX	UNITS
<b>SUPPLY VOLTAGE (V<sub>BATT</sub>)</b>					
V <sub>BATT</sub>	Operational range	8	10	15	V
	Functional range (Note 3)	15		24	
Voltage Regulation	V <sub>LDO</sub> (Pin 12)		5.1		V
Supply Current	Normal operation (V <sub>ANTSENSE</sub> = 0V or 6V < V <sub>ANTSENSE</sub> = 12V)		56	68	mA
	Antenna fault, ANTSENSE open	15		25	
<b>GAIN CONTROL AND AGC CONTROL (FMDET, FMGAIN, ANTSENSE)</b>					
ANTSENSE	Ground	-50			μA
	Open		2.5		V
	LDO			50	μA
FMDET	Ground	-65			μA
	LDO			50	
FMGAIN	Ground	-50			μA
	Open		2.5		V
	LDO			50	μA

## AC Electrical Characteristics

(MAX2181 Evaluation Kit,  $V_{BATT} = 8V$  to  $15V$ ,  $T_A = -40^{\circ}C$  to  $+85^{\circ}C$ , unless otherwise noted. Typical values are at  $V_{BATT} = 10V$ , load impedance =  $50\Omega$ , FMGAIN connected to ground, tuned for 87MHz to 108MHz,  $T_A = +25^{\circ}C$ .) (Note 2)

PARAMETER	CONDITIONS	MIN	TYP	MAX	UNITS
Frequency Range		76		162.5	MHz
Power Gain Maximum	$f_{IN} = 97MHz$ , FMGAIN connected to $V_{LDO}$	6.0	8.3	10	dB
	$f_{IN} = 97MHz$ , FMGAIN open	5.0	7.2	9.0	
	$f_{IN} = 97MHz$ , FMGAIN connected to ground	4.0	6.0	8.0	
Gain Flatness	76MHz to 90MHz (Notes 4, 5)			0.5	dB
	87MHz to 108MHz (Note 4)			0.5	
	162.5MHz relative to 97MHz			3.2	
Noise Figure	$f_{IN} = 97MHz$ , $T_A = +25^{\circ}C$		2.75		dB
Input Return Loss	$50\Omega$ source		10		dB
Output Return Loss	$50\Omega$ load		15		dB
Gain Control Range	$f_{IN} = 97MHz$	28	32		dB
IMD3	$V_{IN} = +120dB\mu V$ /tone, $+100dB\mu V$ AGC threshold, 99.5MHz and 100.5MHz tones		66		dBc
AGC Threshold	Minimum output threshold		92		dB $\mu V$
	Maximum output threshold		106		
AGC Threshold Variation	Relative to 97MHz tone (76MHz to 108MHz)		1		dB

**Note 2:** Min and max values are production tested at  $T_A = +25^{\circ}C$  and  $+85^{\circ}C$ . Min and Max limits at  $T_A = -40^{\circ}C$  are guaranteed by design and characterization.

**Note 3:** Device automatically reduces current to limit die temperature within a safe range, but otherwise remains functional.

**Note 4:** Guaranteed by design and characterization.

**Note 5:** Tuned for 76MHz to 90MHz.

Typical Operating Characteristics

(MAX2181 Evaluation Kit,  $V_{BATT} = 10V$ , tuned for 87MHz to 108MHz, FMGAIN connected to ground,  $T_A = +25^\circ C$ , unless otherwise noted.)

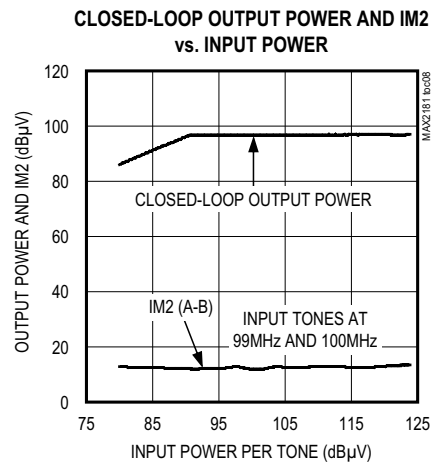
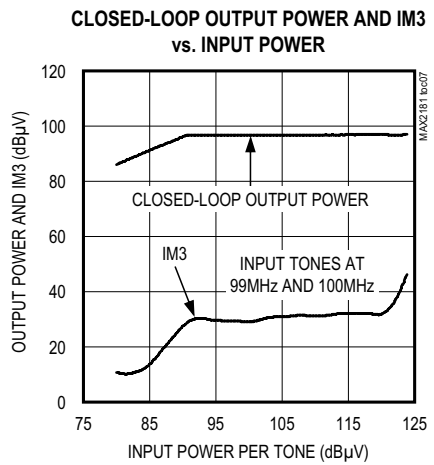
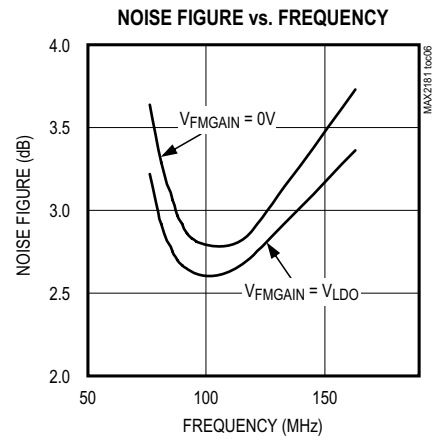
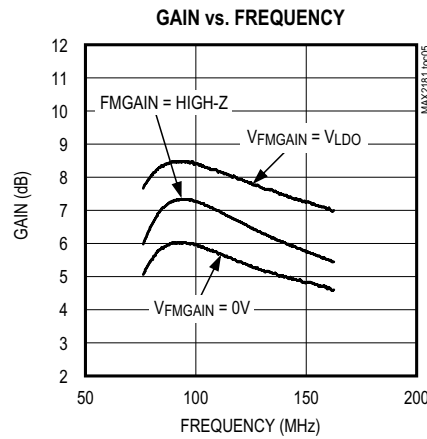
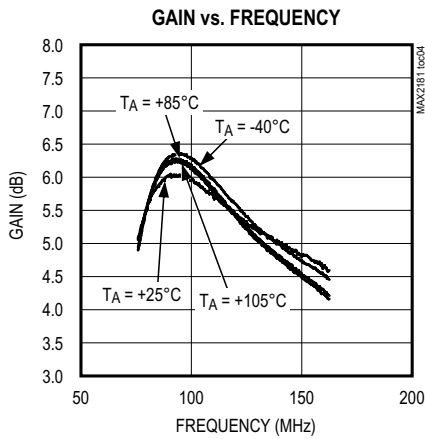
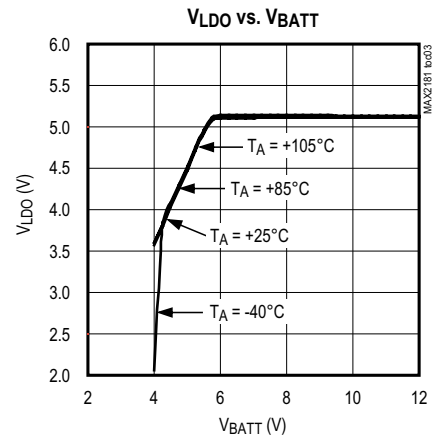
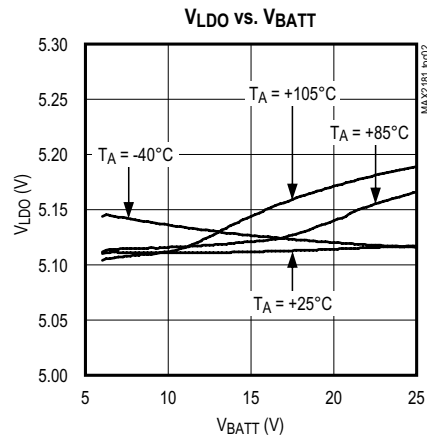
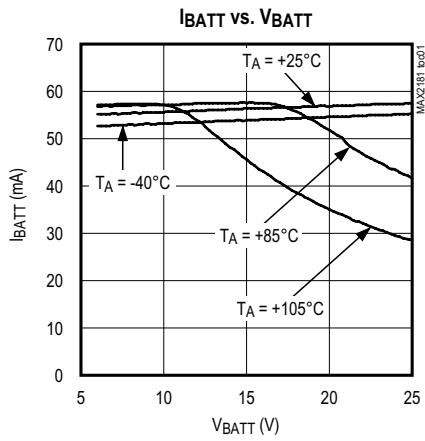

### Pin Configuration

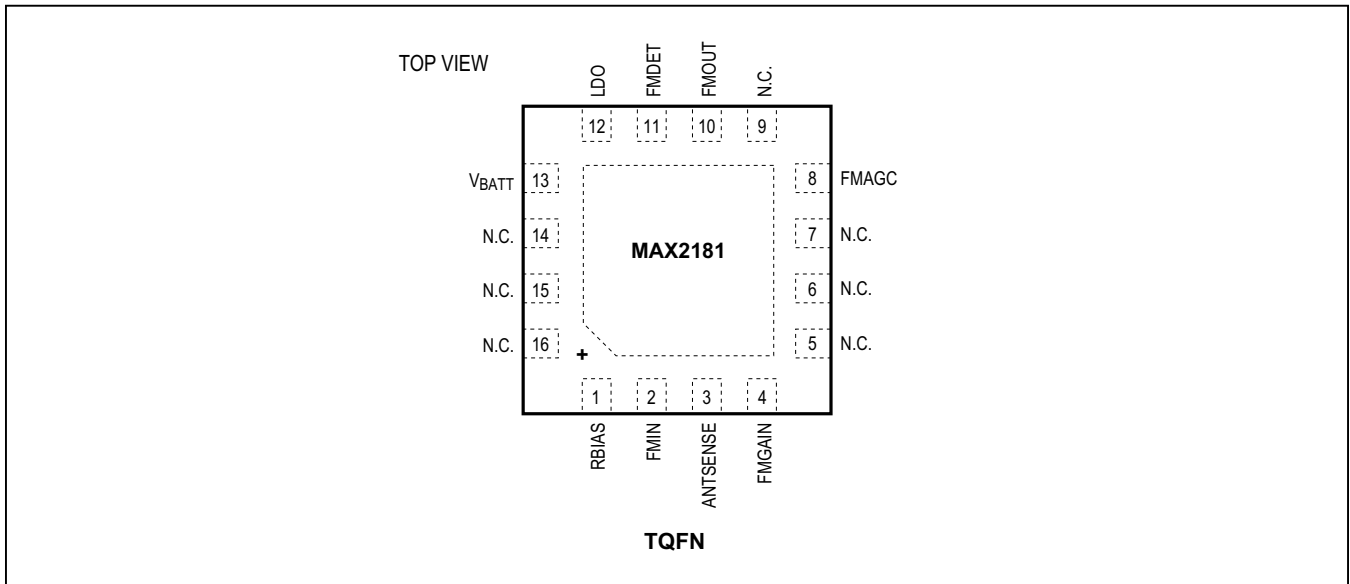

### Pin Description

PIN	NAME	FUNCTION
1	RBIAS	Connect a 1% tolerance 20kΩ resistor to ground.
2	FMIN	FM Input. AC couple to FM input bandpass filter.
3	ANTSENSE	Connect to antenna input connector center conductor through a 100kΩ resistor.
4	FMGAIN	FM Gain Trim. Connect to ground, leave open, or connect to V <sub>LDO</sub> for the desired FM gain.
5–7, 9, 14–16	N.C.	No Connection to Die. Suggested thermal path on Layer 1 of PCB for packages exposed pad to thermal sink.
8	FMAGC	FM AGC Control Line. Connect a 1μF capacitor to ground.
10	FMOUT	FM VGA Output
11	FMDET	FM Attack Point Trim. Connect the desired resistor to ground.
12	LDO	DC Regulator Output. Connect a bypass capacitor to ground.
13	V <sub>BATT</sub>	Battery Supply Pin
—	EP	Exposed Pad. Ground.

## Detailed Description

### Setting Signal Path Gain and AGC Attack Point

The MAX2181 allows independent variation of the gain and AGC attack points on the FM signal path. Gain and attack point are adjusted by changing the conditions on the FMGAIN and FMDET pins.

#### FM Signal Path

Typical FM gain can be set using the FMGAIN pin as shown in Table 1. The output attack point of the FM signal path is adjusted by changing the resistor RFMDET, connected to the FMDET pin. Table 2 shows the attack point associated with several resistor values.

**Table 1. FM Signal Path Gain**

PIN FMGAIN	FM GAIN (dB, TYP)
Ground	6.0
Open	7.2
V <sub>LDO</sub>	8.3

**Table 2. FM Signal Path Attack Point**

RFMDET (kΩ)	FM OUTPUT ATTACK POINT (dBμV, TYP)
0	92
13	93.5
22	95
33	97
43	99
51	101.5
62	104
71	106

### Antenna Sensing

In some applications, a bias voltage might be present on the car antenna or the car antenna might be DC shorted to ground in normal operation. In these situations, the device can sense an antenna fault condition and report this by setting the V<sub>BATT</sub> current.

Connecting the ANTSENSE pin to the car antenna through a 100kΩ resistor enables this function. If a DC bias of 6V to 12V is present on the antenna, the device operates normally. If the antenna is DC shorted to ground, the device also operates normally. However, if the antenna is a DC open circuit, the device V<sub>BATT</sub> current drops to a value between 15mA to 25mA. This provides a method for the car audio system to detect an antenna fault. If this function is not required, the ANTSENSE pin should be connected to ground.

### Layout Recommendations

For best performance, the device must be mounted on a PCB that is designed for a low thermal resistance. A thermal ground must be placed near the device. This can consist of a mounting screw to a large thermal mass, ideally placed no more than 5mm from the package. The backside ground of the MAX2181 must be connected to a thermal ground plane on the PCB using at least nine plated through holes. Finally, a wide trace on the PCB top metal from the paddle area, connecting pins 5-7 and 14-16, and proceeding to the mounting hole further improves thermal performance.

The MAX2181 is equipped with thermal-protection circuitry that maintains junction temperature at safe levels when the device is operated outside its specified operating range. For ambient temperatures up to +85°C and V<sub>BATT</sub> up to +15V, the thermal protection does not engage.

Refer to [www.maximintegrated.com](http://www.maximintegrated.com) for the MAX2181 Evaluation Kit schematic, Gerber data, PADS layout file, and BOM information.

Typical Application Circuit

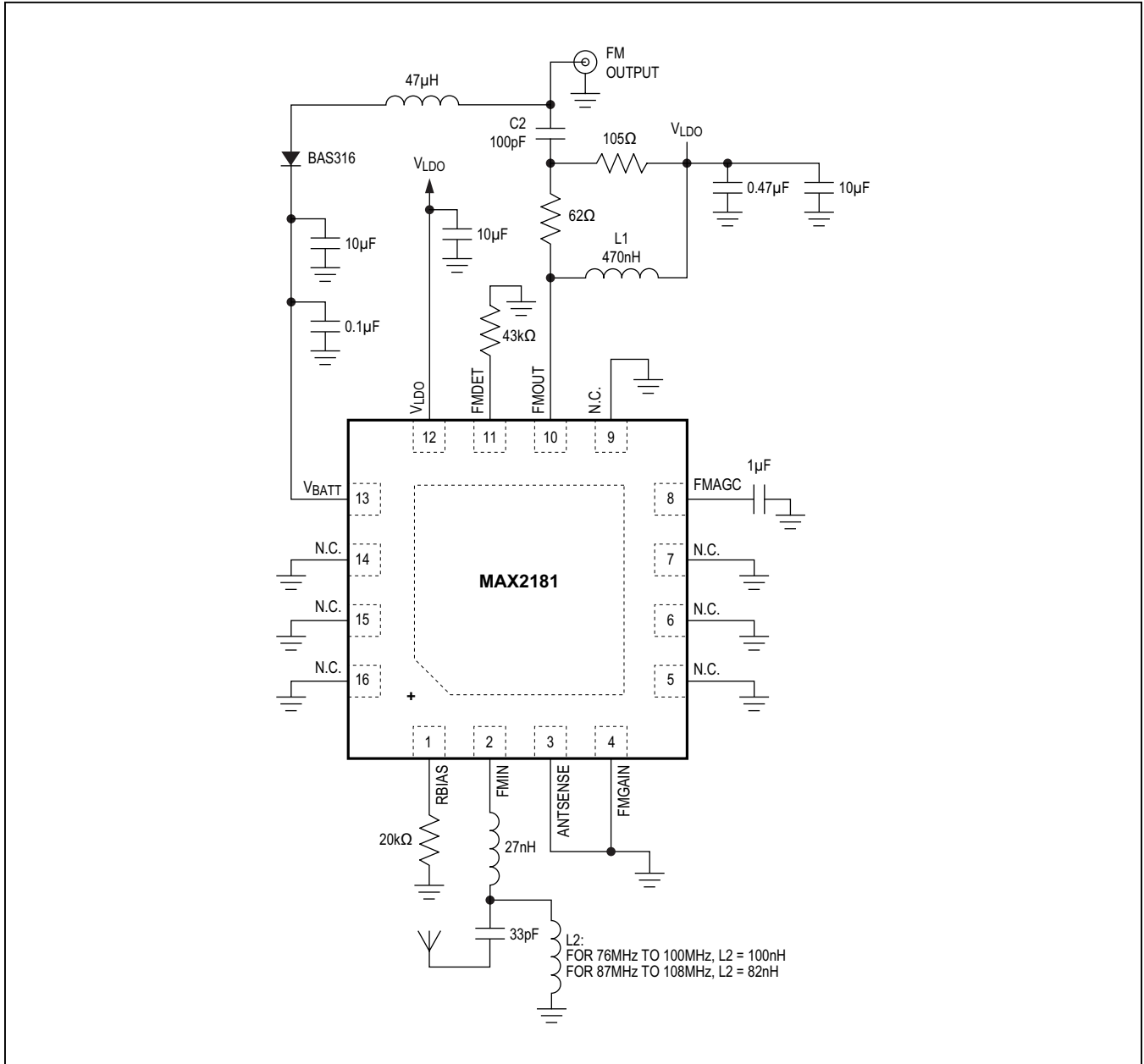

## Ordering Information

PART	TEMP RANGE	PIN-PACKAGE
MAX2181ETE+	-40°C to +85°C	16 TQFN-EP*
MAX2181ETE/V+	-40°C to +85°C	16 TQFN-EP*

+Denotes a lead(Pb)-free/RoHS-compliant package.

\*EP = Exposed pad.

/V denotes an automotive qualified part.

## Package Information

For the latest package outline information and land patterns (footprints), go to [www.maximintegrated.com/packages](http://www.maximintegrated.com/packages). Note that a "+", "#", or "-" in the package code indicates RoHS status only. Package drawings may show a different suffix character, but the drawing pertains to the package regardless of RoHS status.

PACKAGE TYPE	PACKAGE CODE	OUTLINE NO.	LAND PATTERN NO.
16 TQFN	T1633+2	<a href="#">21-0136</a>	<a href="#">90-0030</a>



## Revision History

REVISION NUMBER	REVISION DATE	DESCRIPTION	PAGES CHANGED
0	12/12	Initial release	—

For pricing, delivery, and ordering information, please contact Maxim Direct at 1-888-629-4642, or visit Maxim Integrated's website at [www.maximintegrated.com](http://www.maximintegrated.com).

*Maxim Integrated cannot assume responsibility for use of any circuitry other than circuitry entirely embodied in a Maxim Integrated product. No circuit patent licenses are implied. Maxim Integrated reserves the right to change the circuitry and specifications without notice at any time. The parametric values (min and max limits) shown in the Electrical Characteristics table are guaranteed. Other parametric values quoted in this data sheet are provided for guidance.*

# Mouser Electronics

Authorized Distributor

Click to View Pricing, Inventory, Delivery & Lifecycle Information:

[Analog Devices Inc.:](#)

[MAX2181ETE/V+](#) [MAX2181EVKIT#](#)

Other:

[MAX2181ETE/V+T](#)