

## 200mA, 70V SMD Switching Diode

### FEATURES

- Fast switching speed
- Ideal for automated placement
- Moisture sensitivity level: level 1, per J-STD-020
- RoHS Compliant
- Halogen-free according to IEC 61249-2-21

### APPLICATIONS

- Switching mode power supply (SMPS)

### MECHANICAL DATA

- Case: SOT-23
- Molding compound meets UL 94 V-0 flammability rating
- Terminal: Matte tin plated leads, solderable per J-STD-002
- Meet JESD 201 class 1A whisker test
- Weight:  $8 \pm 0.5$  mg (approximately)

KEY PARAMETERS		
PARAMETER	VALUE	UNIT
$I_F$	200	mA
$V_{RRM}$	70	V
$I_{FSM}$	2	A
$V_F$ at $I_F=150mA$	1.25	V
$T_{J\ MAX}$	150	°C
Package	SOT-23	



ABSOLUTE MAXIMUM RATINGS ( $T_A = 25^\circ\text{C}$ unless otherwise noted)					
PARAMETER	SYMBOL	BAW56	BAV70	BAV99	UNIT
Marking code on the device		A1	A4	A7	
Power dissipation	$P_D$	225			mW
Repetitive peak reverse voltage	$V_{RRM}$	70			V
Repetitive peak forward current	$I_{FRM}$	450			mA
Forward current	$I_F$	200			mA
Non-Repetitive peak forward surge current	@ $t = 1s$	0.5			A
	@ $t = 1\mu s$	2			
Junction temperature range	$T_J$	-55 to +150			°C
Storage temperature range	$T_{STG}$	-55 to +150			°C

<b>THERMAL PERFORMANCE</b>			
<b>PARAMETER</b>	<b>SYMBOL</b>	<b>TYP</b>	<b>UNIT</b>
Junction-to-ambient thermal resistance	$R_{\theta JA}$	556	$^{\circ}C/W$

<b>ELECTRICAL SPECIFICATIONS</b> ( $T_A = 25^{\circ}C$ unless otherwise noted)						
<b>PARAMETER</b>	<b>CONDITIONS</b>	<b>SYMBOL</b>	<b>MIN</b>	<b>MAX</b>	<b>UNIT</b>	
Forward voltage per diode <sup>(1)</sup>	$I_F = 50mA, T_J = 25^{\circ}C$	$V_F$	-	1.00	V	
	$I_F = 150mA, T_J = 25^{\circ}C$			1.25		
Reverse voltage	$I_R = 100 \mu A, T_J = 25^{\circ}C$	$V_R$	70	-	V	
Reverse current @ rated $V_R$ per diode <sup>(2)</sup>	$V_R = 70 V, T_J = 25^{\circ}C$	$I_R$	-	2.5	$\mu A$	
Junction capacitance	BAW56, BAV70	$f=1 MHz, V_R=1V$	$C_J$	-	2	pF
	BAV99			-	1.5	
Reverse recovery time	$I_F=I_R= 10mA, R_L= 100\Omega, I_{RR}= 1mA$	$t_{rr}$	-	6	ns	

**Notes:**

1. Pulse test with PW=0.3 ms
2. Pulse test with PW=30 ms

<b>ORDERING INFORMATION</b>		
<b>ORDERING CODE</b>	<b>PACKAGE</b>	<b>PACKING</b>
BAxxx RF	SOT-23	3K / 7" Reel
BAxxx RFG	SOT-23	3K / 7" Reel
BAxxx-B0 RF	SOT-23	3K / 7" Reel
BAxxx-B0 RFG	SOT-23	3K / 7" Reel
BAxxx-D0 RF	SOT-23	3K / 7" Reel
BAxxx-D0 RFG	SOT-23	3K / 7" Reel

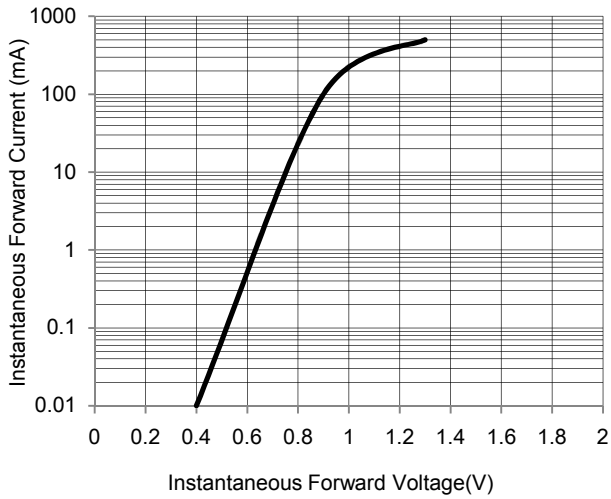
**Notes:**

1. "xx" is device code from "W56" to "V99"
2. "G" means green compound (halogen free)

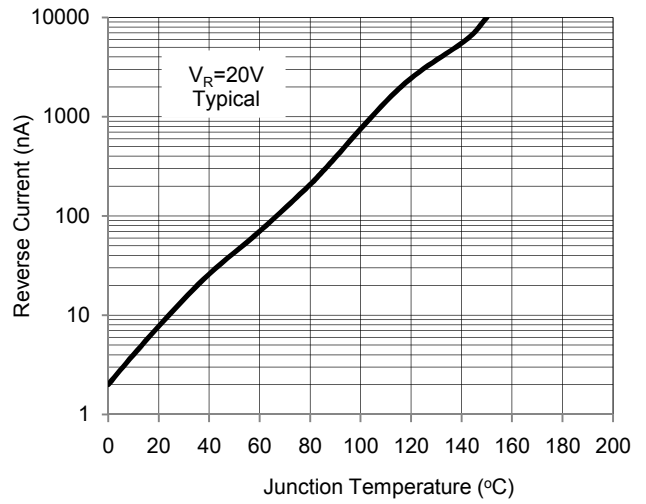
**CHARACTERISTICS CURVES**

( $T_A = 25^\circ\text{C}$  unless otherwise noted)

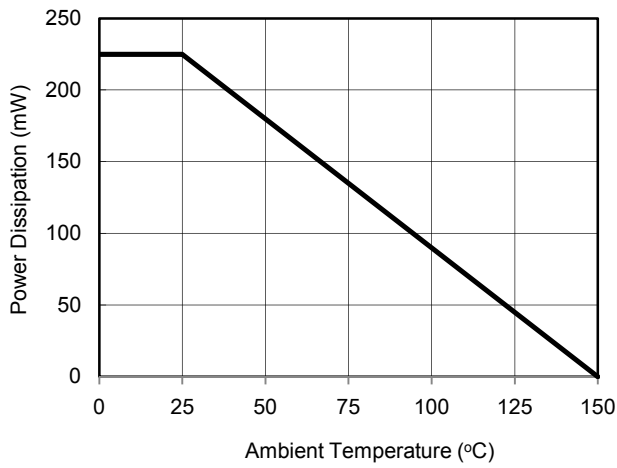
**Fig.1 Typical Forward Characteristics**



**Fig. 2 Reverse Current VS. Junction Temperature**

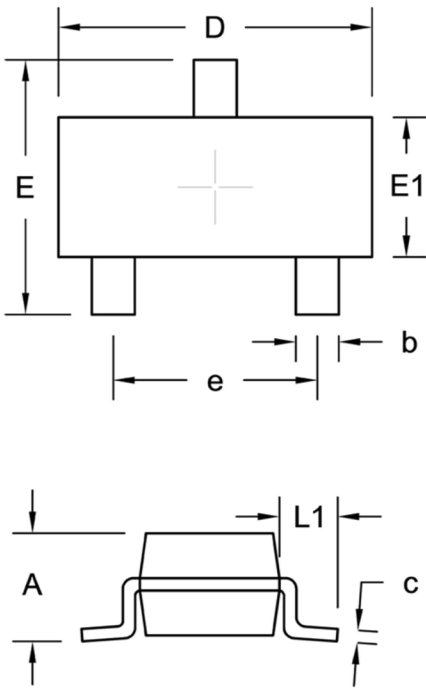


**Fig.3 Admissible Power Dissipation Curve**



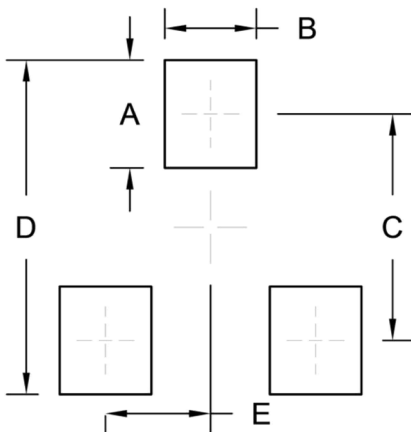
**PACKAGE OUTLINE DIMENSION**

SOT-23



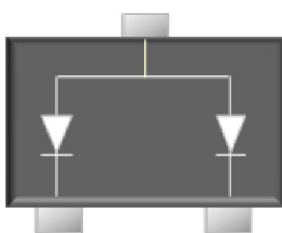
DIM.	Unit (mm)		Unit (inch)	
	Min.	Max.	Min.	Max.
A	0.89	1.12	0.035	0.044
b	0.30	0.50	0.012	0.020
c	0.08	0.20	0.003	0.008
D	2.80	3.04	0.110	0.120
E	2.10	2.64	0.083	0.104
E1	1.20	1.40	0.047	0.055
e	1.90 BSC		0.075 BSC	
L1	0.54 REF.		0.021 REF.	

**SUGGESTED PAD LAYOUT**

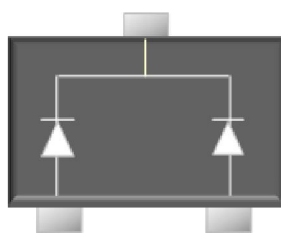


Symbol	Unit (mm)	Unit (inch)
A	1.00	0.039
B	0.85	0.033
C	2.10	0.083
D	3.10	0.122
E	0.98	0.039

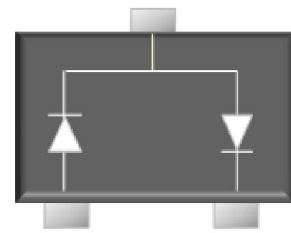
**PIN CONFIGURATION**



**BAW56**



**BAV70**



**BAV99**

## Notice

Specifications of the products displayed herein are subject to change without notice. TSC or anyone on its behalf, assumes no responsibility or liability for any errors or inaccuracies.

Purchasers are solely responsible for the choice, selection, and use of TSC products and TSC assumes no liability for application assistance or the design of Purchasers' products.

Information contained herein is intended to provide a product description only. No license, express or implied, to any intellectual property rights is granted by this document. Except as provided in TSC's terms and conditions of sale for such products, TSC assumes no liability whatsoever, and disclaims any express or implied warranty, relating to sale and/or use of TSC products including liability or warranties relating to fitness for a particular purpose, merchantability, or infringement of any patent, copyright, or other intellectual property right.

The products shown herein are not designed for use in medical, life-saving, or life-sustaining applications. Customers using or selling these products for use in such applications do so at their own risk and agree to fully indemnify TSC for any damages resulting from such improper use or sale.

# Mouser Electronics

Authorized Distributor

Click to View Pricing, Inventory, Delivery & Lifecycle Information:

[Taiwan Semiconductor:](#)

[BAV99S](#) [BAV99S RFG](#)