



CM 06 EA 14S-6 S

Circular connector CM-series:Cable socket

Product description

Description	Straight cable socket, strain relief by means of a clamp
Type	CM 06 EA 14S-6 S
Order No.	932 458-100
Number of contacts	6
Cable gland	PG 11
Cable diameter	8 mm to 10 mm
Conductor size	max. 1 mm ²
Standard	MIL-C 5015 bzw. VG 95 342
Housing Color	black

Drawing

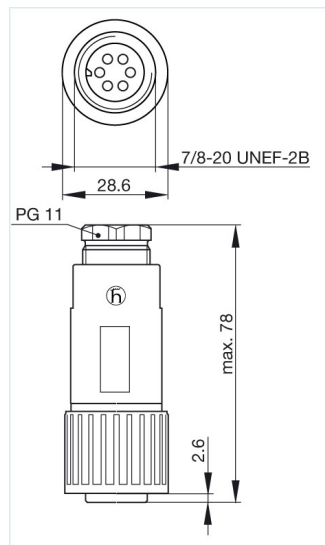

Technical data

Pin dimensions	1.6 mm
Rated voltage	50 V AC/DC
Rated current	10 A
Contact resistance	≤ 5 mOhm
Type of termination	solder
Shell size	14S

Material

Contact surface material	Ag
Contact bearer material	PA 66-GF 25
Housing material	PA 66-GF 25
O-Ring	NBR

Environmental conditions

Protection class (IEC 60529)	IP 67
Pollution severity	3
Temperature range	-40 °C to +90 °C
Inflammability class	
Flammability, UL standard	94 V-1
Packaging unit	
Packaging unit	100 pieces
Scope of delivery and accessories	
Scope of delivery	1 cable socket, not assembled, assembly instructions
Accessories to order separately	can be plugged into CM 02 E 14S-6 P; cap CM 06 SD 14S, order no. 831 621-100