

## Your configured drive

Part number\*: B7744E741F97 Revision 1

**maxon motor**

**driven by precision**

Motor - DC-max22S GB SL 24V  
Planetary gearhead - GPX22 C 243:1

maxon motor worldwide  
[http://www.maxonmotor.com/maxon/view/content/contact\\_page](http://www.maxonmotor.com/maxon/view/content/contact_page)

E-Mail: [e-shop@maxonmotor.com](mailto:e-shop@maxonmotor.com)  
Internet: [www.maxonmotor.com](http://www.maxonmotor.com)

After an order is placed at the e-shop, the product is manufactured in Switzerland and delivered after 11 working days.  
General Terms and Conditions: [http://www.maxonmotor.com/maxon/view/content/terms\\_and\\_conditions\\_page](http://www.maxonmotor.com/maxon/view/content/terms_and_conditions_page)

### Interactive 3D model

Click on the icon to activate your 3D model

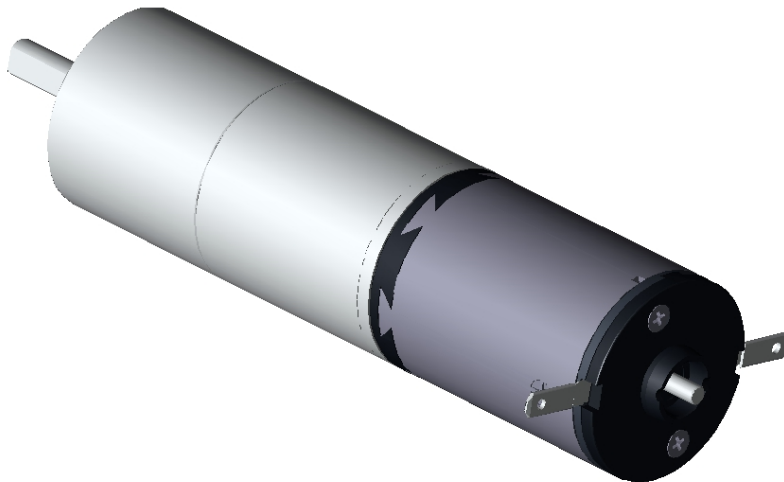

Your configuration can be viewed here:

<http://www.maxonmotor.co.uk/maxon/view/configurator/?ConfigID=B7744E741F97>

\*If the link doesn't work, you can open your configuration with the part number from the catalog.

### Attachments / CAD files

Please double click with left mouse button on a pushpin symbol to open a file. You could also save a file when you click the symbol with the right mouse button.

B7744E741F97.stp (STP AP 214)

**Motor - DC-max22S GB SL 24V  
Planetary gearhead - GPX22 C 243:1**

Drawings are not to scale!

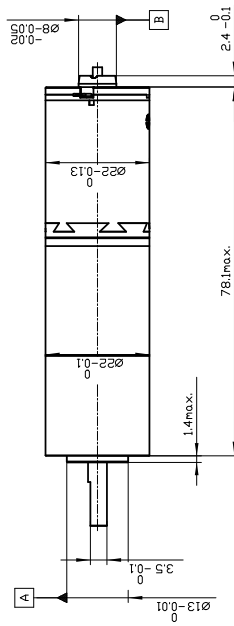
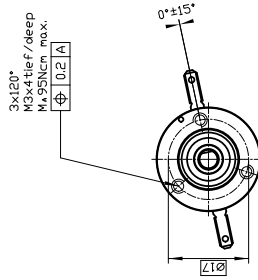
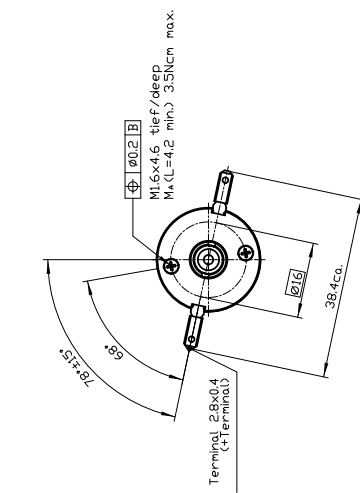

Durchmesser über Schweisstellen 22.2 max.  
Diameter at welds 22.2 max.

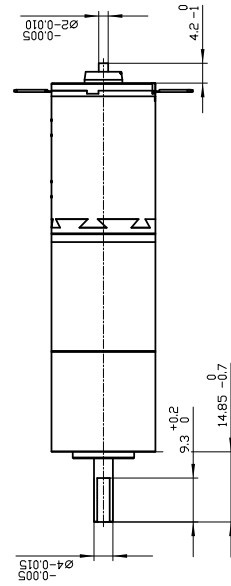

## Summary of your selected configuration

**Motor - DC-max22S GB SL 24V**  
**Planetary gearhead - GPX22 C 243:1**

Total weight of the drive: 142 g

### Motor: DC-max22S GB SL 24V

Commutation	Graphite brushes
Nominal voltage	24 V
Motor bearings	Sintered sleeve bearings

### Gearhead GPX22 C 243:1

Gearhead type	Ceramic version
Reduction	243:1
Number of stages	4

## Operating range

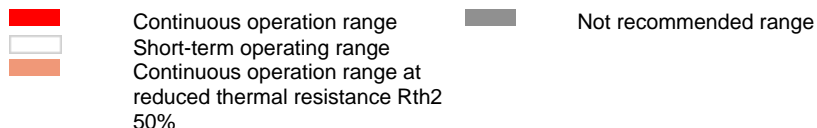
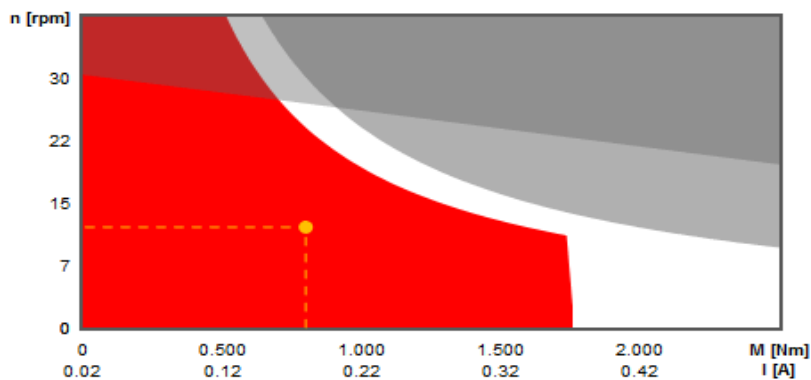

## Motor - DC-max22S GB SL 24V



### Values at nominal voltage

Nominal voltage	24 V
No load speed	7330 rpm
No load current	15.1 mA
Nominal speed	5350 rpm
Nominal torque (max. continuous torque)	11.8 mNm
Nominal current (max. continuous current)	0.397 A
Stall torque	44.6 mNm
Stall current	1.45 A
Max. efficiency	80.2 %

### Characteristics

Max. output power	9.81 W
Terminal resistance	16.6 Ohm
Terminal inductance	1.05 mH
Torque constant	30.8 mNm/A
Speed constant	310 rpm/V
Speed/torque gradient	167 rpm/mNm
Mechanical time constant	8.2 ms
Rotor inertia	4.69 gcm <sup>2</sup>

### Thermal data

Thermal resistance housing-ambient	20 K/W
Thermal resistance winding-housing	6 K/W
Thermal time constant of the winding	14.3 s
Thermal time constant of the motor	538 s
Ambient temperature	-30..85 °C
Max. winding temperature	125 °C

**Mechanical data**

Max. permissible speed	9000 rpm
Min. axial play	0.05 mm
Max. axial play	0.15 mm
Radial backlash	0.012
Max. axial load (dynamic)	1 N
Max. force for press fits (static)	80 N
Max. radial load 5 mm from flange	2.8 N

**Further specifications**

Number of pole pairs	1
Number of commutator segments	9
Weight	47 g
Number of autoclave cycles	0
Typical noise level	55 dBA

Information about motor data: [http://www.maxonmotor.com/medias/CMS\\_Downloads/DIVERSES/12\\_137\\_EN.pdf](http://www.maxonmotor.com/medias/CMS_Downloads/DIVERSES/12_137_EN.pdf)

## Planetary gearhead - GPX22 C 243:1



### Gearhead data

Reduction	243:1
Absolute reduction	31640625/130321
Max. transmittable power (continuous)	2 W
Max. transmittable power (intermittent)	2.5 W
Number of stages	4
Max. continuous torque	2 Nm
Max. intermittent torque	2.5 Nm
Direction of rotation, drive to output	=
Max. efficiency	66 %
Weight	95 g
Average backlash no-load	1.4 degree
Mass inertia	0.56 gcm <sup>2</sup>
Gearhead length	42.9 mm

### Technical data

Output shaft bearing	Ball bearings
Gearhead type	GPX
Max. radial play	0.2 mm
mm from flange	10 mm
Min. axial play	0 mm
Max. axial play	0.2 mm
Max. permissible radial load	120 N
mm from flange	10 mm
Max. axial load (dynamic)	40 N
Max. force for press fits	100 N
Max. continuous input speed	12000 rpm
Max. intermittent input speed	15000 rpm
Min. recommended temperature range	-40..100 °C
Number of autoclave cycles	0

Information about gearhead data: [http://www.maxonmotor.com/medias/CMS\\_Downloads/DIVERSES/12\\_203\\_EN.pdf](http://www.maxonmotor.com/medias/CMS_Downloads/DIVERSES/12_203_EN.pdf)