

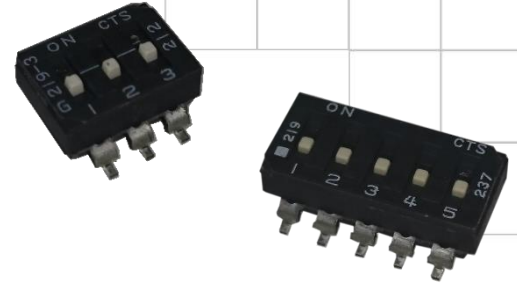

Series 219

SMD DIP Switch

- Removable tape seal to withstand IR vapor phase or wave soldering temperatures, and board washing
- Gull-wing and “J” bend terminal configurations
- Available low profile, medium, and extended height actuators
- SPST configuration available
- 0.6mm/.024” actuator travel
- Optional top tape seal for board spray washing



Description

Positive detent separated from contactor causes contactor does not deflect during actuation. Unique compact type design allows to be used at small size application. Optional top tape sealed structure is optimized for board washing during soldering process. It makes it the ideal choice for any server, security and HVAC systems.

Ordering Information

Series	Number of Switch Positions	Actuator Height	Bottom Seal	Top Tape Seal	Terminal Type	Packaging Type	Actuation Preset
219-	12	LP	S	T	J	R	F

Code	No. of switch positions
2	2 positions
3	3 positions
4	4 positions
5	5 positions
6	6 positions
7	7 positions
8	8 positions
9	9 positions
10	10 positions
12	12 positions

Code	Top tape seal
Blank	No top tape seal
T	Top tape seal (Not available on extended actuator)

Code	Spec.
Blank	Anti-static tube packaging
R	Tape & reel packaging

Code	Spec.
Blank	Gull wing terminal
J	J bend terminal

Code	Spec.
Blank	Ship at ON position
F	Ship at OFF position

Code	Spec.
E	Extended height actuator (0.6mm/.024")
M	Medium actuator (0.25mm/.010")
LP	Low profile (Flush)

Notes: Contact CTS for other common features not listed.

Electrical Specifications

Parameter	Conditions & Remarks	Min	Max	Unit
Circuit	SPST	2	12	position
Contact Resistance	Initial		25	milliohms
	At end of life		50	
Insulation Resistance	Between insulated terminals	1000		megohms
Dielectric Strength	500 VAC between adjacent switches		1	minute
Actuation Life	100mA @ 20 VDC		2,000	cycles
	0.1mA @ 5 VDC (dry circuit)			
Switch Capacitance	Between adjacent closed switches		5	pF
Nonswitching Rating			100	mA
			or	or
			50	VDC

Mechanical and Environmental

Soldering	Maximum reflow temperature, 250°C for 30 seconds
MSL	Level 1
RoHS	Lead-Free. Fully compliant to RoHS Directive 2011/65/EU
Shock	Per MIL-STD-202F, method 213B, condition A(50G's) with no contact inconsistencies greater than 1 microsecond
Vibration	Per MIL-STD-202F, method 204D, condition B (.06" or 15G's between 10 HZ to 2K HZ) with no contact inconsistencies greater than 1 microsecond
Coplanarity	0.1mm/.004" maximum
Seal	Bottom epoxy seal standard Top tape seal optional
Marking	Special marking available-consult CTS
Packaging:	Standard anti-static tube packaging Optional tape and reel packaging
Operating Temperature Range	-55°C to +85°C
Storage Temperature Range	-55°C to +85°C

Soldering Profile

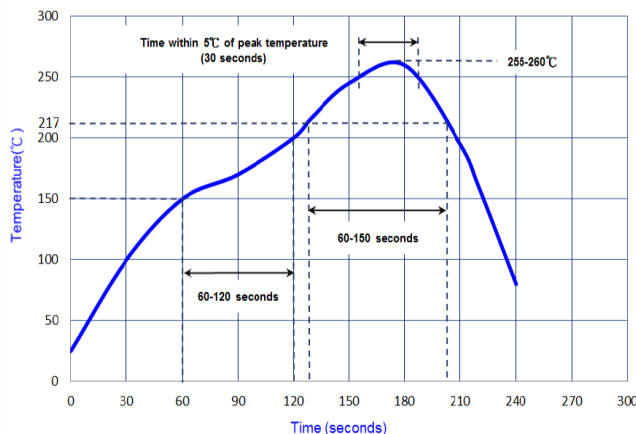

Mechanical Specifications

CTS SERIES 219 SMT CONTACT FEATURES

1. Value of Redundant (Bifurcated) Gold Plated Contacts: Redundancy dramatically reduces the probability of contact failure while gold contact material provides the highest environmental protection, IMPROVING RELIABILITY.
2. Value of Wiping Contact Action: Clean contact area, IMPROVING RELIABILITY.
3. Value of Contactor Not Deflecting During Actuation: Constant contact pressure eliminates overstressing contacts, IMPROVING RELIABILITY.
4. Value of Detent Separate from Contactor: Separate detent allows optimization of nondeflecting contactor and detent designs, IMPROVING RELIABILITY.

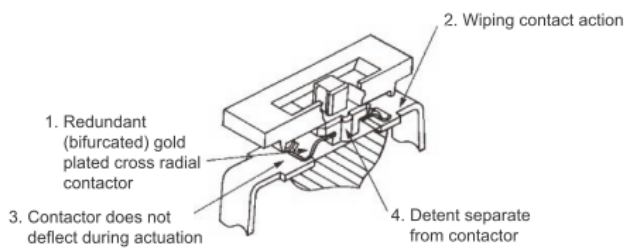

"A" Overall Dimension	No. of Switch positions
6.55/.258	2
9.09/.358	3
11.63/.458	4
14.17/.558	5
16.71/.658	6
19.25/.758	7
21.79/.858	8
24.33/.958	9
26.87/1.058	10
31.95/1.258	12

Figure 1 – Surface Mount J Bend Terminal

"J" Bend Terminals Low Profile Actuator

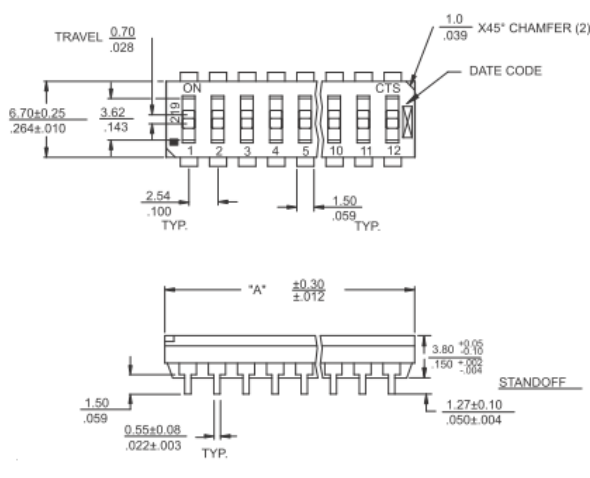

"J" Bend Surface Mount Pad Layouts

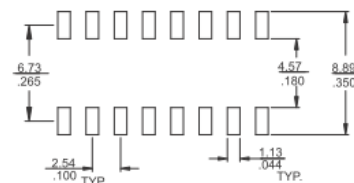

DIMENSION: $\frac{\text{mm}}{\text{inch}}$
 STANDARD TOLERANCE:
 X (1 PLACE): ± 0.3 , XX (2 PLACE): ± 0.13
 ± 0.012 , ± 0.005

Figure 2 – Surface Mount Gull Wing Terminal

Gull Wing Surface Mount Pad Layouts

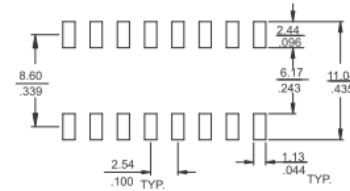

**Gull Wing Terminals
Medium Height Actuator**

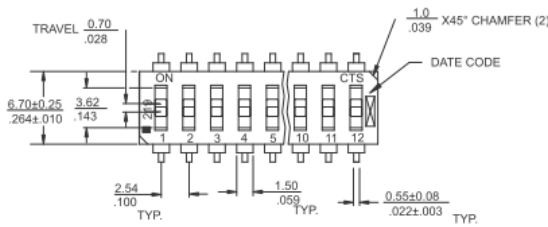

DIMENSION: $\frac{\text{mm}}{\text{inch}}$
 STANDARD TOLERANCE :
 .X (1 PLACE) : ± 0.3 .XX(2 PLACE) : ± 0.13
 ± 0.012 ± 0.005

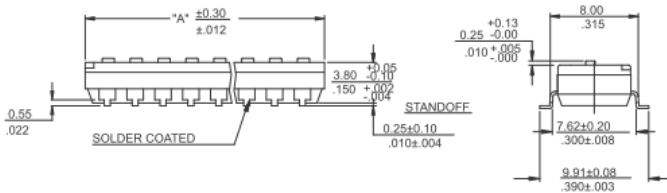

Packing: Tape and Reel

Unit: mm

SW Section	Fig	Bo	W	F	SO
2	I	7.50	16.0	7.5	-
3	I	10.00	16.0	7.5	-
4	I	12.50	24.0	11.5	-
5	I	15.10	24.0	11.5	-
6	I	17.60	24.0	11.5	-
7	II	20.20	32.0	14.2	28.4
8	II	22.70	44.0	20.2	40.4
9	II	25.22	44.0	20.2	40.4
10	II	27.80	44.0	20.2	40.4
12	II	32.90	44.0	20.2	40.4

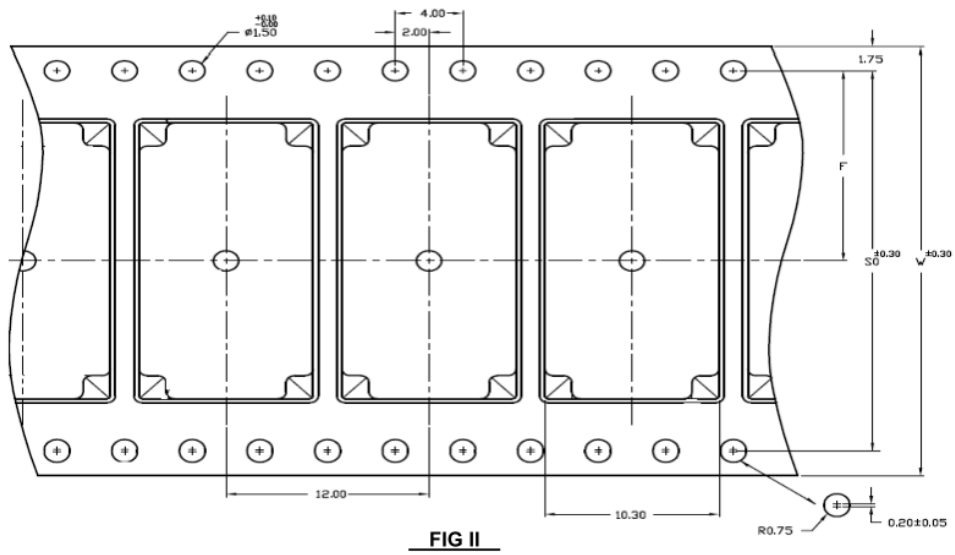
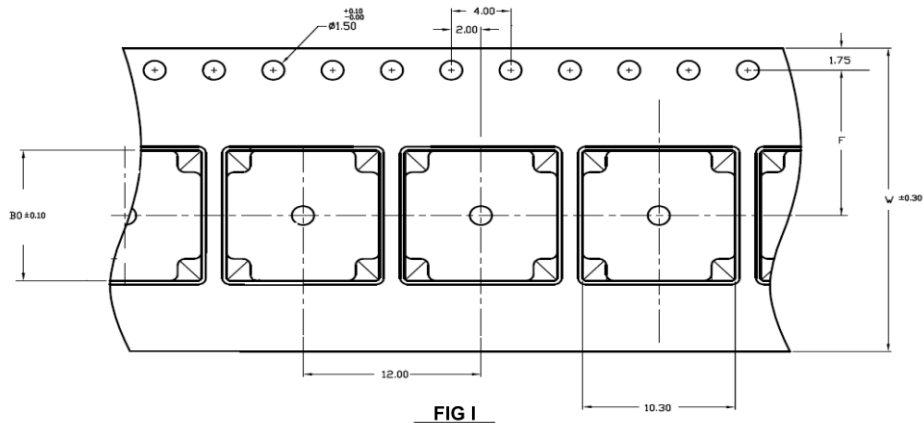

SPECIFIED REEL PARTS DIMENSIONS:

Unit: mm

SW Section	W1	W2	W3
2~3	16.4	22.4 MAX.	15.9 MIN./19.5 MAX.
4~6	24.4	30.4 MAX.	23.9 MIN./27.4 MAX.
7	32.4	38.4 MAX.	31.9 MIN./35.4 MAX.
8~12	44.4	50.4 MAX.	43.9 MIN./47.4 MAX.

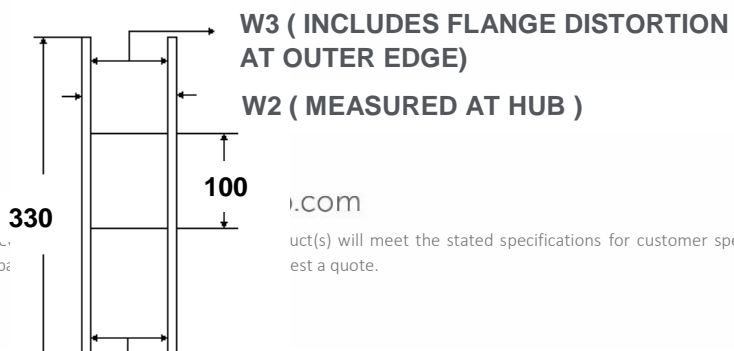

1. TAPE SPROCKET HOLE PITCH : $4.0 \pm 0.1\text{MM}$
2. ALL SMT ASSEMBLING MACHINES WILL PICK-UP THE COMPONENT FROM THE POINT, WHICH
3. IS LOCATED IN THE CENTRE OF TWO ADJACENT SPROCKET HOLES IN FEEDING DIRECTION. THIS MUST BE TAKEK INTO ACCOUNT WHEN DESIGNING THE LOCATION OF THE COMPONENT IN T&R POCKET.
4. RECOMMENDED PART ORIENTATION IN TAPE & REEL POCKET. ORIENT SWITCH TERMINAL #1 TO THE SIDE OF ROUND SPROCKET HOLES, SEE PICTURE BELOW.



LENGTH OF TAPE

5. THERE SHALL BE A LEADER OF 390mm MINIMUM WHICH IS SEALED ONTO EMPTY CARRIER TAPE, SEE PICTURE BELOW.

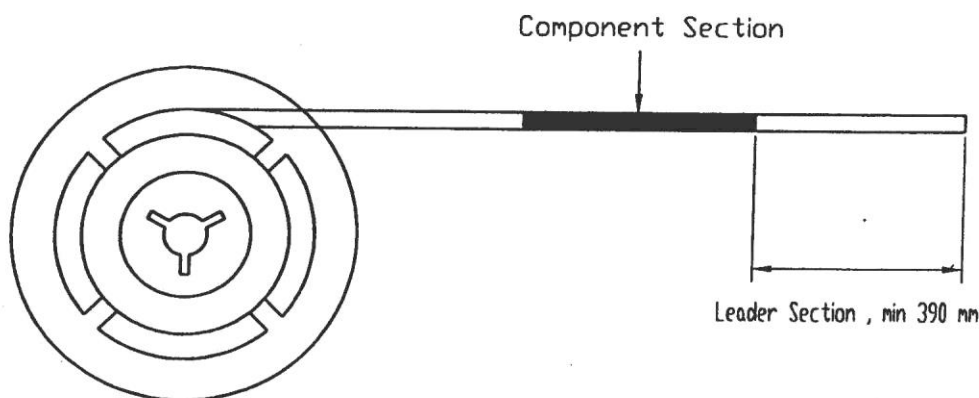

(see enlargement underneath)

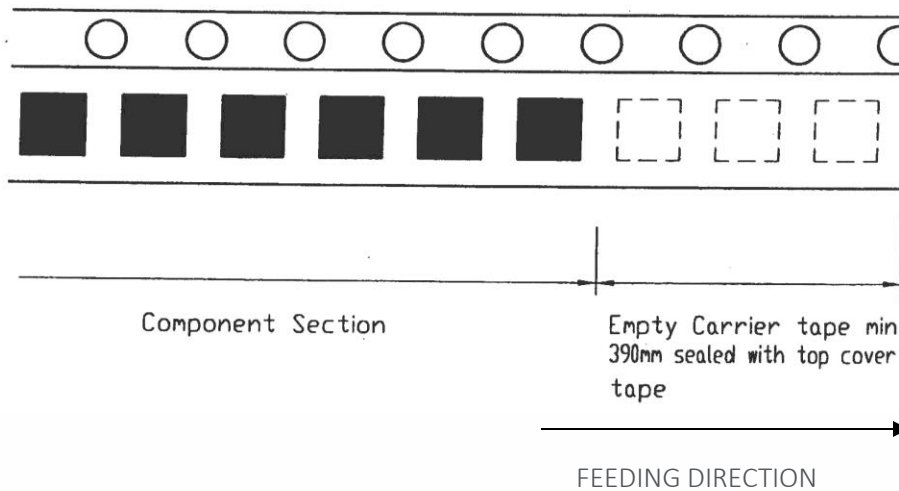

- 6 TAPE BREAK FORCE, PEEL STRENGTH AND ANGLE.
REQUIRED SETTINGS :
- TOP COVER TAPE PEEL FORCE : 10 ~ 130 gm
 - ANGLE BETWEEN THE TOP COVER TAPE AND THE DIRECTION OF FEED DURING PEEL OFF : 165° ~ 180°

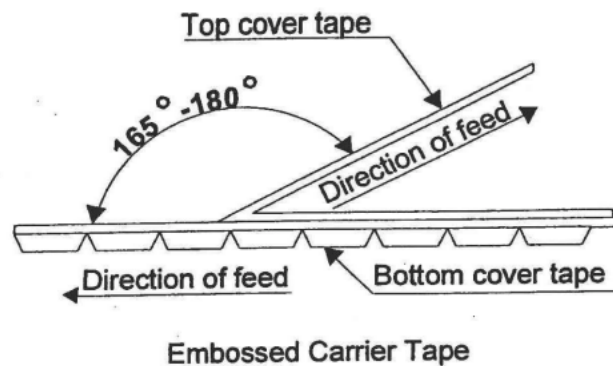

Mouser Electronics

Authorized Distributor

Click to View Pricing, Inventory, Delivery & Lifecycle Information:

CTS:

[219-2MSTR](#) [219-3LPSTR](#) [219-3MSTR](#) [219-5LPSTR](#) [219-5MSTR](#) [219-6LPSTR](#) [219-6MSTR](#) [219-7LPSTR](#) [219-7MSTR](#) [219-8LPSTR](#) [219-8MSTR](#) [219-9LPSTR](#) [219-9MSTR](#) [219-10LPSTR](#) [219-10MSTR](#) [219-12LPSTR](#) [219-12MSTR](#) [219-10LPST](#) [219-10MST](#) [219-12LPST](#) [219-12MST](#) [219-2LPST](#) [219-2LPSTR](#) [219-2MST](#) [219-3LPST](#) [219-3MST](#) [219-4LPST](#) [219-4MST](#) [219-5LPST](#) [219-5MST](#) [219-6LPST](#) [219-6MST](#) [219-7LPST](#) [219-8LPST](#) [219-8MST](#) [219-9LPST](#) [219-4LPSTR](#) [219-4LPSTRF](#) [219-7MST](#) [219-4MSTR](#) [219-9MST](#) [219-6LPSTJ](#) [219-5LPSTJ](#) [219-6MSTJ](#) [219-8LPSTJ](#) [219-8LPS](#) [219-6MSTRF](#) [219-4ES](#) [219-3MSTJ](#) [219-2LPSTRF](#) [219-4LPSTJRF](#) [219-4MSTJR](#) [219-6LPS](#) [219-9LPS](#) [219-12ESF](#) [219-9MSTJR](#) [219-2MS](#) [219-2LPSTF](#) [219-8LPSTF](#) [219-2MSTRF](#) [219-4MSTF](#) [219-3LPSTJ](#) [219-8MSTJ](#) [219-4LPSTJR](#) [219-4MS](#) [219-8MS](#) [219-3LPS](#) [219-4MSTRF](#) [219-4LPS](#) [219-4MSTJRF](#) [219-4LPSTP](#) [219-8LPSTRF](#) [219-5LPSTRF](#) [219-6LPSR](#) [219-6LPSTJF](#) [219-3MSTF](#) [219-10LPSTF](#) [219-12LPSJR](#) [219-6LPSJ](#) [219-10MSTJRF](#) [219-5MSTF](#) [219-8MSTF](#) [219-3LPSTRF](#) [219-2ESRF](#) [219-8LPSTJR](#) [219-9LPSTRF](#) [219-2MSTJRF](#) [219-5LPSTJRF](#) [219-8LPSTJRF](#) [219-5MSTJRF](#) [219-5MSTRF](#) [219-6MSJRF](#) [219-7LPSJ](#) [219-7MSR](#) [219-7MSTRF](#) [219-8ESRF](#) [219-8LPSF](#) [219-9ESJRF](#) [219-9ESR](#) [219-9LPSJRF](#)