

THB AC and Pulse Metallized Polypropylene Film Capacitors High Temperature AEC-Q200 Qualified

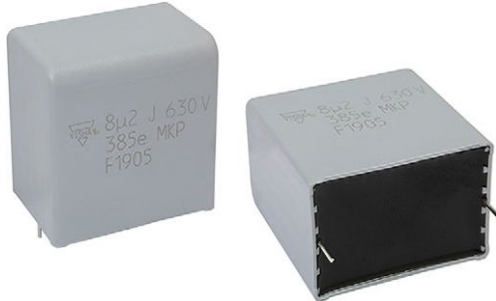

FEATURES



- AEC-Q200 qualified (rev. D)
- THB 60 °C 93 % RH for 56 days at rated voltage
- High temperature capabilities, up to 125 °C
- Customization on request
- Material categorization:
for definitions of compliance please see
www.vishay.com/doc?99912

 AUTOMOTIVE
GRADE

RoHS
COMPLIANT

APPLICATIONS

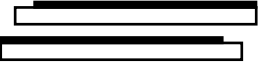
- Hybrid and electrical vehicles applications
- On-board and inductive charging systems
 - BMS (battery management)
 - High pulse and high frequency currents
 - Snubbing
 - Resonant converters

| QUICK REFERENCE DATA | |
|--|--|
| Rated capacitance range (E12 series) | 0.001 μ F to 15 μ F |
| Capacitance tolerance | $\pm 5\%$ / $\pm 10\%$ |
| Rated voltage range, U_{RDC} | 400 V_{DC} , 630 V_{DC} , 850 V_{DC} , 1000 V_{DC} , 1250 V_{DC} , 1600 V_{DC} , 2000 V_{DC} , 2500 V_{DC} |
| Permissible AC voltage | 200 V_{AC} , 220 V_{AC} , 300 V_{AC} , 350 V_{AC} , 450 V_{AC} , 550 V_{AC} , 700 V_{AC} , 900 V_{AC} |
| Climatic testing class | 40 / 105 / 56 |
| Rated temperature | 85 °C |
| Max. operation temperature | 105 °C up to 125 °C observing voltage derating |
| Reference standards | IEC 60384-17, AEC-Q200 qualified (rev. D) up to 105 °C |
| Dielectric | Polypropylene film |
| Electrodes | Metallized |
| Construction | Mono construction (for $\leq 630 V_{DC}$)  Series construction (for $> 630 V_{DC}$)  |
| Encapsulation | Plastic case, epoxy resin sealed, flame retardant UL-class 94 V-0 |
| Leads | Tinned wire |
| Withstanding DC voltage between terminals ⁽¹⁾ | 1.6 U_{RDC} for 60 s (maximum rise time 1000 V/s; cut off current 10 mA) |
| Test voltage between terminals and case | 1.4 U_{RAC} + 2000 V_{DC} for 60 s |
| Insulation resistance | RC between leads, after 1 min: for $U_{RDC} < 500 V$ measuring voltage 100 V for $U_{RDC} \geq 500 V$ measuring voltage 500 V > 100 G Ω for $C \leq 0.33 \mu$ F > 30 000 s for $C > 0.33 \mu$ F |
| Marking | C-value, tolerance, rated voltage, code for dielectric material, manufacturer location, manufacturer's type, manufacturer's logo, year and week |

Notes

- For more detailed data and test requirements, contact dc-film@vishay.com
- ⁽¹⁾ See document "Voltage Proof Test for Metallized Capacitors" www.vishay.com/doc?28169



| VOLTAGE RATINGS AND TEMPERATURE | | | | | | | | |
|---|-----|------|------|------|------|------|---------------------|------|
| VOLTAGE RATINGS $T_{amb} = 85\text{ }^{\circ}\text{C}$ | | | | | | | | |
| Rated DC voltage U_{RDC} | 400 | 630 | 850 | 1000 | 1250 | 1600 | 2000 | 2500 |
| Rated AC voltage U_{RAC} | 200 | 220 | 300 | 350 | 450 | 550 | 700 ⁽¹⁾ | 800 |
| Rated peak to peak voltage V_{p-p} ($2 \times U_{RAC} \times \sqrt{2}$) | 560 | 620 | 850 | 1000 | 1250 | 1600 | 2000 ⁽¹⁾ | 2250 |
| Peak voltage V_{o-p} ($U_{RDC} \times 1.6$) | 640 | 1008 | 1360 | 1600 | 2000 | 2560 | 3200 | 4000 |
| Maximum temporary RMS over voltage (< 24 h) ($1.25 \times U_{RAC}$) | 250 | 275 | 375 | 438 | 563 | 688 | 875 | 1000 |
| VOLTAGE RATINGS $85\text{ }^{\circ}\text{C} < T_{amb} \leq 105\text{ }^{\circ}\text{C}$ | | | | | | | | |
| U_{OPDC} ($U_{RDC} \times 0.7$) | 280 | 441 | 595 | 700 | 875 | 1120 | 1400 | 1750 |
| U_{OPAC} ($U_{RAC} \times 0.7$) | 140 | 154 | 210 | 245 | 315 | 385 | 490 ⁽²⁾ | 560 |
| Rated peak to peak voltage V_{p-p} ($2 \times U_{OPAC} \times \sqrt{2}$) | 396 | 436 | 594 | 693 | 891 | 1089 | 1386 ⁽²⁾ | 1584 |
| Peak voltage V_{o-p} ($U_{RDC} \times 1.1$) | 440 | 693 | 935 | 1100 | 1375 | 1760 | 2200 | 2750 |
| Maximum temporary RMS over voltage (< 24 h) ($0.875 \times U_{RAC}$) | 175 | 193 | 263 | 306 | 394 | 481 | 613 ⁽²⁾ | 700 |
| VOLTAGE RATINGS $105\text{ }^{\circ}\text{C} < T_{amb} \leq 125\text{ }^{\circ}\text{C}$ (for limited time < 500 h) | | | | | | | | |
| U_{OPDC} ($U_{RDC} \times 0.5$) | 200 | 315 | 425 | 500 | 625 | 800 | 1000 | 1250 |
| U_{OPAC} ($U_{RAC} \times 0.5$) | 100 | 110 | 150 | 175 | 225 | 275 | 350 ⁽³⁾ | 400 |
| Rated peak to peak voltage V_{p-p} ($2 \times U_{OPAC} \times \sqrt{2}$) | 283 | 311 | 424 | 495 | 636 | 778 | 990 ⁽³⁾ | 1131 |
| Peak voltage V_{o-p} ($U_{RDC} \times 0.8$) | 320 | 504 | 680 | 800 | 1000 | 1280 | 1600 | 2000 |
| Maximum temporary RMS over voltage (< 24 h) ($0.625 \times U_{RAC}$) | 125 | 138 | 188 | 219 | 281 | 344 | 438 ⁽³⁾ | 500 |

Notes

- (1) Rated AC voltage is 600 V_{AC} and rated peak to peak voltage is 1700 V_{AC} for pitch 37.5 mm
- (2) U_{OPAC} ($U_{RAC} \times 0.7$) = 420 V_{AC} ; peak to peak voltage V_{p-p} ($2 \times U_{OPAC} \times \sqrt{2}$) = 1188 V; maximum temporary RMS over voltage (< 24 h) ($0.875 \times U_{RAC}$) = 525 V_{AC}
- (3) (U_{OPAC} ($U_{RAC} \times 0.5$) = 300 V_{AC} ; Peak to peak voltage V_{p-p} ($2 \times U_{OPAC} \times \sqrt{2}$) = 849 V; maximum temporary RMS over voltage (< 24 h) ($0.625 \times U_{RAC}$) = 375 V_{AC}

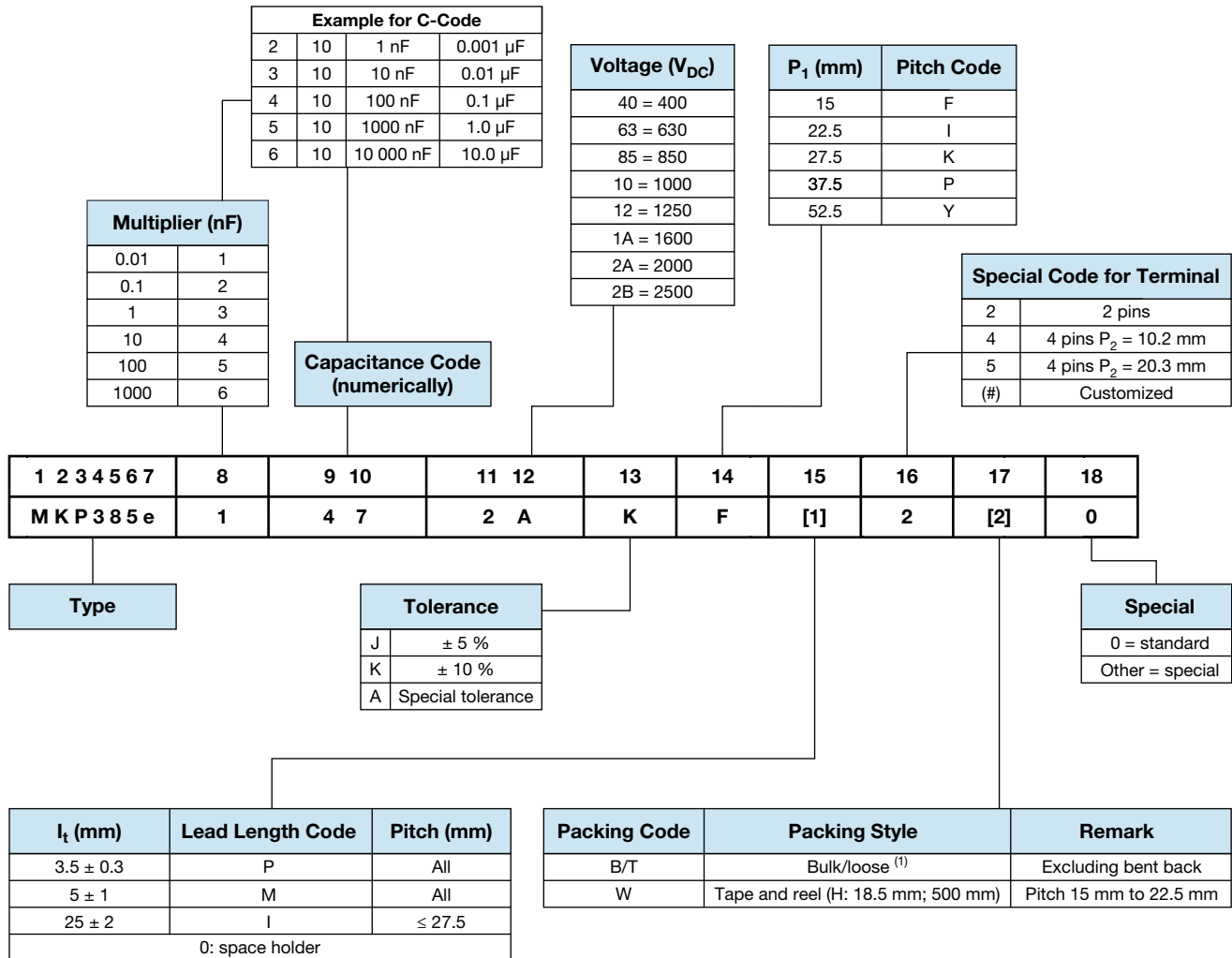
COMPOSITION OF CATALOG NUMBER

Notes

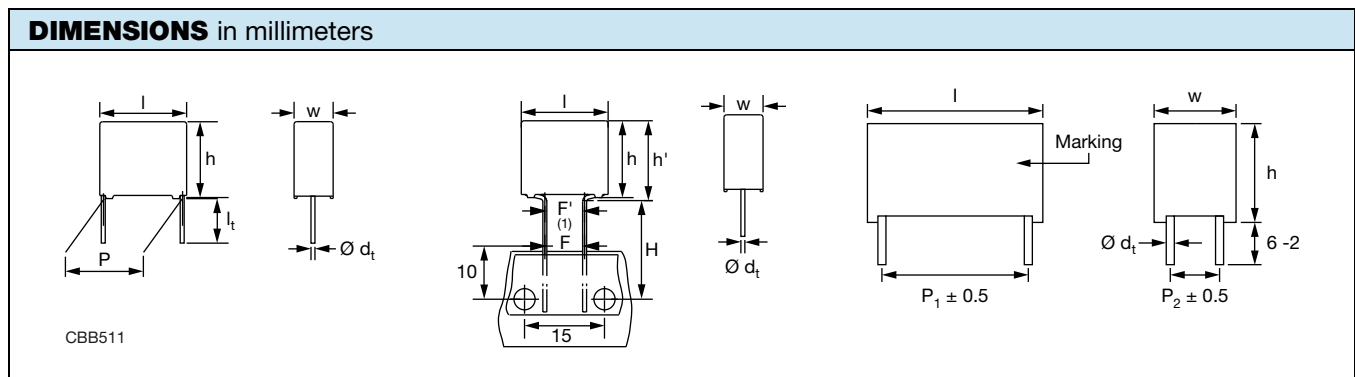
- For detailed tape specifications refer to packaging information www.vishay.com/doc?28139
- ⁽¹⁾ Capacitors with short leads up to 5 mm and pitch > 15 mm will be in tray and asking code will be "T"

Note

- ⁽¹⁾ $|F - F'| < 0.3$ mm
 $F = 7.5$ mm + 0.6 mm / - 0.1 mm
 $\phi d_t = 0.80$ mm $\pm 10\%$ for $P < 37.5$ mm and $\phi d_t = 0.95$ mm $\pm 10\%$ for $P \geq 37.5$ mm



| ELECTRICAL DATA AND ORDERING CODE | | | | | | | | | | | | | | | | |
|--|--------------------|--------------------------|---------|---------|---------------------------|-----------------------|-------------------------------------|--------|-------------------------|--------|--|-----------------|--|-----|-----------------|-----------------|
| U _{RDC} (V) | CAP. (µF) | DIMENSION w x h x l (mm) | P1 (mm) | P2 (mm) | du/dt (V/µs) _R | I _{PEAK} (A) | I _{RMS} ⁽¹⁾ (A) | | ESR ⁽²⁾ (mΩ) | | tan δ ⁽³⁾ (10 ⁻⁴) | | ORDERING CODE ⁽⁴⁾ MKP385e.... | | | |
| | | | | | | | 2 PINS | 4 PINS | 2 PINS | 4 PINS | 2 PINS | 4 PINS | | | | |
| U_{RAC} = 200 V, U_{p-p} = 560 V, C-TOL. = ± 10 % | | | | | | | | | | | | | | | | |
| 400 | 0.047 | 7.0 x 13.5 x 17.5 | 15 | - | 115 | 5.4 | 1.6 | - | 78 | - | 35 | - | 34740KF[1]2[2]0 | | | |
| | 0.056 | | | | | 6.4 | 1.8 | - | 66 | - | 35 | - | 35640KF[1]2[2]0 | | | |
| | 0.068 | | | | | 7.8 | 1.9 | - | 54 | - | 35 | - | 36840KF[1]2[2]0 | | | |
| | 0.082 | | | | | 9.4 | 1.9 | - | 58 | - | 45 | - | 38240KF[1]2[2]0 | | | |
| | 0.10 | | | | | 11.5 | 2.1 | - | 47 | - | 45 | - | 41040KF[1]2[2]0 | | | |
| | 0.12 | | | | | 13.8 | 2.3 | - | 39 | - | 45 | - | 41240KF[1]2[2]0 | | | |
| | 0.15 | | | | | 17.3 | 2.8 | - | 32 | - | 45 | - | 41540KF[1]2[2]0 | | | |
| | 0.18 | 8.5 x 15.0 x 17.5 | | | | 20.7 | 3.0 | - | 26 | - | 45 | - | 41840KF[1]2[2]0 | | | |
| | 0.22 | | | | | 25.3 | 2.6 | - | 36 | - | 75 | - | 42240KF[1]2[2]0 | | | |
| | 0.27 | | | | | 31.1 | 3.1 | - | 29 | - | 75 | - | 42740KF[1]2[2]0 | | | |
| | 0.33 | 10.0 x 16.5 x 17.5 | | | | 38.0 | 3.4 | - | 24 | - | 75 | - | 43340KF[1]2[2]0 | | | |
| | 0.39 | | | | | 44.9 | 3.9 | - | 20 | - | 75 | - | 43940KF[1]2[2]0 | | | |
| | 0.47 | 11.0 x 18.5 x 18.0 | | | | 54.1 | 4.4 | - | 17 | - | 75 | - | 44740KF[1]2[2]0 | | | |
| | 0.22 | 7.0 x 16.5 x 26.0 | | | | 22.5 | - | 130 | 28.6 | 2.7 | - | 36 | - | 75 | - | 42240KI[1]2[2]0 |
| | 0.27 | | 35.1 | 3.0 | - | | | | 29 | - | 75 | - | 42740KI[1]2[2]0 | | | |
| | 0.33 | 42.9 | 3.6 | - | 24 | | | | - | 75 | - | 43340KI[1]2[2]0 | | | | |
| | 0.39 | 50.7 | 3.9 | - | 20 | | | | - | 75 | - | 43940KI[1]2[2]0 | | | | |
| | 0.47 | 10.0 x 19.5 x 26.0 | 61.1 | 4.5 | - | | | | 17 | - | 75 | - | 44740KI[1]2[2]0 | | | |
| | 0.56 | | 72.8 | 4.3 | - | | | | 19 | - | 100 | - | 45640KI[1]2[2]0 | | | |
| | 0.68 | 12.0 x 22.0 x 26.0 | 88.4 | 5.2 | - | | | | 15 | - | 100 | - | 46840KI[1]2[2]0 | | | |
| | 0.82 | | 106.6 | 5.4 | - | | | | 14 | - | 110 | - | 48240KI[1]2[2]0 | | | |
| | 1.00 | | 130.0 | 6.0 | - | | | | 12 | - | 110 | - | 51040KI[1]2[2]0 | | | |
| | 1.20 | 12.5 x 22.5 x 26.5 | 156.0 | 6.7 | - | | | | 10 | - | 110 | - | 51240KI[1]2[2]0 | | | |
| | 0.47 | 9.0 x 19.0 x 31.0 | 27.5 | - | 80 | | | | 37.6 | 3.7 | - | 22 | - | 100 | - | 44740KK[1]2[2]0 |
| | 0.56 | | | | | | | | 44.8 | 4.1 | - | 19 | - | 100 | - | 45640KK[1]2[2]0 |
| | 0.68 | 54.4 | | | | | | | 4.9 | - | 15 | - | 100 | - | 46840KK[1]2[2]0 | |
| | 0.82 | 11.0 x 21.0 x 31.0 | | | | | | | 65.6 | 5.1 | - | 14 | - | 110 | - | 48240KK[1]2[2]0 |
| | 1.0 | | | | | 80.0 | 6.2 | - | 9 | - | 110 | - | 51040KK[1]2[2]0 | | | |
| | 1.2 | 13.0 x 23.0 x 31.0 | | | | 96.0 | 6.6 | - | 10 | - | 110 | - | 51240KK[1]2[2]0 | | | |
| | 1.5 | | | | | 120.0 | 7.4 | - | 8 | - | 110 | - | 51540KK[1]2[2]0 | | | |
| | 1.8 | 15.0 x 25.0 x 31.0 | | | | 144.0 | 8.1 | - | 7 | - | 125 | - | 51840KK[1]2[2]0 | | | |
| | 2.2 | 18.0 x 28.0 x 31.0 | | | | 176.0 | 9.8 | - | 6 | - | 125 | - | 52240KK[1]2[2]0 | | | |
| | 2.7 | | | | | 216.0 | 10.3 | - | 5 | - | 140 | - | 52740KK[1]2[2]0 | | | |
| | 3.3 | 21.0 x 31.0 x 31.0 | | | | 264.0 | 11.5 | - | 5 | - | 160 | - | 53340KK[1]2[2]0 | | | |
| | 3.9 | | | | | 312.0 | 12.6 | - | 4 | - | 160 | - | 53940KK[1]2[2]0 | | | |
| | 3.3 | 15.7 x 28.5 x 41.5 | | | | 37.5 | - | 45 | 148.5 | 9.8 | - | 7 | - | 190 | - | 53340KP[1]2T0 |
| | 3.9 | | | | | | | | 175.5 | 10.2 | - | 7 | - | 200 | - | 53940KP[1]2T0 |
| | 4.7 | 18.0 x 32.5 x 41.5 | 211.5 | 11.6 | - | | | | 6 | - | 225 | - | 54740KP[1]2T0 | | | |
| | 5.6 | | 252.0 | 12.0 | - | | | | 6 | - | 245 | - | 55640KP[1]2T0 | | | |
| | 6.8 | 21.5 x 38.5 x 43.0 | 306.0 | 14.0 | 14.7 | | | | 5 | 5 | 285 | 260 | 56840KP[1]4T0 | | | |
| 8.2 | 369.0 | | 14.2 | 15.0 | 5 | | | | 5 | 325 | 295 | 58240KP[1]4T0 | | | | |
| 10 | 24.0 x 44.0 x 42.0 | 450.0 | 15.4 | 16.2 | 5 | | | | 5 | 390 | 355 | 61040KP[1]4T0 | | | | |
| 12 | 30.0 x 45.0 x 42.0 | 540.0 | 16.6 | 17.4 | 5 | | | | 5 | 465 | 420 | 61240KP[1]5T0 | | | | |
| 15 | | 675.0 | 16.4 | 17.2 | 5 | | | | 5 | 595 | 540 | 61540KP[1]5T0 | | | | |

Notes

- (1) I_{RMS} at 85 °C ambient temperature and 100 kHz
- (2) ESR at 85 °C and 100 kHz
- (3) Maximum tan δ value at 100 kHz
- (4) Please replace "[1]" by the lead length code and the "[2]" by the packaging type in accordance with section "Composition of Catalog Number"



ELECTRICAL DATA AND ORDERING CODE

| U _{RDC} (V) | CAP. (μF) | DIMENSION w x h x l (mm) | P1 (mm) | P2 (mm) | du/dt (V/μs) _R | I _{PEAK} (A) | I _{RMS} ⁽¹⁾ (A) | | ESR ⁽²⁾ (mΩ) | | tan δ ⁽³⁾ (10 ⁻⁴) | | ORDERING CODE ⁽⁴⁾ MKP385e.... | | | |
|--|--------------|--------------------------------|------------|------------|------------------------------|--------------------------|--|-----------|----------------------------|-----------|---|-----------|---|---------------|---------------|-----------------|
| | | | | | | | 2 PINS | 4 PINS | 2 PINS | 4 PINS | 2 PINS | 4 PINS | | | | |
| U_{RAC} = 220 V, U_{p-p} = 620 V, C-TOL. = ± 10 % | | | | | | | | | | | | | | | | |
| 630 | 0.027 | 7.0 x 13.5 x 17.5 | 15 | - | 130 | 3.5 | 1.3 | - | 117 | - | 30 | - | 32763KF[1]2[2]0 | | | |
| | 0.033 | | | | | 4.3 | 1.5 | - | 95 | - | 30 | - | 33363KF[1]2[2]0 | | | |
| | 0.039 | | | | | 5.1 | 1.6 | - | 81 | - | 30 | - | 33963KF[1]2[2]0 | | | |
| | 0.047 | | | | | 6.1 | 1.7 | - | 67 | - | 30 | - | 34763KF[1]2[2]0 | | | |
| | 0.056 | | | | | 7.3 | 1.8 | - | 66 | - | 35 | - | 35663KF[1]2[2]0 | | | |
| | 0.068 | | | | | 8.8 | 1.9 | - | 54 | - | 35 | - | 36863KF[1]2[2]0 | | | |
| | 0.082 | 8.5 x 15.0 x 17.5 | | | | 22.5 | - | 150 | 10.7 | 2.1 | - | 58 | - | 45 | - | 38263KF[1]2[2]0 |
| | 0.10 | | | | | | | | 13.0 | 2.3 | - | 47 | - | 45 | - | 41063KF[1]2[2]0 |
| | 0.12 | | | | | | | | 15.6 | 2.5 | - | 39 | - | 45 | - | 41263KF[1]2[2]0 |
| | 0.15 | | | | | | | | 19.5 | 3.0 | - | 32 | - | 45 | - | 41563KF[1]2[2]0 |
| | 0.18 | | | | | | | | 23.4 | 3.3 | - | 26 | - | 45 | - | 41863KF[1]2[2]0 |
| | 0.22 | | | | | | | | 28.6 | 2.9 | - | 36 | - | 75 | - | 42263KF[1]2[2]0 |
| | 0.27 | 11.0 x 18.5 x 18.0 | 27.5 | - | 90 | | | | 35.1 | 3.4 | - | 29 | - | 75 | - | 42763KF[1]2[2]0 |
| | 0.12 | 7.0 x 16.5 x 26.0 | | | | | | | 18.0 | 2.6 | - | 39 | - | 45 | - | 41263KI[1]2[2]0 |
| | 0.15 | | | | | | | | 22.5 | 2.9 | - | 32 | - | 45 | - | 41563KI[1]2[2]0 |
| | 0.18 | | | | | | | | 27.0 | 3.4 | - | 26 | - | 45 | - | 41863KI[1]2[2]0 |
| | 0.22 | 8.5 x 18.0 x 26.0 | | | | | | | 33.0 | 2.9 | - | 36 | - | 75 | - | 42263KI[1]2[2]0 |
| | 0.27 | | | | | | | | 40.5 | 3.4 | - | 29 | - | 75 | - | 42763KI[1]2[2]0 |
| | 0.33 | | | | | 49.5 | 3.8 | - | 24 | - | 75 | - | 43363KI[1]2[2]0 | | | |
| | 0.39 | 10.0 x 19.5 x 26.0 | | | | 58.5 | 4.5 | - | 20 | - | 75 | - | 43963KI[1]2[2]0 | | | |
| | 0.47 | | | | | 70.5 | 5.0 | - | 17 | - | 75 | - | 44763KI[1]2[2]0 | | | |
| | 0.56 | | | | | 84.0 | 4.7 | - | 19 | - | 100 | - | 45663KI[1]2[2]0 | | | |
| | 0.27 | 9.0 x 19.0 x 31.0 | | | | 25 | - | 50 | 24.3 | 3.3 | - | 29 | - | 75 | - | 42763KK[1]2[2]0 |
| | 0.33 | | | | | | | | 29.7 | 3.6 | - | 24 | - | 75 | - | 43363KK[1]2[2]0 |
| | 0.39 | | 35.1 | 4.3 | - | | | | 20 | - | 75 | - | 43963KK[1]2[2]0 | | | |
| | 0.47 | 11.0 x 21.0 x 31.0 | 42.3 | 4.7 | - | | | | 17 | - | 75 | - | 44763KK[1]2[2]0 | | | |
| | 0.56 | | 50.4 | 4.4 | - | | | | 19 | - | 100 | - | 45663KK[1]2[2]0 | | | |
| | 0.68 | | 61.2 | 5.2 | - | | | | 15 | - | 100 | - | 46863KK[1]2[2]0 | | | |
| | 0.82 | 13.0 x 23.0 x 31.0 | 73.8 | 5.5 | - | | | | 14 | - | 110 | - | 48263KK[1]2[2]0 | | | |
| | 1.0 | | 90.0 | 6.5 | - | | | | 12 | - | 110 | - | 51063KK[1]2[2]0 | | | |
| | 1.2 | | 108.0 | 7.8 | - | | | | 10 | - | 110 | - | 51263KK[1]2[2]0 | | | |
| | 1.5 | 18.0 x 28.0 x 31.0 | 135.0 | 8.7 | - | | | | 8 | - | 110 | - | 51563KK[1]2[2]0 | | | |
| | 1.8 | | 162.0 | 9.6 | - | | | | 7 | - | 125 | - | 51863KK[1]2[2]0 | | | |
| | 2.2 | | 198.0 | 10.7 | - | | | | 6 | - | 125 | - | 52263KK[1]2[2]0 | | | |
| | 2.7 | 18 x 32.5 x 41.5 | 37.5 | - | 25 | 135.0 | 10.7 | - | 7 | - | 150 | - | 52763KP[1]2T0 | | | |
| | 3.3 | 18.5 x 35.5 x 43 | | | | 10.2 | 165.0 | 11.1 | 11.7 | 7 | 7 | 190 | 175 | 53363KP[1]4T0 | | |
| | 3.9 | | | | | | 195.0 | 11.8 | 12.4 | 7 | 7 | 225 | 205 | 53963KP[1]4T0 | | |
| | 4.7 | | | | | | 235.0 | 11.9 | 12.5 | 7 | 7 | 270 | 245 | 54763KP[1]4T0 | | |
| | 5.6 | 24 x 44 x 42 | | | | | 20.3 | 280.0 | 13.0 | 13.7 | 7 | 7 | 305 | 275 | 55663KP[1]4T0 | |
| | 6.8 | | | | | | | 340.0 | 14.6 | 15.3 | 6 | 6 | 340 | 310 | 56863KP[1]5T0 | |
| | 8.2 | | | | | | | 410.0 | 15.5 | 16.3 | 6 | 6 | 365 | 330 | 58263KP[1]5T0 | |
| | 15 | 35 x 50 x 57.5 | | | | 375.0 | | 16.8 | 17.6 | 7 | 7 | 840 | 760 | 61563KY[1]5T0 | | |

Notes

- (1) I_{RMS} at 85 °C ambient temperature and 100 kHz
- (2) ESR at 85 °C and 100 kHz
- (3) Maximum tan δ value at 100 kHz
- (4) Please replace "[1]" by the lead length code and the "[2]" by the packaging type in accordance with section "Composition of Catalog Number"



| ELECTRICAL DATA AND ORDERING CODE | | | | | | | | | | | | | |
|--|--------------|--------------------------------|------------|------------|------------------------------|--------------------------|--|-----------|----------------------------|-----------------|---|-----------|---|
| U _{RDC} (V) | CAP. (μF) | DIMENSION w x h x l (mm) | P1 (mm) | P2 (mm) | du/dt (V/μs) _R | I _{PEAK} (A) | I _{RMS} ⁽¹⁾ (A) | | ESR ⁽²⁾ (mΩ) | | tan δ ⁽³⁾ (10 ⁻⁴) | | ORDERING CODE ⁽⁴⁾ MKP385e.... |
| | | | | | | | 2 PINS | 4 PINS | 2 PINS | 4 PINS | 2 PINS | 4 PINS | |
| U_{RAC} = 300 V, U_{p-p} = 850 V, C-TOL. = ± 10 % | | | | | | | | | | | | | |
| 850 | 0.010 | 7.0 x 13.5 x 17.5 | 15 | - | 590 | 5.9 | 0.8 | - | 315 | - | 30 | - | 31085KF[1]2[2]0 |
| | 0.012 | | | | | 7.1 | 0.9 | - | 263 | - | 30 | - | 31285KF[1]2[2]0 |
| | 0.015 | | | | | 8.9 | 1.0 | - | 210 | - | 30 | - | 31585KF[1]2[2]0 |
| | 0.018 | | | | | 10.6 | 1.1 | - | 175 | - | 30 | - | 31885KF[1]2[2]0 |
| | 0.022 | | | | | 13.0 | 1.2 | - | 143 | - | 30 | - | 32285KF[1]2[2]0 |
| | 0.027 | | | | | 15.9 | 1.3 | - | 117 | - | 30 | - | 32785KF[1]2[2]0 |
| | 0.033 | | | | | 19.5 | 1.5 | - | 95 | - | 30 | - | 33385KF[1]2[2]0 |
| | 0.039 | | | | | 23.0 | 1.6 | - | 81 | - | 30 | - | 33985KF[1]2[2]0 |
| | 0.047 | | | | | 27.7 | 1.9 | - | 67 | - | 30 | - | 34785KF[1]2[2]0 |
| | 0.056 | | | | | 8.5 x 15.0 x 17.5 | 22.5 | - | 530 | 33.0 | 1.9 | - | 66 |
| | 0.068 | 40.1 | 2.1 | - | 54 | | | | | - | 35 | - | 36885KF[1]2[2]0 |
| | 0.082 | 10.0 x 16.5 x 17.5 | 27.5 | - | 330 | 48.4 | 2.2 | - | 58 | - | 45 | - | 38285KF[1]2[2]0 |
| | 0.10 | | | | | 59.0 | 2.4 | - | 47 | - | 45 | - | 41085KF[1]2[2]0 |
| | 0.12 | 10.5 x 17.5 x 18.0 | 37.5 | - | 150 | 70.8 | 2.8 | - | 39 | - | 45 | - | 41285KF[1]2[2]0 |
| | 0.033 | | | | | 17.5 | 1.7 | - | 95 | - | 30 | - | 33385KI[1]2[2]0 |
| | 0.039 | | | | | 20.7 | 1.8 | - | 81 | - | 30 | - | 33985KI[1]2[2]0 |
| | 0.047 | | | | | 24.9 | 2.0 | - | 67 | - | 30 | - | 34785KI[1]2[2]0 |
| | 0.056 | | | | | 29.7 | 2.1 | - | 66 | - | 35 | - | 35685KI[1]2[2]0 |
| | 0.068 | | | | | 36.0 | 2.4 | - | 54 | - | 35 | - | 36885KI[1]2[2]0 |
| | 0.082 | | | | | 43.5 | 2.3 | - | 58 | - | 45 | - | 38285KI[1]2[2]0 |
| | 0.10 | | | | | 53.0 | 2.5 | - | 47 | - | 45 | - | 41085KI[1]2[2]0 |
| | 0.12 | | | | | 63.6 | 2.8 | - | 39 | - | 45 | - | 41285KI[1]2[2]0 |
| | 0.15 | | | | | 79.5 | 3.3 | - | 32 | - | 45 | - | 41585KI[1]2[2]0 |
| | 0.18 | 95.4 | 3.6 | - | 26 | - | 45 | - | 41885KI[1]2[2]0 | | | | |
| | 0.22 | 116.6 | 3.4 | - | 36 | - | 75 | - | 42285KI[1]2[2]0 | | | | |
| | 0.27 | 143.1 | 3.8 | - | 29 | - | 75 | - | 42785KI[1]2[2]0 | | | | |
| | 0.33 | 174.9 | 4.2 | - | 24 | - | 75 | - | 43385KI[1]2[2]0 | | | | |
| | 0.10 | 9.0 x 19.0 x 31.0 | 27.5 | - | 330 | 33.0 | 2.6 | - | 47 | - | 45 | - | 41085KK[1]2[2]0 |
| | 0.12 | 11.0 x 21.0 x 31.0 | | | | 39.6 | 3.1 | - | 39 | - | 45 | - | 41285KK[1]2[2]0 |
| | 0.15 | | | | | 49.5 | 3.4 | - | 32 | - | 45 | - | 41585KK[1]2[2]0 |
| | 0.18 | | | | | 59.4 | 3.7 | - | 26 | - | 45 | - | 41885KK[1]2[2]0 |
| | 0.22 | | | | | 72.6 | 3.2 | - | 36 | - | 75 | - | 42285KK[1]2[2]0 |
| | 0.27 | | | | | 89.1 | 3.5 | - | 29 | - | 75 | - | 42785KK[1]2[2]0 |
| | 0.33 | | | | | 108.9 | 3.9 | - | 24 | - | 75 | - | 43385KK[1]2[2]0 |
| | 0.39 | | | | | 128.7 | 4.6 | - | 20 | - | 75 | - | 43985KK[1]2[2]0 |
| | 0.47 | | | | | 155.1 | 5.0 | - | 17 | - | 75 | - | 44785KK[1]2[2]0 |
| | 0.56 | | | | | 184.8 | 5.1 | - | 19 | - | 100 | - | 45685KK[1]2[2]0 |
| | 0.68 | | 224.4 | 5.6 | - | 15 | - | 100 | - | 46885KK[1]2[2]0 | | | |
| | 0.82 | 270.6 | 6.4 | - | 14 | - | 110 | - | 48285KK[1]2[2]0 | | | | |
| | 1.0 | 330.0 | 7.7 | - | 12 | - | 110 | - | 51085KK[1]2[2]0 | | | | |
| | 1.2 | 396.0 | 8.4 | - | 10 | - | 110 | - | 51285KK[1]2[2]0 | | | | |
| | 1.5 | 15.7 x 28.5 x 41.5 | 37.5 | - | 150 | 225.0 | 10.4 | - | 6 | - | 75 | - | 51585KP[1]2T0 |
| 1.7 | 255.0 | 11.5 | | | | - | 6 | - | 85 | - | 51785KP[1]2T0 | | |
| 1.8 | 270.0 | 11.5 | | | | - | 6 | - | 90 | - | 51885KP[1]2T0 | | |
| 2.2 | 330.0 | 12.4 | | | | 13.0 | 6 | 6 | 105 | 95 | 52285KP[1]4T0 | | |
| 2.7 | 405.0 | 13.5 | | | | 14.2 | 6 | 6 | 120 | 110 | 52785KP[1]4T0 | | |
| 3.3 | 495.0 | 14.8 | | | | 15.5 | 5 | 5 | 140 | 130 | 53385KP[1]4T0 | | |
| 3.9 | 585.0 | 15.1 | | | | 15.8 | 5 | 5 | 160 | 145 | 53985KP[1]4T0 | | |
| 4.7 | 705.0 | 16.5 | | | | 17.4 | 5 | 5 | 185 | 170 | 54785KP[1]5T0 | | |

Notes

- (1) I_{RMS} at 85 °C ambient temperature and 100 kHz
- (2) ESR at 85 °C and 100 kHz
- (3) Maximum tan δ value at 100 kHz
- (4) Please replace "[1]" by the lead length code and the "[2]" by the packaging type in accordance with section "Composition of Catalog Number"



| ELECTRICAL DATA AND ORDERING CODE | | | | | | | | | | | | | |
|---|------------------|--------------------------------|--------------------|------------|------------------------------|--------------------------|--|-----------|----------------------------|-----------------|---|---------------|---|
| U _{RDC} (V) | CAP. (μF) | DIMENSION w x h x l (mm) | P1 (mm) | P2 (mm) | du/dt (V/μs) _R | I _{PEAK} (A) | I _{RMS} ⁽¹⁾ (A) | | ESR ⁽²⁾ (mΩ) | | tan δ ⁽³⁾ (10 ⁻⁴) | | ORDERING CODE ⁽⁴⁾ MKP385e.... |
| | | | | | | | 2 PINS | 4 PINS | 2 PINS | 4 PINS | 2 PINS | 4 PINS | |
| U_{RAC} = 350 V, U_{p-p} = 1000 V, C-TOL. = ± 10 % | | | | | | | | | | | | | |
| 1000 | 0.018 | 7.0 x 13.5 x 17.5 | 15 | - | 590 | 10.6 | 1.1 | - | 175 | - | 30 | - | 31810KF[1]2[2]0 |
| | 0.022 | | | | | 13.0 | 1.2 | - | 143 | - | 30 | - | 32210KF[1]2[2]0 |
| | 0.027 | | | | | 15.9 | 1.3 | - | 117 | - | 30 | - | 32710KF[1]2[2]0 |
| | 0.033 | 8.5 x 15.0 x 17.5 | | | | 19.5 | 1.6 | - | 95 | - | 30 | - | 33310KF[1]2[2]0 |
| | 0.039 | | | | | 23.0 | 1.7 | - | 81 | - | 30 | - | 33910KF[1]2[2]0 |
| | 0.047 | | | | | 27.7 | 1.9 | - | 67 | - | 30 | - | 34710KF[1]2[2]0 |
| | 0.056 | 10.0 x 16.5 x 17.5 | | | | 33.0 | 2.1 | - | 66 | - | 35 | - | 35610KF[1]2[2]0 |
| | 0.068 | | | | | 40.1 | 2.3 | - | 54 | - | 35 | - | 36810KF[1]2[2]0 |
| | 0.082 | | | | | 48.4 | 2.3 | - | 58 | - | 45 | - | 38210KF[1]2[2]0 |
| | 0.056 | 7.0 x 16.5 x 26.0 | 22.5 | - | 530 | 29.7 | 2.0 | - | 66 | - | 35 | - | 35610KI[1]2[2]0 |
| | 0.068 | 8.5 x 18.0 x 26.0 | | | | 36.0 | 2.4 | - | 54 | - | 35 | - | 36810KI[1]2[2]0 |
| | 0.082 | | | | | 43.5 | 2.3 | - | 58 | - | 45 | - | 38210KI[1]2[2]0 |
| | 0.10 | | | | | 10.0 x 19.5 x 26.0 | 53.0 | 2.7 | - | 47 | - | 45 | - |
| | 0.12 | 63.6 | | | | | 3.0 | - | 39 | - | 45 | - | 41210KI[1]2[2]0 |
| | 0.15 | 79.5 | | | | | 3.6 | - | 32 | - | 45 | - | 41510KI[1]2[2]0 |
| | 0.18 | 12.0 x 22.0 x 26.0 | | | | 95.4 | 4.0 | - | 26 | - | 45 | - | 41810KI[1]2[2]0 |
| | 0.22 | | | | | 116.6 | 3.4 | - | 36 | - | 75 | - | 42210KI[1]2[2]0 |
| | 0.10 | | | | | 9.0 x 19.0 x 31.0 | 33.0 | 2.6 | - | 47 | - | 45 | - |
| | 0.12 | 39.6 | 2.8 | - | 39 | | - | 45 | - | 41210KK[1]2[2]0 | | | |
| | 0.15 | 49.5 | 3.4 | - | 32 | | - | 45 | - | 41510KK[1]2[2]0 | | | |
| | 0.18 | 11.0 x 21.0 x 31.0 | 59.4 | 3.7 | - | 26 | - | 45 | - | 41810KK[1]2[2]0 | | | |
| | 0.22 | | 72.6 | 3.2 | - | 36 | - | 75 | - | 42210KK[1]2[2]0 | | | |
| | 0.27 | | 89.1 | 3.8 | - | 29 | - | 75 | - | 42710KK[1]2[2]0 | | | |
| | 0.33 | 13.0 x 23.0 x 31.0 | 108.9 | 4.2 | - | 24 | - | 75 | - | 43310KK[1]2[2]0 | | | |
| | 0.39 | | 128.7 | 4.9 | - | 20 | - | 75 | - | 43910KK[1]2[2]0 | | | |
| | 0.47 | | 155.1 | 5.4 | - | 17 | - | 75 | - | 44710KK[1]2[2]0 | | | |
| | 0.56 | 18.0 x 28.0 x 31.0 | 184.8 | 5.6 | - | 19 | - | 100 | - | 45610KK[1]2[2]0 | | | |
| | 0.68 | 21.0 x 31.0 x 31.0 | 224.4 | 5.1 | - | 15 | - | 100 | - | 46810KK[1]2[2]0 | | | |
| | 0.82 | | 270.6 | 5.3 | - | 14 | - | 110 | - | 48210KK[1]2[2]0 | | | |
| | 1.0 | | 15.7 x 28.5 x 41.5 | 180.0 | 9.6 | - | 7 | - | 60 | - | 51010KP[1]2T0 | | |
| 1.2 | 18 x 32.5 x 41.5 | 216.0 | 10.9 | - | 7 | - | 65 | - | 51210KP[1]2T0 | | | | |
| 1.5 | 18.5 x 35.5 x 43 | 37.5 | - | 180 | 270.0 | 12.2 | 12.8 | 6 | 6 | 75 | 70 | 51510KP[1]4T0 | |
| 1.8 | 21.5 x 38.5 x 43 | | | | 324.0 | 13.5 | 14.2 | 6 | 6 | 80 | 75 | 51810KP[1]4T0 | |
| 2.2 | 24 x 44 x 42 | | | | 396.0 | 15.1 | 15.8 | 5 | 5 | 90 | 85 | 52210KP[1]4T0 | |
| 2.7 | | | | | 486.0 | 15.6 | 16.4 | 5 | 5 | 105 | 95 | 52710KP[1]4T0 | |
| 3.3 | | | | | 594.0 | 17.1 | 18.0 | 5 | 5 | 120 | 110 | 53310KP[1]5T0 | |
| | 30 x 45 x 42 | | | | | 10.2 | | | | | | | |
| | | | 20.3 | | | | | | | | | | |

Notes

- (1) I_{RMS} at 85 °C ambient temperature and 100 kHz
- (2) ESR at 85 °C and 100 kHz
- (3) Maximum tan δ value at 100 kHz
- (4) Please replace "[1]" by the lead length code and the "[2]" by the packaging type in accordance with section "Composition of Catalog Number"



| ELECTRICAL DATA AND ORDERING CODE | | | | | | | | | | | | | |
|---|--------------|--------------------------------|------------|------------|------------------------------|--------------------------|--|-----------|----------------------------|-----------|---|-----------|---|
| U _{RDC} (V) | CAP. (μF) | DIMENSION w x h x l (mm) | P1 (mm) | P2 (mm) | du/dt (V/μs) _R | I _{PEAK} (A) | I _{RMS} ⁽¹⁾ (A) | | ESR ⁽²⁾ (mΩ) | | tan δ ⁽³⁾ (10 ⁻⁴) | | ORDERING CODE ⁽⁴⁾ MKP385e.... |
| | | | | | | | 2 PINS | 4 PINS | 2 PINS | 4 PINS | 2 PINS | 4 PINS | |
| U_{RAC} = 450 V, U_{p-p} = 1250 V, C-TOL. = ± 10 % | | | | | | | | | | | | | |
| 1250 | 0.0082 | 7.0 x 13.5 x 17.5 | 15 | - | 670 | 5.5 | 0.8 | - | 320 | - | 25 | - | 28212KF[1]2[2]0 |
| | 0.010 | | | | | 6.7 | 0.9 | - | 263 | - | 25 | - | 31012KF[1]2[2]0 |
| | 0.012 | | | | | 8.0 | 1.0 | - | 219 | - | 25 | - | 31212KF[1]2[2]0 |
| | 0.015 | | | | | 10.1 | 1.1 | - | 175 | - | 25 | - | 31512KF[1]2[2]0 |
| | 0.018 | | | | | 12.1 | 1.2 | - | 146 | - | 25 | - | 31812KF[1]2[2]0 |
| | 0.022 | | | | | 14.7 | 1.4 | - | 119 | - | 25 | - | 32212KF[1]2[2]0 |
| | 0.027 | 8.5 x 15.0 x 17.5 | 15 | - | 670 | 18.1 | 1.4 | - | 117 | - | 30 | - | 32712KF[1]2[2]0 |
| | 0.033 | | | | | 22.1 | 1.6 | - | 95 | - | 30 | - | 33312KF[1]2[2]0 |
| | 0.039 | | | | | 26.1 | 1.9 | - | 81 | - | 30 | - | 33912KF[1]2[2]0 |
| | 0.047 | 10.0 x 16.5 x 17.5 | 15 | - | 670 | 31.5 | 2.1 | - | 67 | - | 30 | - | 34712KF[1]2[2]0 |
| | 0.056 | | | | | 37.5 | 2.2 | - | 66 | - | 35 | - | 35612KF[1]2[2]0 |
| | 0.068 | 11.0 x 18.5 x 18.0 | 15 | - | 670 | 45.6 | 2.5 | - | 54 | - | 35 | - | 36812KF[1]2[2]0 |
| | 0.047 | 8.5 x 18.0 x 26.0 | 22.5 | - | 600 | 28.2 | 2.1 | - | 67 | - | 30 | - | 34712KI[1]2[2]0 |
| | 0.056 | | | | | 33.6 | 2.1 | - | 66 | - | 35 | - | 35612KI[1]2[2]0 |
| | 0.068 | | | | | 40.8 | 2.4 | - | 54 | - | 35 | - | 36812KI[1]2[2]0 |
| | 0.082 | 10.0 x 19.5 x 26.0 | 22.5 | - | 600 | 49.2 | 2.5 | - | 58 | - | 45 | - | 38212KI[1]2[2]0 |
| | 0.10 | | | | | 60.0 | 2.7 | - | 47 | - | 45 | - | 41012KI[1]2[2]0 |
| | 0.12 | 12.0 x 22.0 x 26.0 | 22.5 | - | 600 | 72.0 | 3.2 | - | 39 | - | 45 | - | 41212KI[1]2[2]0 |
| | 0.15 | 12.5 x 22.5 x 26.5 | 22.5 | - | 600 | 90.0 | 3.6 | - | 32 | - | 45 | - | 41512KI[1]2[2]0 |
| | 0.18 | | | | | 108.0 | 4.1 | - | 26 | - | 45 | - | 41812KI[1]2[2]0 |
| | 0.10 | 9.0 x 19.0 x 31.0 | 27.5 | - | 370 | 37.0 | 2.6 | - | 47 | - | 45 | - | 41012KK[1]2[2]0 |
| | 0.12 | 11.0 x 21.0 x 31.0 | | | | 44.4 | 3.1 | - | 39 | - | 45 | - | 41212KK[1]2[2]0 |
| | 0.15 | 13.0 x 23.0 x 31.0 | | | | 55.5 | 3.4 | - | 32 | - | 45 | - | 41512KK[1]2[2]0 |
| | 0.18 | 15.0 x 25.0 x 31.0 | | | | 66.6 | 4.0 | - | 26 | - | 45 | - | 41812KK[1]2[2]0 |
| | 0.22 | 18.0 x 28.0 x 31.0 | | | | 81.4 | 3.4 | - | 36 | - | 75 | - | 42212KK[1]2[2]0 |
| | 0.27 | 21.0 x 31.0 x 31.0 | | | | 99.9 | 4.1 | - | 29 | - | 75 | - | 42712KK[1]2[2]0 |
| | 0.33 | 18.0 x 28.0 x 31.0 | 27.5 | - | 370 | 122.1 | 4.5 | - | 24 | - | 75 | - | 43312KK[1]2[2]0 |
| | 0.39 | | | | | 144.3 | 5.4 | - | 20 | - | 75 | - | 43912KK[1]2[2]0 |
| | 0.47 | 21.0 x 31.0 x 31.0 | 27.5 | - | 370 | 173.9 | 5.9 | - | 17 | - | 75 | - | 44712KK[1]2[2]0 |
| | 0.56 | | | | | 207.2 | 6.0 | - | 19 | - | 100 | - | 45612KK[1]2[2]0 |
| | 0.82 | 18 x 32.5 x 41.5 | 37.5 | - | 200 | 164.0 | 13.3 | - | 5 | - | 30 | - | 48212KP[1]2T0 |
| | 1.0 | | | | | 200.0 | 12.1 | - | 6 | - | 45 | - | 51012KP[1]2T0 |
| | 1.2 | 18.5 x 35.5 x 43 | 37.5 | 10.2 | 200 | 240.0 | 12.2 | 12.8 | 6 | 6 | 60 | 55 | 51212KP[1]4T0 |
| | 1.5 | 21.5 x 38.5 x 43 | | | | 300.0 | 13.0 | 13.6 | 6 | 6 | 75 | 70 | 51512KP[1]4T0 |
| | 1.8 | 24 x 44 x 42 | 37.5 | 20.3 | 200 | 360.0 | 14.3 | 15.1 | 6 | 6 | 85 | 80 | 51812KP[1]4T0 |
| | 2.2 | 30 x 45 x 42 | | | | 440.0 | 16.7 | 17.5 | 5 | 5 | 85 | 80 | 52212KP[1]5T0 |
| 2.7 | 540.0 | | 18.4 | 19.3 | 5 | 5 | 100 | 90 | 52712KP[1]5T0 | | | | |

Notes

- (1) I_{RMS} at 85 °C ambient temperature and 100 kHz
- (2) ESR at 85 °C and 100 kHz
- (3) Maximum tan δ value at 100 kHz
- (4) Please replace "[1]" by the lead length code and the "[2]" by the packaging type in accordance with section "Composition of Catalog Number"



| ELECTRICAL DATA AND ORDERING CODE | | | | | | | | | | | | | | | | | |
|---|--------------|--------------------------------|------------|------------|------------------------------|--------------------------|--|-----------|----------------------------|-----------------|---|-----------|---|-----------------|----|----|---------------|
| U _{RDC} (V) | CAP. (μF) | DIMENSION w x h x l (mm) | P1 (mm) | P2 (mm) | du/dt (V/μs) _R | I _{PEAK} (A) | I _{RMS} ⁽¹⁾ (A) | | ESR ⁽²⁾ (mΩ) | | tan δ ⁽³⁾ (10 ⁻⁴) | | ORDERING CODE ⁽⁴⁾ MKP385e.... | | | | |
| | | | | | | | 2 PINS | 4 PINS | 2 PINS | 4 PINS | 2 PINS | 4 PINS | | | | | |
| U_{RAC} = 550 V, U_{p-p} = 1600 V, C-TOL. = ± 10 % | | | | | | | | | | | | | | | | | |
| 1600 | 0.0039 | 7.0 x 13.5 x 17.5 | 15 | - | 2000 | 7.8 | 0.6 | - | 539 | - | 20 | - | 2391AKF[1]2[2]0 | | | | |
| | 0.0047 | | | | | 9.4 | 0.7 | - | 447 | - | 20 | - | 2471AKF[1]2[2]0 | | | | |
| | 0.0056 | | | | | 11.2 | 0.7 | - | 375 | - | 20 | - | 2561AKF[1]2[2]0 | | | | |
| | 0.0068 | | | | | 13.6 | 0.8 | - | 309 | - | 20 | - | 2681AKF[1]2[2]0 | | | | |
| | 0.0082 | | | | | 16.4 | 0.9 | - | 256 | - | 20 | - | 2821AKF[1]2[2]0 | | | | |
| | 0.010 | | | | | 20.0 | 0.9 | - | 263 | - | 25 | - | 3101AKF[1]2[2]0 | | | | |
| | 0.012 | | | | | 24.0 | 1.0 | - | 219 | - | 25 | - | 3121AKF[1]2[2]0 | | | | |
| | 0.015 | | | | | 8.5 x 15.0 x 17.5 | 30.0 | 1.2 | - | 175 | - | 25 | - | 3151AKF[1]2[2]0 | | | |
| | 0.018 | | | | | | 36.0 | 1.3 | - | 146 | - | 25 | - | 3181AKF[1]2[2]0 | | | |
| | 0.022 | | | | | 10.0 x 16.5 x 17.5 | 44.0 | 1.6 | - | 119 | - | 25 | - | 3221AKF[1]2[2]0 | | | |
| | 0.027 | 54.0 | 1.6 | - | 117 | | - | 30 | - | 3271AKF[1]2[2]0 | | | | | | | |
| | 0.033 | 10.5 x 17.5 x 18.0 | 66.0 | 1.8 | - | 95 | - | 30 | - | 3331AKF[1]2[2]0 | | | | | | | |
| | 0.039 | 11.0 x 18.5 x 18.0 | 78.0 | 2.0 | - | 81 | - | 30 | - | 3391AKF[1]2[2]0 | | | | | | | |
| | 0.010 | 7.0 x 16.5 x 26.0 | 22.5 | - | 1700 | 17.0 | 1.0 | - | 263 | - | 25 | - | 3101AKI[1]2[2]0 | | | | |
| | 0.012 | | | | | 20.4 | 1.2 | - | 219 | - | 25 | - | 3121AKI[1]2[2]0 | | | | |
| | 0.015 | | | | | 25.5 | 1.3 | - | 175 | - | 25 | - | 3151AKI[1]2[2]0 | | | | |
| | 0.018 | | | | | 30.6 | 1.4 | - | 146 | - | 25 | - | 3181AKI[1]2[2]0 | | | | |
| | 0.022 | | | | | 37.4 | 1.6 | - | 119 | - | 25 | - | 3221AKI[1]2[2]0 | | | | |
| | 0.027 | | | | | 45.9 | 1.6 | - | 117 | - | 30 | - | 3271AKI[1]2[2]0 | | | | |
| | 0.033 | | | | | 56.1 | 1.8 | - | 95 | - | 30 | - | 3331AKI[1]2[2]0 | | | | |
| | 0.039 | | | | | 66.3 | 1.9 | - | 81 | - | 30 | - | 3391AKI[1]2[2]0 | | | | |
| | 0.047 | | | | | 10.0 x 19.5 x 26.0 | 79.9 | 2.3 | - | 67 | - | 30 | - | 3471AKI[1]2[2]0 | | | |
| | 0.056 | | | | | | 95.2 | 2.3 | - | 66 | - | 35 | - | 3561AKI[1]2[2]0 | | | |
| | 0.068 | 12.0 x 22.0 x 26.0 | 115.6 | 2.8 | - | 54 | - | 35 | - | 3681AKI[1]2[2]0 | | | | | | | |
| | 0.082 | | 139.4 | 2.7 | - | 58 | - | 45 | - | 3821AKI[1]2[2]0 | | | | | | | |
| | 0.10 | | 170.0 | 3.0 | - | 47 | - | 45 | - | 4101AKI[1]2[2]0 | | | | | | | |
| | 0.068 | | 81.6 | 2.3 | - | 70 | - | 45 | - | 3681AKK[1]2[2]0 | | | | | | | |
| | 0.082 | 11.0 x 21.0 x 31.0 | 27.5 | - | 1200 | 98.4 | 2.5 | - | 58 | - | 45 | - | 3821AKK[1]2[2]0 | | | | |
| | 0.10 | | | | | 120.0 | 2.8 | - | 47 | - | 45 | - | 4101AKK[1]2[2]0 | | | | |
| | 0.12 | | | | | 144.0 | 3.3 | - | 39 | - | 45 | - | 4121AKK[1]2[2]0 | | | | |
| | 0.15 | | | | | 180.0 | 3.9 | - | 32 | - | 45 | - | 4151AKK[1]2[2]0 | | | | |
| | 0.18 | | | | | 216.0 | 4.3 | - | 26 | - | 45 | - | 4181AKK[1]2[2]0 | | | | |
| | 0.22 | | | | | 264.0 | 4.0 | - | 36 | - | 75 | - | 4221AKK[1]2[2]0 | | | | |
| | 0.27 | | | | | 324.0 | 4.5 | - | 29 | - | 75 | - | 4271AKK[1]2[2]0 | | | | |
| | 0.33 | | | | | 396.0 | 5.3 | - | 24 | - | 75 | - | 4331AKK[1]2[2]0 | | | | |
| | 0.47 | | | | | 18 x 32.5 x 41.5 | 37.5 | - | 450 | 211.5 | 11.2 | - | 6 | - | 25 | - | 4471AKP[1]2T0 |
| | 0.56 | | | | | | | | | 252.0 | 12.7 | 13.3 | 6 | 6 | 25 | 25 | 4561AKP[1]4T0 |
| | 0.68 | 306.0 | 14.3 | 15.0 | 5 | | | | | 5 | 30 | 30 | 4681AKP[1]4T0 | | | | |
| | 0.82 | 369.0 | 15.8 | 16.6 | 5 | | | | | 5 | 35 | 35 | 4821AKP[1]4T0 | | | | |
| | 1.00 | 450.0 | 15.8 | 16.6 | 5 | | | | | 5 | 40 | 40 | 5101AKP[1]4T0 | | | | |
| | 1.20 | 540.0 | 16.6 | 17.4 | 5 | | | | | 5 | 50 | 45 | 5121AKP[1]5T0 | | | | |

Notes

- (1) I_{RMS} at 85 °C ambient temperature and 100 kHz
- (2) ESR at 85 °C and 100 kHz
- (3) Maximum tan δ value at 100 kHz
- (4) Please replace "[1]" by the lead length code and the "[2]" by the packaging type in accordance with section "Composition of Catalog Number"



| ELECTRICAL DATA AND ORDERING CODE | | | | | | | | | | | | | |
|---|------------------|--------------------------------|------------|------------|------------------------------|--------------------------|--|-----------------|----------------------------|-----------|---|-----------------|---|
| U _{RDC} (V) | CAP. (μF) | DIMENSION w x h x l (mm) | P1 (mm) | P2 (mm) | du/dt (V/μs) _R | I _{PEAK} (A) | I _{RMS} ⁽¹⁾ (A) | | ESR ⁽²⁾ (mΩ) | | tan δ ⁽³⁾ (10 ⁻⁴) | | ORDERING CODE ⁽⁴⁾ MKP385e.... |
| | | | | | | | 2 PINS | 4 PINS | 2 PINS | 4 PINS | 2 PINS | 4 PINS | |
| U_{RAC} = 700 V, U_{p-p} = 2000 V, C-TOL. = ± 10 % | | | | | | | | | | | | | |
| 2000 | 0.0010 | 7.0 x 13.5 x 17.5 | 15 | - | 2900 | 2.9 | 0.3 | - | 2626 | - | 25 | - | 2102AKF[1]2[2]0 |
| | 0.0012 | | | | | 3.5 | 0.3 | - | 2188 | - | 25 | - | 2122AKF[1]2[2]0 |
| | 0.0015 | | | | | 4.4 | 0.3 | - | 1751 | - | 25 | - | 2152AKF[1]2[2]0 |
| | 0.0018 | | | | | 5.2 | 0.4 | - | 1459 | - | 25 | - | 2182AKF[1]2[2]0 |
| | 0.0022 | | | | | 6.4 | 0.4 | - | 1194 | - | 25 | - | 2222AKF[1]2[2]0 |
| | 0.0027 | | | | | 7.8 | 0.5 | - | 973 | - | 25 | - | 2272AKF[1]2[2]0 |
| | 0.0033 | | | | | 9.6 | 0.5 | - | 796 | - | 25 | - | 2332AKF[1]2[2]0 |
| | 0.0039 | | | | | 11.3 | 0.6 | - | 673 | - | 25 | - | 2392AKF[1]2[2]0 |
| | 0.0047 | | | | | 13.6 | 0.6 | - | 559 | - | 25 | - | 2472AKF[1]2[2]0 |
| | 0.0056 | | | | | 16.2 | 0.7 | - | 469 | - | 25 | - | 2562AKF[1]2[2]0 |
| | 0.0068 | 19.7 | 0.8 | - | 386 | - | 25 | - | 2682AKF[1]2[2]0 | | | | |
| | 0.0082 | 8.5 x 15.0 x 17.5 | 22.5 | - | 2500 | 23.8 | 0.9 | - | 320 | - | 25 | - | 2822AKF[1]2[2]0 |
| | 0.010 | 29.0 | | | | 1.0 | - | 263 | - | 25 | - | 3102AKF[1]2[2]0 | |
| | 0.012 | 34.8 | | | | 1.0 | - | 263 | - | 30 | - | 3122AKF[1]2[2]0 | |
| | 0.015 | 43.5 | | | | 1.2 | - | 210 | - | 30 | - | 3152AKF[1]2[2]0 | |
| | 0.018 | 52.2 | | | | 1.3 | - | 175 | - | 30 | - | 3182AKF[1]2[2]0 | |
| | 0.022 | 63.8 | | | | 1.5 | - | 143 | - | 30 | - | 3222AKF[1]2[2]0 | |
| | 0.010 | 25.0 | | | | 1.1 | - | 263 | - | 25 | - | 3102AKI[1]2[2]0 | |
| | 0.012 | 30.0 | | | | 1.1 | - | 263 | - | 30 | - | 3122AKI[1]2[2]0 | |
| | 0.015 | 37.5 | | | | 1.2 | - | 210 | - | 30 | - | 3152AKI[1]2[2]0 | |
| | 0.018 | 45.0 | | | | 1.3 | - | 175 | - | 30 | - | 3182AKI[1]2[2]0 | |
| | 0.022 | 55.0 | 1.5 | - | 143 | - | 30 | - | 3222AKI[1]2[2]0 | | | | |
| | 0.027 | 67.5 | 1.7 | - | 117 | - | 30 | - | 3272AKI[1]2[2]0 | | | | |
| | 0.033 | 82.5 | 1.9 | - | 95 | - | 30 | - | 3332AKI[1]2[2]0 | | | | |
| | 0.039 | 97.5 | 2.3 | - | 81 | - | 30 | - | 3392AKI[1]2[2]0 | | | | |
| | 0.047 | 117.5 | 2.5 | - | 67 | - | 30 | - | 3472AKI[1]2[2]0 | | | | |
| | 0.056 | 140.0 | 2.5 | - | 66 | - | 35 | - | 3562AKI[1]2[2]0 | | | | |
| | 0.022 | 37.4 | 1.6 | - | 143 | - | 30 | - | 3222AKK[1]2[2]0 | | | | |
| 0.027 | 45.9 | 1.8 | - | 117 | - | 30 | - | 3272AKK[1]2[2]0 | | | | | |
| 0.033 | 56.1 | 2.0 | - | 95 | - | 30 | - | 3332AKK[1]2[2]0 | | | | | |
| 0.039 | 66.3 | 2.1 | - | 81 | - | 30 | - | 3392AKK[1]2[2]0 | | | | | |
| 0.047 | 79.9 | 2.3 | - | 67 | - | 30 | - | 3472AKK[1]2[2]0 | | | | | |
| 0.056 | 95.2 | 2.5 | - | 66 | - | 35 | - | 3562AKK[1]2[2]0 | | | | | |
| 0.068 | 115.6 | 2.8 | - | 54 | - | 35 | - | 3682AKK[1]2[2]0 | | | | | |
| 0.082 | 139.4 | 2.9 | - | 58 | - | 45 | - | 3822AKK[1]2[2]0 | | | | | |
| 0.10 | 170.0 | 3.2 | - | 47 | - | 45 | - | 4102AKK[1]2[2]0 | | | | | |
| 0.12 | 204.0 | 3.8 | - | 39 | - | 45 | - | 4122AKK[1]2[2]0 | | | | | |
| 0.15 | 255.0 | 4.3 | - | 32 | - | 45 | - | 4152AKK[1]2[2]0 | | | | | |
| 0.18 | 306.0 | 5.1 | - | 26 | - | 45 | - | 4182AKK[1]2[2]0 | | | | | |
| 0.33 | 18.5 x 35.5 x 43 | 37.5 | 10.2 | 600 | 198.0 | 11.8 | 12.4 | 7 | 7 | 20 | 20 | 4332AKP[1]4T0 | |
| 0.39 | 21.5 x 38.5 x 43 | | | | 234.0 | 13.1 | 13.7 | 6 | 6 | 20 | 20 | 4392AKP[1]4T0 | |
| 0.47 | 24 x 44 x 42 | | | | 282.0 | 14.5 | 15.3 | 6 | 6 | 25 | 25 | 4472AKP[1]4T0 | |
| 0.56 | | | | | 336.0 | 15.0 | 15.7 | 5 | 5 | 25 | 25 | 4562AKP[1]4T0 | |
| 0.68 | 30 x 45 x 42 | | | | 408.0 | 16.6 | 17.4 | 5 | 5 | 30 | 30 | 4682AKP[1]5T0 | |

Notes

- (1) I_{RMS} at 85 °C ambient temperature and 100 kHz
- (2) ESR at 85 °C and 100 kHz
- (3) Maximum tan δ value at 100 kHz
- (4) Please replace "[1]" by the lead length code and the "[2]" by the packaging type in accordance with section "Composition of Catalog Number"



| ELECTRICAL DATA AND ORDERING CODE | | | | | | | | | | | | | | |
|---|------------------|--------------------------------|------------|------------|------------------------------|--------------------------|--|-----------|----------------------------|-----------------|---|---------------|---|-----------------|
| U _{RDC} (V) | CAP. (μF) | DIMENSION w x h x l (mm) | P1 (mm) | P2 (mm) | du/dt (V/μs) _R | I _{PEAK} (A) | I _{RMS} ⁽¹⁾ (A) | | ESR ⁽²⁾ (mΩ) | | tan δ ⁽³⁾ (10 ⁻⁴) | | ORDERING CODE ⁽⁴⁾ MKP385e.... | |
| | | | | | | | 2 PINS | 4 PINS | 2 PINS | 4 PINS | 2 PINS | 4 PINS | | |
| U_{RAC} = 800 V, U_{p-p} = 2250 V, C-TOL. = ± 10 % | | | | | | | | | | | | | | |
| 2500 | 0.0010 | 7.0 x 16.5 x 26.0 | 22.5 | - | 2500 | 2.5 | 0.3 | - | 2626 | - | 25 | - | 2102BKI[1]2[2]0 | |
| | 0.0012 | | | | | 3.0 | 0.3 | - | 2188 | - | 25 | - | 2122BKI[1]2[2]0 | |
| | 0.0015 | | | | | 8.5 x 18.0 x 26.0 | 3.8 | 0.4 | - | 1751 | - | 25 | - | 2152BKI[1]2[2]0 |
| | 0.0018 | 4.5 | | | | | 0.5 | - | 1459 | - | 25 | - | 2182BKI[1]2[2]0 | |
| | 0.0022 | 5.5 | | | | | 0.5 | - | 1194 | - | 25 | - | 2222BKI[1]2[2]0 | |
| | 0.0027 | 6.8 | | | | | 0.6 | - | 973 | - | 25 | - | 2272BKI[1]2[2]0 | |
| | 0.0033 | 8.3 | | | | | 0.6 | - | 796 | - | 25 | - | 2332BKI[1]2[2]0 | |
| | 0.0039 | 9.8 | | | | | 0.7 | - | 673 | - | 25 | - | 2392BKI[1]2[2]0 | |
| | 0.0047 | 11.8 | | | | | 0.7 | - | 559 | - | 25 | - | 2472BKI[1]2[2]0 | |
| | 0.0056 | 14.0 | | | | | 0.8 | - | 469 | - | 25 | - | 2562BKI[1]2[2]0 | |
| | 0.0068 | 10.0 x 19.5 x 26.0 | | | | | 17.0 | 0.9 | - | 386 | - | 25 | - | 2682BKI[1]2[2]0 |
| | 0.0082 | | | | | | 20.5 | 1.0 | - | 320 | - | 25 | - | 2822BKI[1]2[2]0 |
| | 0.010 | | | | | 25.0 | 1.1 | - | 263 | - | 25 | - | 3102BKI[1]2[2]0 | |
| | 0.012 | | | | | 30.0 | 1.3 | - | 263 | - | 30 | - | 3122BKI[1]2[2]0 | |
| | 0.015 | 12.0 x 22.0 x 26.0 | 37.5 | 1.4 | - | 210 | - | 30 | - | 3152BKI[1]2[2]0 | | | | |
| | 0.018 | | 45.0 | 1.6 | - | 175 | - | 30 | - | 3182BKI[1]2[2]0 | | | | |
| | 0.015 | 11.0 x 21.0 x 31.0 | 27.5 | - | 1700 | 25.5 | 1.3 | - | 210 | - | 30 | - | 3152BKK[1]2[2]0 | |
| | 0.018 | | | | | 30.6 | 1.4 | - | 175 | - | 30 | - | 3182BKK[1]2[2]0 | |
| | 0.022 | | | | | 13.0 x 23.0 x 31.0 | 37.4 | 1.7 | - | 143 | - | 30 | - | 3222BKK[1]2[2]0 |
| | 0.027 | | | | | | 45.9 | 1.9 | - | 117 | - | 30 | - | 3272BKK[1]2[2]0 |
| | 0.033 | | | | | 15.0 x 25.0 x 31.0 | 56.1 | 2.3 | - | 95 | - | 30 | - | 3332BKK[1]2[2]0 |
| | 0.039 | | | | | | 66.3 | 2.5 | - | 81 | - | 30 | - | 3392BKK[1]2[2]0 |
| | 0.047 | | | | | | 18.0 x 28.0 x 31.0 | 79.9 | 2.9 | - | 67 | - | 30 | - |
| | 0.056 | | | | | 95.2 | | 3.0 | - | 66 | - | 35 | - | 3562BKK[1]2[2]0 |
| | 0.068 | | | | | 21.0 x 31.0 x 31.0 | 115.6 | 3.5 | - | 54 | - | 35 | - | 3682BKK[1]2[2]0 |
| | 0.082 | | | | | | 139.4 | 3.4 | - | 58 | - | 45 | - | 3822BKK[1]2[2]0 |
| | 0.10 | 15.7 x 28.5 x 41.5 | 37.5 | - | 1000 | 100.0 | 7.8 | - | 11 | - | 10 | - | 4102BKP[1]2T0 | |
| | 0.12 | 18 x 32.5 x 41.5 | | | | 120.0 | 9.1 | - | 10 | - | 10 | - | 4122BKP[1]2T0 | |
| 0.15 | 18.5 x 35.5 x 43 | 150.0 | | | | 10.4 | 10.9 | 8 | 8 | 10 | 10 | 4152BKP[1]4T0 | | |
| 0.18 | 21.5 x 38.5 x 43 | 180.0 | | | | 11.9 | 12.5 | 8 | 8 | 15 | 15 | 4182BKP[1]4T0 | | |
| 0.22 | | 220.0 | | | | 12.7 | 13.3 | 6 | 6 | 15 | 15 | 4222BKP[1]4T0 | | |
| 0.27 | 24 x 44 x 42 | 270.0 | | | | 14.5 | 15.2 | 6 | 6 | 15 | 15 | 4272BKP[1]4T0 | | |
| 0.33 | 30 x 45 x 42 | 330.0 | | | | 16.4 | 17.2 | 5 | 5 | 15 | 15 | 4332BKP[1]5T0 | | |
| 0.39 | | 390.0 | | | | 17.1 | 18.0 | 5 | 5 | 15 | 15 | 4392BKP[1]5T0 | | |

Notes

- (1) I_{RMS} at 85 °C ambient temperature and 100 kHz
- (2) ESR at 85 °C and 100 kHz
- (3) Maximum tan δ value at 100 kHz
- (4) Please replace "[1]" by the lead length code and the "[2]" by the packaging type in accordance with section "Composition of Catalog Number"



| PACKAGING INFORMATION | | | | | |
|-----------------------------------|----------------------------|------------------------|-----------------------|------------------------|---------------------------------------|
| DIMENSIONS ⁽¹⁾ (mm) | MASS ⁽²⁾ (g) | d _t (mm) | SPQ (pcs) | | |
| | | | LOOSE IN BOX | | REEL PACK ⁽³⁾ |
| | | | l _t ≤ 5 mm | l _t = 25 mm | H = 18.5 mm; P ₀ = 12.7 mm |
| PITCH = 15 mm ± 0.4 mm | | | | | |
| 7.0 x 13.5 x 17.5 | 1.8 | 0.80 ± 0.08 | 750 | 500 | 800 |
| 8.5 x 15.0 x 17.5 | 2.4 | 0.80 ± 0.08 | 750 | 500 | 650 |
| 10.0 x 16.5 x 17.5 | 3 | 0.80 ± 0.08 | 500 | 450 | 600 |
| 10.5 x 17.5 x 18.0 | 4 | 0.80 ± 0.08 | 225 | 400 | 600 |
| 11.0 x 18.5 x 18.0 | 5 | 0.80 ± 0.08 | 225 | 350 | 550 |
| PITCH = 22.5 mm ± 0.4 mm | | | | | |
| 7.0 x 16.5 x 26.0 | 2.9 | 0.80 ± 0.08 | 200 | 250 | 500 |
| 8.5 x 18.0 x 26.0 | 3.8 | 0.80 ± 0.08 | 200 | 250 | 450 |
| 10.0 x 19.5 x 26.0 | 6.8 | 0.80 ± 0.08 | 200 | 200 | 350 |
| 12.0 x 22.0 x 26.0 | 7.8 | 0.80 ± 0.08 | 150 | 200 | 300 |
| 12.5 x 22.5 x 26.5 | 10 | 0.80 ± 0.08 | 140 | 400 | 300 |
| PITCH = 27.5 mm ± 0.4 mm | | | | | |
| 9.0 x 19.0 x 31.0 | 5.5 | 0.80 ± 0.08 | 100 | 150 | - |
| 11.0 x 21.0 x 31.0 | 7.4 | 0.80 ± 0.08 | 100 | 125 | - |
| 13.0 x 23.0 x 31.0 | 9.2 | 0.80 ± 0.08 | 100 | 125 | - |
| 15.0 x 25.0 x 31.0 | 12.3 | 0.80 ± 0.08 | 100 | 125 | - |
| 18.0 x 28.0 x 31.0 | 16.1 | 0.80 ± 0.08 | 100 | 100 | - |
| 21.0 x 31.0 x 31.0 | 18.3 | 0.80 ± 0.08 | 50 | 75 | - |
| PITCH = 37.5 mm ± 0.4 mm | | | | | |
| 15.7 x 28.5 x 41.5 | 17.92 | 0.95 ± 0.10 | 70 | - | - |
| 18.0 x 32.5 x 41.5 | 23.68 | 0.95 ± 0.10 | 60 | - | - |
| 18.5 x 35.5 x 43.0 | 29.41 | 0.95 ± 0.10 | 105 | - | - |
| 21.5 x 38.5 x 43.0 | 37.68 | 0.95 ± 0.10 | 91 | - | - |
| 24.0 x 44.0 x 42.0 | 47.37 | 0.95 ± 0.10 | 77 | - | - |
| 30.0 x 45.0 x 42.0 | 58.82 | 0.95 ± 0.10 | 63 | - | - |
| PITCH = 57.5 mm ± 0.4 mm | | | | | |
| 35.0 x 50.0 x 57.5 | 99.0 | 0.95 ± 0.10 | 40 | - | - |

Notes

- SPQ = Standard Packing Quantity
- (1) For tolerances see section "Space Requirements on Printed-Circuit Board"
- (2) Weight for short lead product only
- (3) H = in-tape height; P₀ = sprocket hole distance

MOUNTING**Normal Use**

The capacitors are designed for mounting on printed-circuit boards. The capacitors packed in bandoleers are designed for mounting on printed-circuit boards by means of automatic insertion machines.

For detailed tape specifications refer to packaging information www.vishay.com/doc?28139

Specific Method of Mounting to Withstand Vibration and Shock

In order to withstand vibration and shock tests, it must be ensured that the stand-off pips are in good contact with the printed-circuit board:

- For original pitch = 15 mm the capacitors shall be mechanically fixed by the leads
- For larger pitches the capacitors shall be mounted in the same way and the body clamped

Space Requirements on Printed-Circuit Board

The maximum space for length (l_{max.}), width (w_{max.}), and height (h_{max.}) of film capacitors to take in account on the printed circuit board is shown in the drawings:

For products with pitch ≤ 15 mm, Δw = Δl = 0.3 mm and Δh = 0.1 mm

For products with 15 mm < pitch ≤ 27.5 mm, Δw = Δl = 0.5 mm and Δh = 0.1 mm

For products with pitch = 37.5 mm and 52.5 mm, Δw = Δl = 0.7 mm and Δh = 0.5 mm

Eccentricity defined as in drawing. The maximum eccentricity is smaller than or equal to the lead diameter of the product concerned.

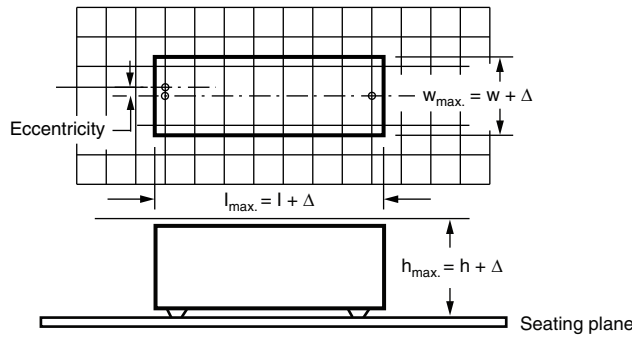

For the minimum product dimensions for length ($l_{min.}$), width ($w_{min.}$), and height ($h_{min.}$) following tolerances of the components are valid:

$l_{min.} = l - \Delta l$, $w_{min.} = w - \Delta w$, and $h_{min.} = h - \Delta h$ following

For products with pitch = 15 mm, $\Delta l = 0.5$ mm and $\Delta w = \Delta h = 0.5$ mm

For products with 15 mm < pitch < 27.5 mm, $\Delta l = 1.0$ mm and $\Delta w = \Delta h = 0.5$ mm

For products with pitch = 27.5 mm, $\Delta w = \Delta l = \Delta h = 1.0$ mm

For products with pitch = 37.5 mm and 52.5 mm. $\Delta w = \Delta l = 0.7$ mm and $\Delta h = 0.5$ mm

SOLDERING CONDITIONS

For general soldering conditions and wave soldering profile we refer to the document “Soldering Conditions Vishay Film Capacitors”: www.vishay.com/doc?28171

STORAGE TEMPERATURE

$T_{stg} = -25$ °C to $+35$ °C with RH maximum 75 % without condensation.

RATINGS AND CHARACTERISTICS REFERENCE CONDITIONS

Unless otherwise specified, all electrical values apply to an ambient free temperature of 23 °C ± 1 °C, an atmospheric pressure of 86 kPa to 106 kPa, and a relative humidity of 50 % ± 2 %.

For reference testing, a conditioning period shall be applied over 96 h ± 4 h by heating the products in a circulating air oven at the rated temperature and a relative humidity not exceeding 20 %.

CHARACTERISTICS

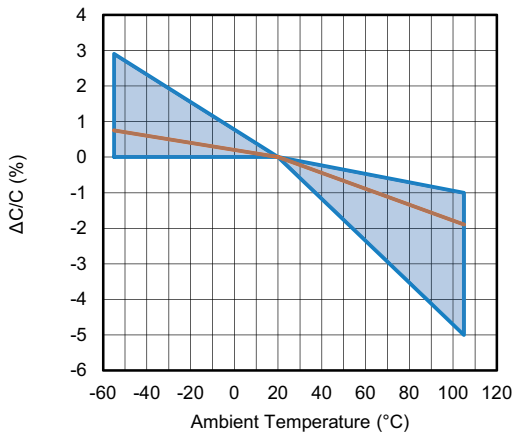

Capacitance as a function of ambient temperature (typical curve) (1 kHz)

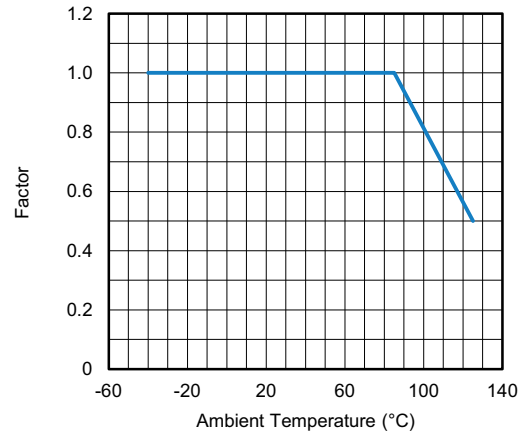

Max. DC and AC voltage as a function of temperature

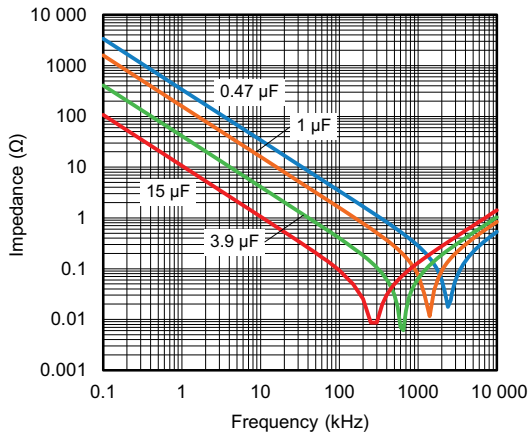

Impedance as a function of frequency (typical curve)

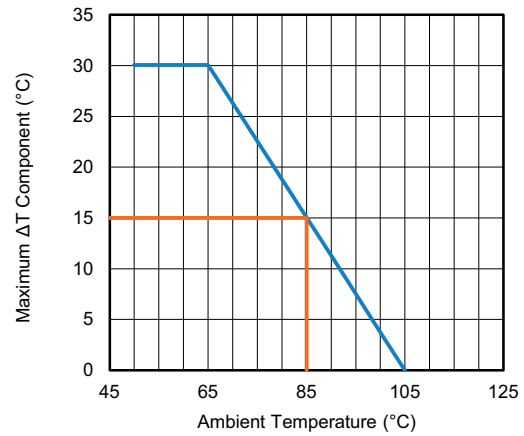

Maximum allowed component temperature rise (ΔT) as a function of ambient temperature (T_{amb})

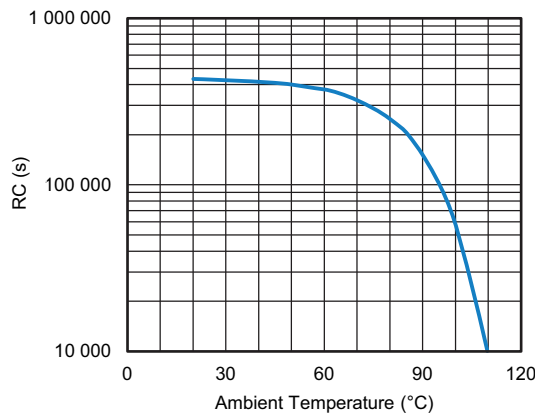

Insulation resistance as a function of ambient temperature (typical curve)

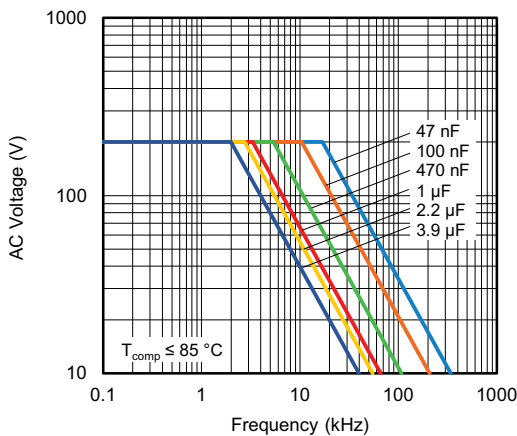

Maximum RMS voltage as a function of frequency (400 V_{DC})

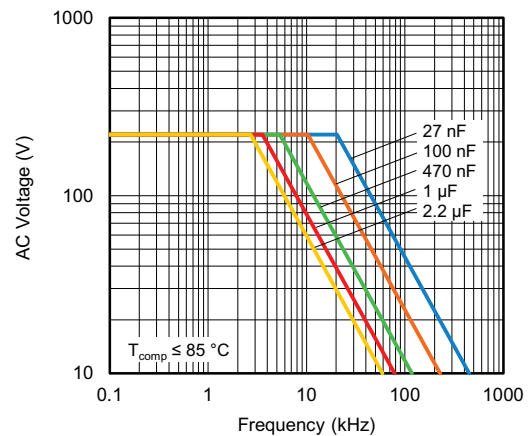

Maximum RMS voltage as a function of frequency (630 V_{DC})

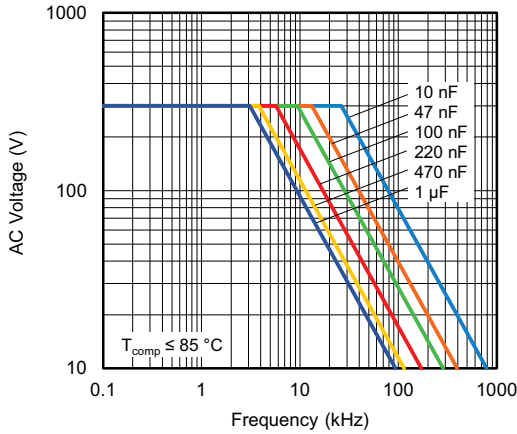

Maximum RMS voltage as a function of frequency (850 V_{DC})

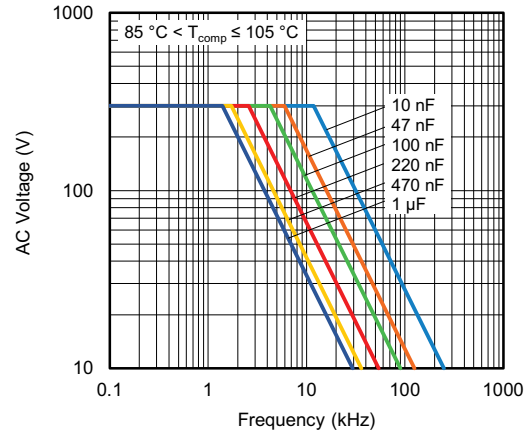

Maximum RMS voltage as a function of frequency (850 V_{DC})

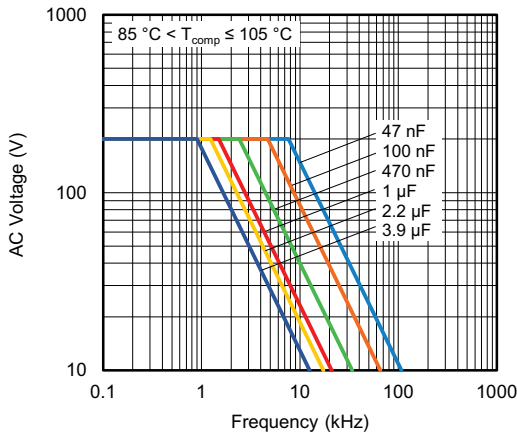

Maximum RMS voltage as a function of frequency (400 V_{DC})

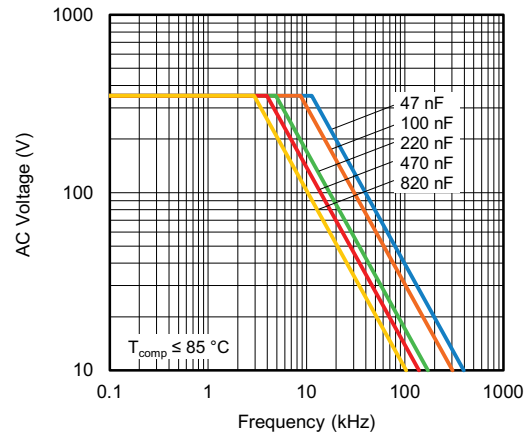

Maximum RMS voltage as a function of frequency (1000 V_{DC})

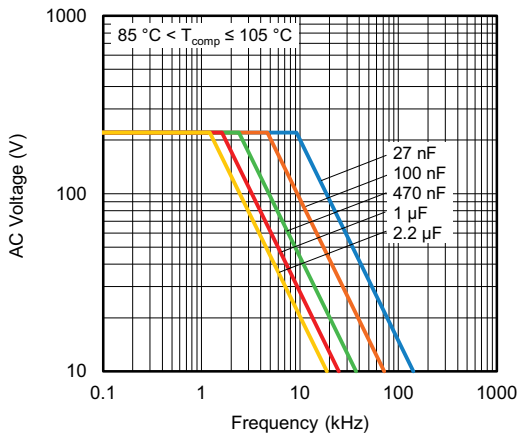

Maximum RMS voltage as a function of frequency (630 V_{DC})

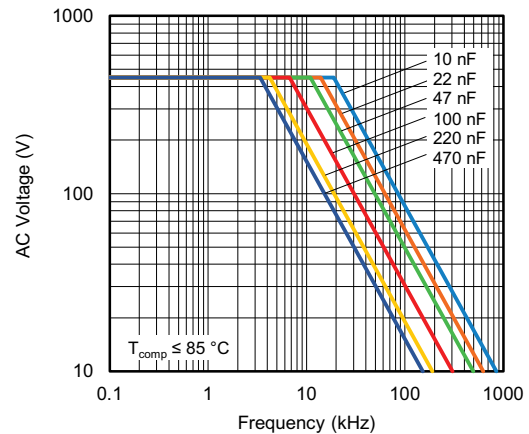

Maximum RMS voltage as a function of frequency (1250 V_{DC})

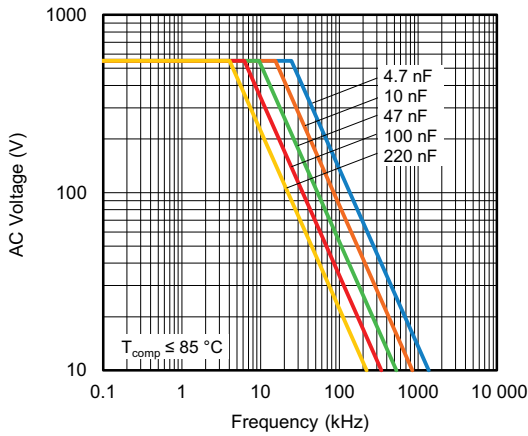

Maximum RMS voltage as a function of frequency (1600 V_{DC})

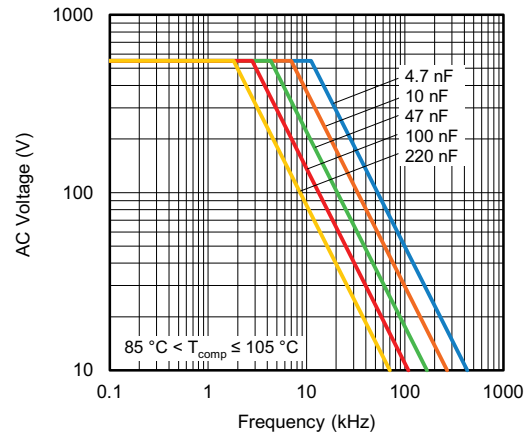

Maximum RMS voltage as a function of frequency (1600 V_{DC})

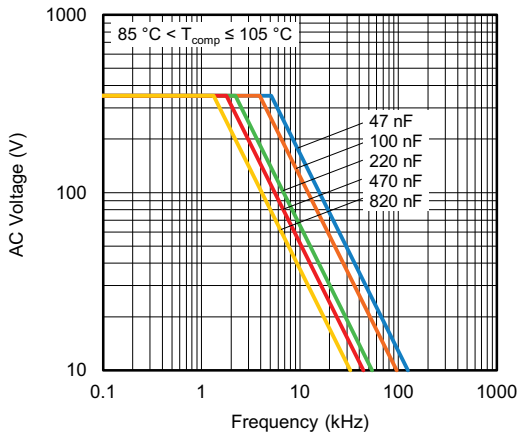

Maximum RMS voltage as a function of frequency (1000 V_{DC})

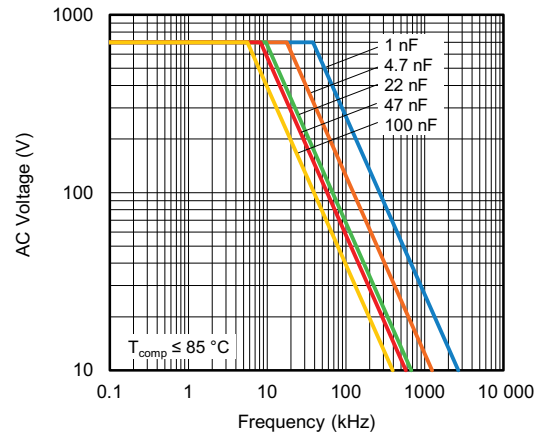

Maximum RMS voltage as a function of frequency (2000 V_{DC})

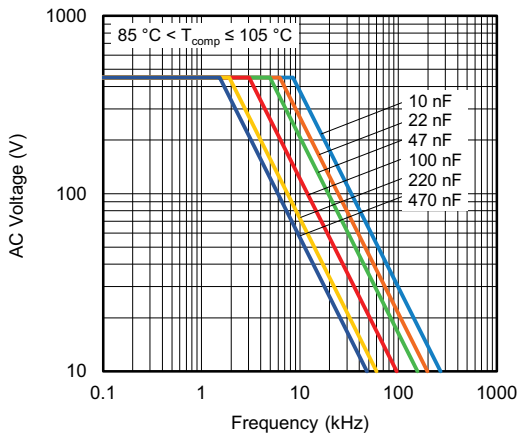

Maximum RMS voltage as a function of frequency (1250 V_{DC})

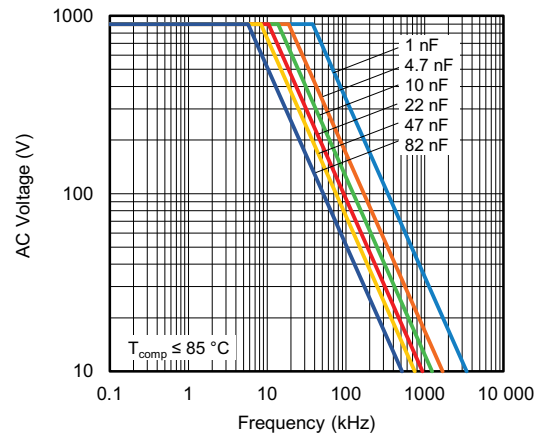

Maximum RMS voltage as a function of frequency (2500 V_{DC})

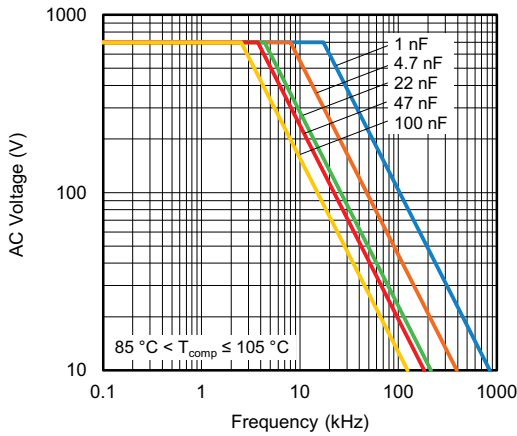

Maximum RMS voltage as a function of frequency (2000 V_{DC})

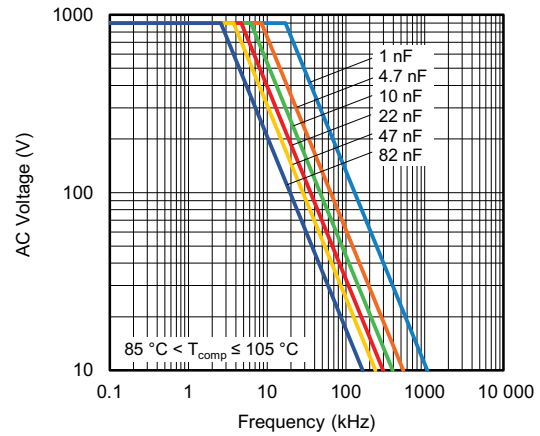

Maximum RMS voltage as a function of frequency (2500 V_{DC})

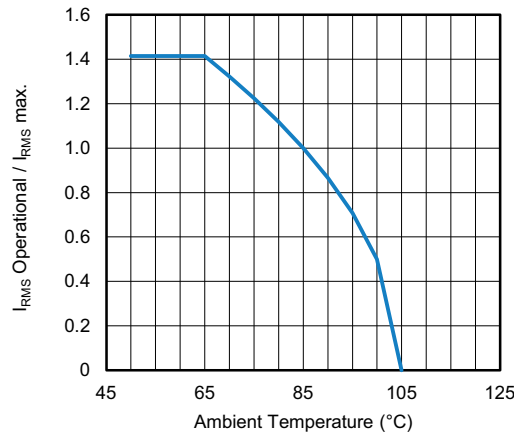

Maximum I_{RMS} current in function of the ambient temperature (typical curve)

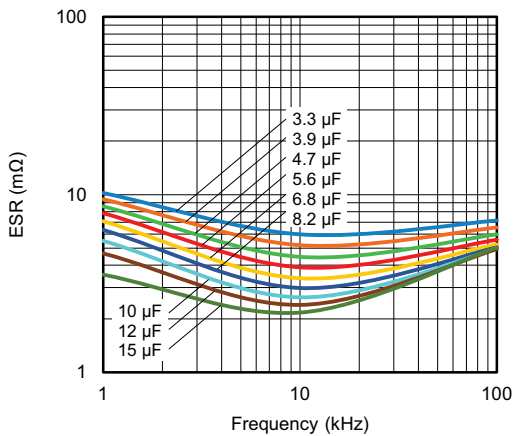

ESR as a function of frequency (400 V_{DC}) (typical curve)

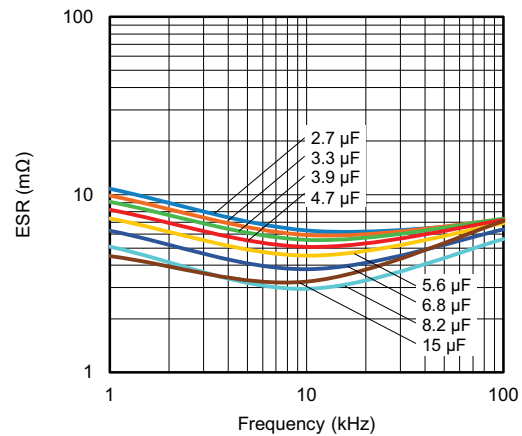

ESR as a function of frequency (630 V_{DC}) (typical curve)

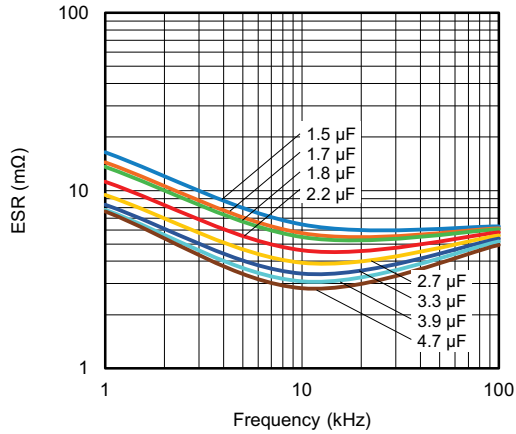

ESR as a function of frequency (850 V_{DC}) (typical curve)

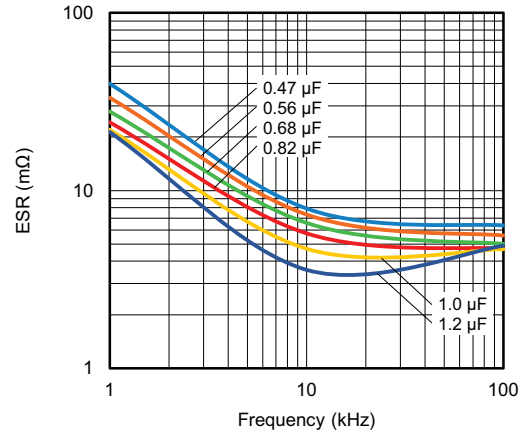

ESR as a function of frequency (1600 V_{DC}) (typical curve)

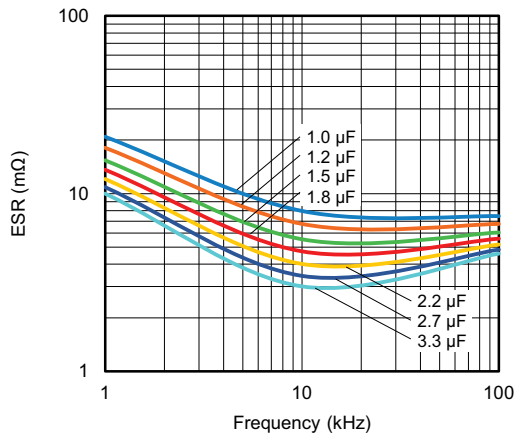

ESR as a function of frequency (1000 V_{DC}) (typical curve)

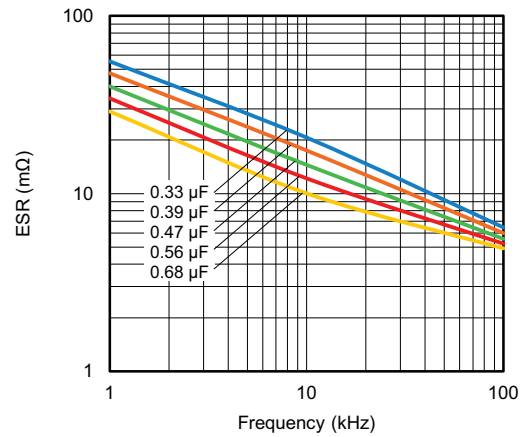

ESR as a function of frequency (2000 V_{DC}) (typical curve)

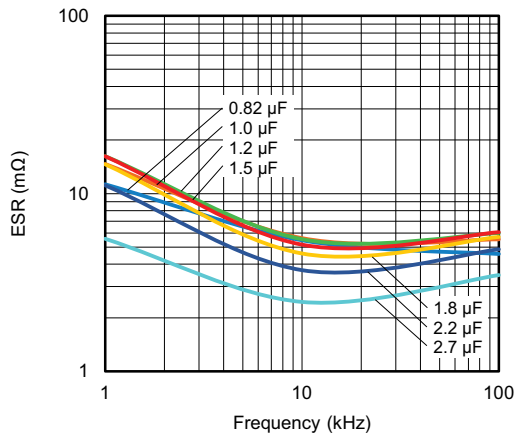

ESR as a function of frequency (1250 V_{DC}) (typical curve)

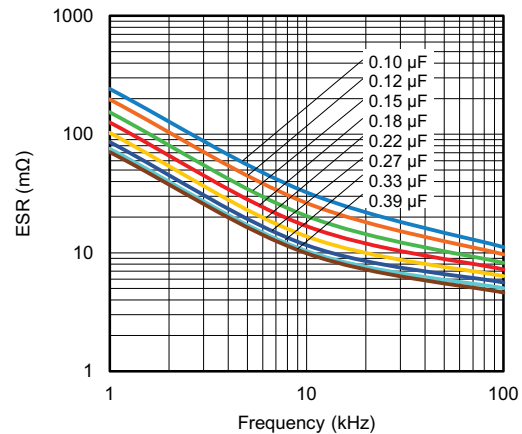

ESR as a function of frequency (2500 V_{DC}) (typical curve)

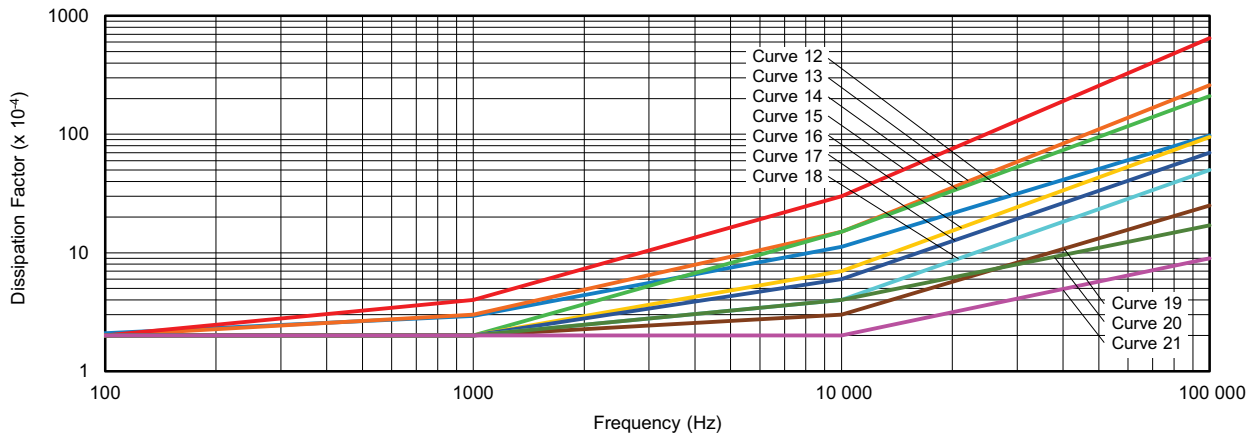
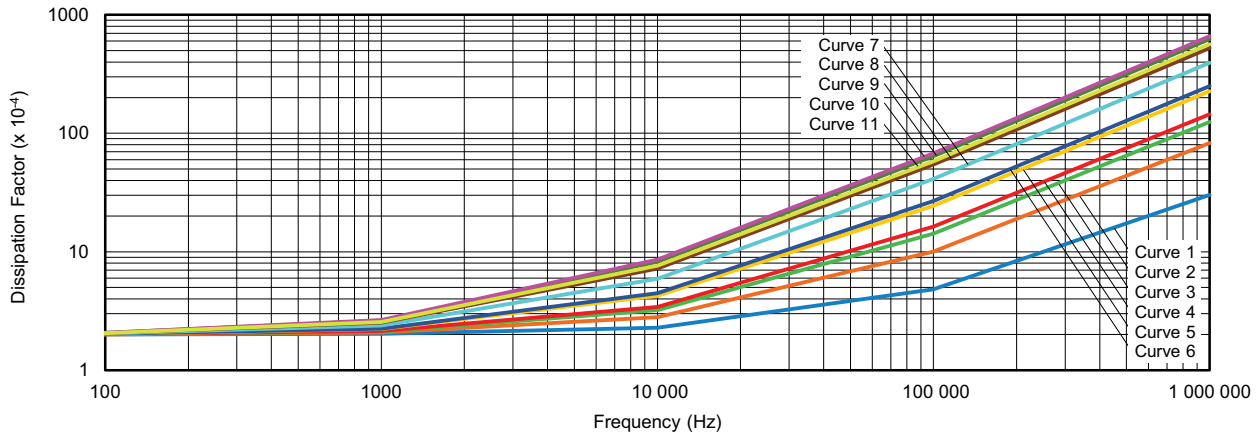

Tangent of loss angle as a function of frequency
(typical curves)

| | | | |
|--|--|--|--|
| <p>400 V: $0.047 \mu\text{F} \leq C \leq 0.068 \mu\text{F}$, curve 3 $0.082 \mu\text{F} \leq C \leq 0.18 \mu\text{F}$, curve 4 $0.22 \mu\text{F} \leq C \leq 0.39 \mu\text{F}$, curve 8 $0.47 \mu\text{F} \leq C \leq 1.2 \mu\text{F}$, curve 11 $1.5 \mu\text{F} \leq C \leq 3.9 \mu\text{F}$, curve 12 $4.7 \mu\text{F} \leq C \leq 15 \mu\text{F}$, curve 13</p> | <p>630 V: $0.027 \mu\text{F} \leq C \leq 0.033 \mu\text{F}$, curve 2 $0.039 \mu\text{F} \leq C \leq 0.1 \mu\text{F}$, curve 3 $0.12 \mu\text{F} \leq C \leq 0.24 \mu\text{F}$, curve 7 $0.27 \mu\text{F} \leq C \leq 1 \mu\text{F}$, curve 9 $1.2 \mu\text{F} \leq C \leq 2.2 \mu\text{F}$, curve 10 $2.7 \mu\text{F} \leq C \leq 8.2 \mu\text{F}$, curve 14 $15 \mu\text{F}$, curve 15</p> | <p>850 V: $0.01 \mu\text{F} \leq C \leq 0.027 \mu\text{F}$, curve 1 $0.033 \mu\text{F} \leq C \leq 0.068 \mu\text{F}$, curve 3 $0.082 \mu\text{F} \leq C \leq 0.15 \mu\text{F}$, curve 4 $0.18 \mu\text{F} \leq C \leq 0.68 \mu\text{F}$, curve 5 $0.82 \mu\text{F} \leq C \leq 1.2 \mu\text{F}$, curve 6 $1.5 \mu\text{F} \leq C \leq 4.7 \mu\text{F}$, curve 16</p> | <p>1000 V: $0.018 \mu\text{F} \leq C \leq 0.047 \mu\text{F}$, curve 1 $0.056 \mu\text{F} \leq C \leq 0.082 \mu\text{F}$, curve 3 $0.1 \mu\text{F} \leq C \leq 0.27 \mu\text{F}$, curve 4 $0.33 \mu\text{F} \leq C \leq 0.82 \mu\text{F}$, curve 5 $1.0 \mu\text{F} \leq C \leq 3.3 \mu\text{F}$, curve 17</p> |
| <p>1250 V: $0.0082 \mu\text{F} \leq C \leq 0.039 \mu\text{F}$, curve 1 $0.047 \mu\text{F} \leq C \leq 0.082 \mu\text{F}$, curve 3 $0.1 \mu\text{F} \leq C \leq 0.56 \mu\text{F}$, curve 4 $0.82 \mu\text{F} \leq C \leq 2.7 \mu\text{F}$, curve 18</p> | <p>1600 V: $0.0039 \mu\text{F} \leq C \leq 0.012 \mu\text{F}$, curve 1 $0.015 \mu\text{F} \leq C \leq 0.22 \mu\text{F}$, curve 2 $0.27 \mu\text{F} \leq C \leq 0.33 \mu\text{F}$, curve 3 $0.47 \mu\text{F} \leq C \leq 1.2 \mu\text{F}$, curve 19</p> | <p>2000 V: $0.001 \mu\text{F} \leq C \leq 0.012 \mu\text{F}$, curve 1 $0.015 \mu\text{F} \leq C \leq 0.18 \mu\text{F}$, curve 2 $0.33 \mu\text{F} \leq C \leq 0.68 \mu\text{F}$, curve 20</p> | <p>2500 V: $0.001 \mu\text{F} \leq C \leq 0.082 \mu\text{F}$, curve 1 $0.1 \mu\text{F} \leq C \leq 0.39 \mu\text{F}$, curve 21</p> |

HEAT CONDUCTIVITY (G) AS A FUNCTION OF ORIGINAL PITCH AND CAPACITOR BODY THICKNESS IN mW/°C

| W _{max.} (mm) | HEAT CONDUCTIVITY (mW/°C) | | | | |
|---------------------------|---------------------------|---------------|---------------|---------------|---------------|
| | PITCH 15 mm | PITCH 22.5 mm | PITCH 27.5 mm | PITCH 37.5 mm | PITCH 52.5 mm |
| 3.0 | - | - | - | - | - |
| 3.5 | - | - | - | - | - |
| 4.0 | - | - | - | - | - |
| 4.5 | - | - | - | - | - |
| 5.0 | - | - | - | - | - |
| 6.0 | - | - | - | - | - |
| 7.0 | 14 | 17 | - | - | - |
| 8.5 | 16 | 20 | - | - | - |
| 9.0 | 19 | - | 21 | - | - |
| 10.0 | 21 | 23 | - | - | - |
| 11.0 | 22 | - | - | - | - |
| 12.0 | - | - | 24 | - | - |
| 13.0 | - | 28 | - | - | - |
| 15.0 | - | 29 | - | - | - |
| 15.7 | - | - | - | 46 | - |
| 18.0 | - | - | 28 | 54 | - |
| 18.5 | - | - | 32 | 60 | - |
| 21.0 | - | - | 39 | - | - |
| 21.5 | - | - | - | 68 | - |
| 24.0 | - | - | 45 | 78 | - |
| 25.0 | - | - | - | - | - |
| 30.0 | - | - | - | 90 | - |
| 35.0 | - | - | - | - | 133 |

POWER DISSIPATION AND MAXIMUM COMPONENT TEMPERATURE RISE

The power dissipation must be limited in order not to exceed the maximum allowed component temperature rise as a function of the free air ambient temperature.

The power dissipation can be calculated according type detail specification www.vishay.com/doc?28147

The component temperature rise (ΔT) can be measured (see section "Measuring the component temperature" for more details) or calculated by $\Delta T = P/G$:

- ΔT = component temperature rise (°C)
- P = power dissipation of the component (mW)
- G = heat conductivity of the component (mW/°C)

MEASURING THE COMPONENT TEMPERATURE

A thermocouple must be attached to the capacitor body as in:

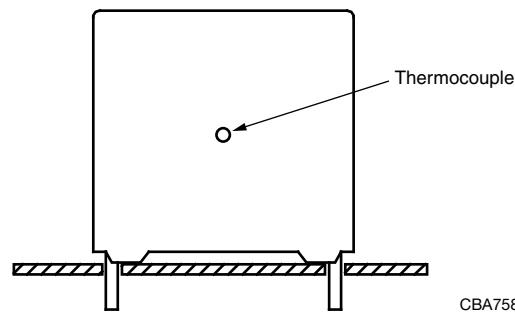

The temperature is measured in unloaded (T_{amb}) and maximum loaded condition (T_C).

The temperature rise is given by $\Delta T = T_C - T_{amb}$.

To avoid radiation or convection, the capacitor should be tested in a wind-free box.

APPLICATION NOTES

For capacitors connected in parallel, normally the proof voltage and possibly the rated voltage must be reduced. For information depending of the capacitance value and the number of parallel connections contact: dc-film@vishay.com

These capacitors are not suitable for mains applications as across-the-line capacitors without additional protection, as described hereunder. These mains applications are strictly regulated in safety standards and therefore electromagnetic interference suppression capacitors conforming the standards must be used.

To select the capacitor for a certain application, the following conditions must be checked:

1. The peak voltage (U_p) shall not be greater than the rated DC voltage (U_{RDC})
2. The peak-to-peak voltage (U_{p-p}) shall not be greater than the maximum (U_{p-p}) to avoid the ionization inception level
3. The voltage peak slope (dU/dt) shall not exceed the rated voltage pulse slope in an RC-circuit at rated voltage and without ringing. If the pulse voltage is lower than the rated DC voltage, the rated voltage pulse slope may be multiplied by U_{RDC} and divided by the applied voltage.

For all other pulses following equation must be fulfilled:

$$2 \times \int_0^T \left(\frac{dU}{dt} \right)^2 \times dt < U_{RDC} \times \left(\frac{dU}{dt} \right)_{\text{rated}}$$

T is the pulse duration

4. The maximum component surface temperature rise must be lower than the limits (see graph "Max. allowed component temperature rise")
5. Since in circuits used at voltages over 280 V peak-to-peak the risk for an intrinsically active flammability after a capacitor breakdown (short circuit) increases, it is recommended that the power to the component is limited to 100 times the values mentioned in the table: "Heat Conductivity"
6. When using these capacitors as across-the-line capacitor in the input filter for mains applications or as series connected with an impedance to the mains the applicant must guarantee that the following conditions are fulfilled in any case (spikes and surge voltages from the mains included)

Note

- See table "Voltage Ratings and Temperature"

7. For capacitors with multiple pins in some cases it is allowed to feed current through the pins additionally to the capacitor to improve filtering properties

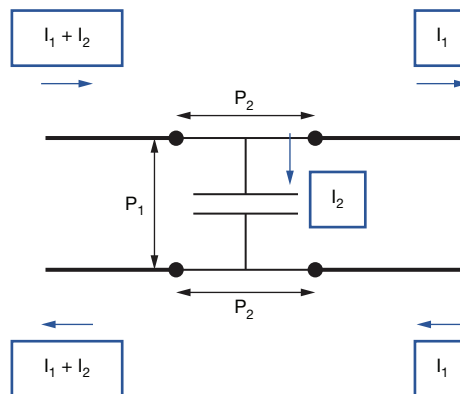

P_1 and P_2 are the pin distance dimensions as mentioned in the mechanical dimensions.

In this case the pins carry the currents I_1 (= the fed through current) and I_2 (= the capacitor current). Due to the additional heating up this fed through current must be limited to 10 % of the maximum allowed capacitor current I_2 . For other currents contact dc-film@vishay.com.



INSPECTION REQUIREMENTS

General Notes

Sub-clause numbers of tests and performance requirements refer to the “Sectional Specification, Specific Reference Data”.

| IEC 60384-17 - FIXED METALLIZED POLYPROPYLENE FILM DIELECTRIC AC AND PULSE CAPACITORS | | |
|--|---|--|
| SUB-CLAUSE NUMBER AND TEST | CONDITIONS | PERFORMANCE REQUIREMENTS |
| SUB-GROUP C1A PART OF SAMPLE OF SUB-GROUP C1 | | |
| 4.1 Dimensions (detail) | | As specified in Chapters “General data” of this specification |
| 4.3.1 Initial measurements | Capacitance Tangent of loss angle: $C \leq 1 \mu\text{F}$ at 100 kHz $1 \mu\text{F} < C \leq 10 \mu\text{F}$ at 10 kHz | |
| 4.3 Robustness of terminations | Tensile: load 10 N; 10 s Bending: load 5 N; 4 x 90° | No visible damage |
| 4.4 Resistance to soldering heat | Method: 1 A Solder bath: 280 °C ± 5 °C Duration: 10 s | |
| 4.14 Component solvent resistance | Isopropylalcohol at room temperature Method: 2 Immersion time: 5 min ± 0.5 min Recovery time: min. 1 h, max. 2 h | |
| 4.4.2 Final measurements | Visual examination Capacitance Tangent of loss angle | No visible damage Legible marking $I\Delta C/CI \leq 1\%$ of the value measured initially. Increase of tan δ : ≤ 0.0005 for: $C \leq 100 \text{ nF}$ at 100 kHz ≤ 0.0010 for: $100 \text{ nF} < C \leq 470 \text{ nF}$ at 100 kHz ≤ 0.0015 for: $470 \text{ nF} < C \leq 1 \mu\text{F}$ at 100 kHz ≤ 0.0015 for: $1 \mu\text{F} < C \leq 10 \mu\text{F}$ at 10 kHz Compared to values measured in 4.3.1 |
| SUB-GROUP C1B OTHER PART OF SAMPLE OF SUB-GROUP C1 | | |
| 4.6.1 Initial measurements | Capacitance Tangent of loss angle: $C \leq 1 \mu\text{F}$ at 100 kHz $1 \mu\text{F} < C \leq 10 \mu\text{F}$ at 10 kHz | |
| 4.15 Solvent resistance of the marking | Isopropylalcohol at room temperature Method: 1 Rubbing material: cotton wool Immersion time: 5 min ± 0.5 min | No visible damage Legible marking |
| 4.6 Rapid change of temperature | $\theta A = -40 \text{ °C}$ $\theta B = +105 \text{ °C}$ 5 cycles Duration $t = 30 \text{ min}$ Visual examination | No visible damage |



| IEC 60384-17 - FIXED METALLIZED POLYPROPYLENE FILM DIELECTRIC AC AND PULSE CAPACITORS | | |
|--|---|---|
| SUB-CLAUSE NUMBER AND TEST | CONDITIONS | PERFORMANCE REQUIREMENTS |
| SUB-GROUP C1B OTHER PART OF SAMPLE OF SUB-GROUP C1 | | |
| 4.7. Vibration | Mounting: see section "Mounting" for more information Procedure B4 Frequency range: 10 Hz to 55 Hz. Amplitude: 0.75 mm or acceleration 98 m/s ² (whichever is less severe) Total duration 6 h. | |
| 4.7.2 Final inspection | Visual examination Mounting: see section "Mounting" for more information | No visible damage |
| 4.9 Shock | Pulse shape: half sine Acceleration: 490 m/s ² Duration of pulse: 11 ms | |
| 4.9.3 Final measurements | Visual examination Capacitance Tangent of loss angle Insulation resistance | No visible damage $\Delta C/C \leq 2\%$ of the value measured in 4.6.1. Increase of $\tan \delta$: ≤ 0.0005 ≤ 0.0010 for: $C \leq 100$ nF at 100 kHz ≤ 0.0010 for: 100 nF < $C \leq 470$ nF at 100 kHz ≤ 0.0015 for: 470 nF < $C \leq 1$ μ F at 100 kHz ≤ 0.0015 for: 1 μ F < $C \leq 10$ μ F at 10 kHz Compared to values measured in 4.6.1 As specified in section "Insulation Resistance" of this specification. |
| SUB-GROUP C1 COMBINED SAMPLE OF SPECIMENS OF SUB-GROUPS C1A AND C1B | | |
| 4.10 Climatic sequence | | |
| 4.10.2 Dry heat | Temperature +105 °C Duration: 16 h | |
| 4.10.3 Damp heat cyclic Test Db, first cycle | | |
| 4.10.4 Cold | Temperature: -40 °C Duration: 2 h | |
| 4.10.6 Damp heat cyclic Test Db remaining cycles | | |
| 4.10.6.2 Final measurements | Voltage proof = U_{RDC} for 1 min within 15 min after removal from test chamber Visual examination Capacitance Tangent of loss angle Insulation resistance | No breakdown or flashover No visible damage Legible marking $\Delta C/C \leq 2\%$ of the value measured in 4.4.2 or 4.9.3 Increase of $\tan \delta$: ≤ 0.0005 for: $C \leq 100$ nF at 100 kHz ≤ 0.0010 for: 100 nF < $C \leq 470$ nF at 100 kHz ≤ 0.0015 for: 470 nF < $C \leq 1$ μ F at 100 kHz ≤ 0.0015 for: 1 μ F < $C \leq 10$ μ F at 10 kHz Compared to values measured in 4.3.1 or 4.6.1 $\geq 50\%$ of values specified in section "Insulation Resistance" of this specification. |



| IEC 60384-17 - FIXED METALLIZED POLYPROPYLENE FILM DIELECTRIC AC AND PULSE CAPACITORS | | |
|---|---|---|
| SUB-CLAUSE NUMBER AND TEST | CONDITIONS | PERFORMANCE REQUIREMENTS |
| SUB-GROUP C2 | | |
| 4.11 Damp heat steady state | 56 days; 40 °C; 90 % to 95 % RH no load | |
| 4.11.1 Initial measurements | Capacitance Tangent of loss angle at 1 kHz | |
| 4.11.3 Final measurements | Voltage proof = U_{RDC} for 1 min within 15 min after removal from test chamber | No breakdown or flashover |
| | Visual examination | No visible damage Legible marking |
| | Capacitance | $ \Delta C/C \leq 2\%$ of the value measured in 4.11.1. |
| | Tangent of loss angle | Increase of $\tan \delta \leq 0.0025$ at 1 kHz Compared to values measured in 4.11.1. |
| | Insulation resistance | $\geq 50\%$ of values specified in section “Insulation resistance” of this specification |
| SUB-GROUP C2A | | |
| 4.12A Damp heat steady state with load | 60 °C; 93 % RH load: U_{RDC} duration: 56 days | |
| 4.12.1A Initial measurements | Capacitance Tangent of loss angle at for $C \leq 1 \mu F$ at 10 kHz for $C > 1 \mu F$ at 1 kHz | |
| 4.12.3A Final measurements | Visual examination | No visible damage Legible marking |
| | Capacitance | $ \Delta C/C \leq 10\%$ of the value measured in 4.12.1. |
| | Tangent of loss angle | Increase of $\tan \delta$: ≤ 0.0240 for $C \leq 1 \mu F$ or ≤ 0.0150 for $C > 1 \mu F$ Compared to values measured in 4.12.1. |
| | Voltage proof U_{RDC} ; 1 min between terminations | No permanent breakdown or flashover |
| | Insulation resistance | $\geq 50\%$ of values specified in section “Insulation resistance” of this specification |



| IEC 60384-17 - FIXED METALLIZED POLYPROPYLENE FILM DIELECTRIC AC AND PULSE CAPACITORS | | |
|---|---|--|
| SUB-CLAUSE NUMBER AND TEST | CONDITIONS | PERFORMANCE REQUIREMENTS |
| SUB-GROUP C3A | | |
| 4.12.1 Endurance | Duration: 2000 h Temperature: 85 °C Voltage: 1.25 x U _{RAC} V _{RMS} , 50 Hz AND Duration: 2000 h Temperature: 105 °C Voltage: 0.875 x U _{RAC} V _{RMS} , 50 Hz | |
| 4.12.1.1 Initial measurements | Capacitance Tangent of loss angle C ≤ 1 µF at 100 kHz 1 µF < C ≤ 10 µF at 10 kHz | |
| 4.12.1.3 Final measurements | Visual examination Capacitance Tangent of loss angle Insulation resistance | No visible damage Legible marking ΔC/Ci ≤ 5 % for C > 10 nF ΔC/Ci ≤ 8 % for C ≤ 10 nF Compared to values measured in 4.12.1.1 Increase of tan δ: ≤ 0.0005 for: C ≤ 100 nF at 100 kHz ≤ 0.0010 for: 100 nF < C ≤ 470 nF at 100 kHz ≤ 0.0015 for: 470 nF < C ≤ 1 µF at 100 kHz ≤ 0.0015 for: 1 µF < C ≤ 10 µF at 10 kHz Compared to values measured in 4.12.1.1 ≥ 50 % of values specified in section “Insulation resistance” of this specification. |
| SUB-GROUP C3B | | |
| 4.12.2 Endurance test at 50 Hz alternating voltage | 0.625 x U _{RAC} at 125 °C 500 h | |
| 4.12.2.1 Initial measurements | Capacitance Tangent of loss angle: C ≤ 1 µF at 100 kHz 1 µF < C ≤ 10 µF at 10 kHz | |
| 4.12.2.3 Final measurements | Visual examination Capacitance Tangent of loss angle Insulation resistance | No visible damage Legible marking ΔC/Ci ≤ 10 % + 100 pF compared to values measured in 4.12.2.1 Increase of tan δ: ≤ 0.0005 for: C ≤ 100 nF at 100 kHz ≤ 0.0010 for: 100 nF < C ≤ 470 nF at 100 kHz ≤ 0.0015 for: 470 nF < C ≤ 1 µF at 100 kHz ≤ 0.0015 for: 1 µF < C ≤ 10 µF at 10 kHz Compared to values measured in 4.12.2.1 ≥ 50 % of values specified in section “Insulation Resistance” of this specification. |



| IEC 60384-17 - FIXED METALLIZED POLYPROPYLENE FILM DIELECTRIC AC AND PULSE CAPACITORS | | |
|--|---|--|
| SUB-CLAUSE NUMBER AND TEST | CONDITIONS | PERFORMANCE REQUIREMENTS |
| SUB-GROUP C4 | | |
| 4.2.6 Temperature characteristics Initial measurements Intermediate measurements | Capacitance Capacitance at -40 °C Capacitance at 20 °C Capacitance at +125 °C | For -40 °C to +20 °C: +1 % ≤ ΔC/CI ≤ 3.75 % or for 20 °C to 125 °C: -7.5 % ≤ ΔC/CI ≤ 0 % Compared to values measured in 4.12.1.1 |
| Final measurements | Capacitance | As specified in section “Capacitance” of this specification |
| | Insulation resistance | As specified in section “Insulation Resistance” of this specification |
| 4.13 Charge and discharge | 10 000 cycles Charged to U _{RDC} Discharge resistance: $R = \frac{U_{RDC}}{2.5 \times C (dU/dt)}$ | |
| 4.13.1 Initial measurements | Capacitance Tangent of loss angle: C ≤ 1 μF at 100 kHz 1 μF < C ≤ 10 μF at 10 kHz C > 10 μF at 1 kHz | |
| 4.13.3 Final measurements | Capacitance | ΔC/CI ≤ 1 % compared to values measured in 4.13.1. |
| | Tangent of loss angle | Increase of tan δ: ≤ 0.0005 for: C ≤ 100 nF at 100 kHz ≤ 0.0010 for: 100 nF < C ≤ 470 nF at 100 kHz ≤ 0.0015 for: 470 nF < C ≤ 1 μF at 100 kHz ≤ 0.0015 for: 1 μF < C ≤ 10 μF at 10 kHz Compared to values measured in 4.13.1 |
| | Insulation resistance | ≥ 50 % of values specified in section “Insulation Resistance” of this specification. |



| AUTOMOTIVE AEC-Q200, REVISION D QUALIFICATION | | | | |
|---|----------|---|-------------|---|
| STRESS | REVISION | CONDITION | SAMPLE SIZE | PERFORMANCE REQUIREMENTS |
| 1. High temperature exposure (storage) | D | Test as per MIL-STD 202, method 108 Temp.: 105 °C; unpowered Duration: 1000 h | 77 | $ \Delta C/C \leq 5\%$ ≤ 0.0005 for $C \leq 100$ nF at 100 kHz ≤ 0.0010 for 100 nF $< C \leq 470$ nF at 100 kHz ≤ 0.0015 for 470 nF $< C \leq 1$ μ F at 100 kHz ≤ 0.0015 for 1 μ F $< C \leq 10$ μ F at 10 kHz IR $> 50\%$ of initial specified value |
| 2. Temperature cycling | D | Test as per JESD22, method JA-104 Total no. of cycles: 1000 cycles Lower temp.: -40 °C Upper temp.: +105 °C Dwell each 30 min as per rev. D | 77 | $ \Delta C/C \leq 5\%$ Increase of tan δ : ≤ 0.0005 for $C \leq 100$ nF at 100 kHz ≤ 0.0010 for 100 nF $< C \leq 470$ nF at 100 kHz ≤ 0.0015 for 470 nF $< C \leq 1$ μ F at 100 kHz ≤ 0.0015 for 1 μ F $< C \leq 10$ μ F at 10 kHz IR $> 50\%$ of initial specified value |
| 3. Moisture resistance | D | Test as per MIL-STD 202, method 106 10 cycles at 24 h/cycle unpowered | 77 | $ \Delta C/C \leq 5\%$ Increase of tan δ : ≤ 0.0005 for $C \leq 100$ nF at 100 kHz ≤ 0.0010 for 100 nF $< C \leq 470$ nF at 100 kHz ≤ 0.0015 for 470 nF $< C \leq 1$ μ F at 100 kHz ≤ 0.0015 for 1 μ F $< C \leq 10$ μ F at 10 kHz IR $> 50\%$ of initial specified value |
| 4. Biased humidity AC | D | Test as per MIL-STD 202, method 103 Temp.: 40 °C; RH: 93 %; U_{RAC} Duration: 1000 h | 77 | $ \Delta C/C \leq 5\%$ Increase of tan δ : ≤ 0.008 at 1 kHz IR $> 50\%$ of initial specified value |
| 5. Biased humidity DC | D | Test as per MIL-STD 202, method 103 Temp.: 40 °C; RH: 93 %; U_{RDC} Duration: 1000 h | 77 | $ \Delta C/C \leq 5\%$ Increase of tan δ : ≤ 0.008 at 1 kHz IR $> 50\%$ of initial specified value |
| 6. Operational life AC | D | Test as per MIL-STD 202, method 108 Temp. = 105 °C; load = U_{RAC} Duration: 1000 h | 77 | $ \Delta C/C \leq 5\%$ Increase of tan δ : ≤ 0.0005 for $C \leq 100$ nF at 100 kHz ≤ 0.0010 for 100 nF $< C \leq 470$ nF at 100 kHz ≤ 0.0015 for 470 nF $< C \leq 1$ μ F at 100 kHz ≤ 0.0015 for 1 μ F $< C \leq 10$ μ F at 10 kHz IR $> 50\%$ of initial specified value |
| 7. Operational life DC | D | Test as per MIL-STD 202, method 108 Temp. = 105 °C; Load = U_{RDC} Duration: 1000 h | 77 | $ \Delta C/C \leq 5\%$ Increase of tan δ : ≤ 0.0005 for $C \leq 100$ nF at 100 kHz ≤ 0.0010 for 100 nF $< C \leq 470$ nF at 100 kHz ≤ 0.0015 for 470 nF $< C \leq 1$ μ F at 100 kHz ≤ 0.0015 for 1 μ F $< C \leq 10$ μ F at 10 kHz IR $> 50\%$ of initial specified value |
| 8. Terminal strength (lead) | D | Test as per MIL-STD 202, method 211 Test leaded device lead integrity only. - A (pull-test): 2.27 kg (10 s) - C (wire-lead bend test): 227 g (3 x 3 s) | 30 | No visual damage |
| 9. Resistance to solvents | D | MIL-STD-202 method 215 - Also aqueous chemical - OKEM clean or equivalent. Do not use banned solvents. | 5 | No visual damage Legible marking |
| 10. Mechanical shock | D | MIL-STD-202 method 213 100 g's; 6 ms; half sine; 3.75 m/s | 30 | No visual damage |
| 11. Vibration | D | MIL-STD-202 method 204 5 g's for 20 min 12 cycles x 3 directions 10 Hz to 2000 Hz | 30 | No visual damage |
| 12. Resistance to soldering heat | D | MIL-STD-202 method 210 Temp.: 280 °C; time: 10 s solder within 1.5 mm of device body | 30 | $ \Delta C/C \leq 5\%$ Increase of tan δ : ≤ 0.0005 for $C \leq 100$ nF at 100 kHz ≤ 0.0010 for 100 nF $< C \leq 470$ nF at 100 kHz ≤ 0.0015 for 470 nF $< C \leq 1$ μ F at 100 kHz ≤ 0.0015 for 1 μ F $< C \leq 10$ μ F at 10 kHz IR $> 50\%$ of initial specified value |
| 13. Solderability | D | J-STD-002 Leaded: method A at 235 °C, category 3 (245 °C / 3 s) | 15 | Good tinning as evidence by free flowing of the solder with wetting of terminations $> 95\%$ |
| 14. Flammability | D | UL-94 One flame application Class B | 15 | V-0 is acceptable. Class B or C according IEC is also acceptable |