

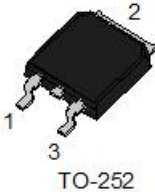
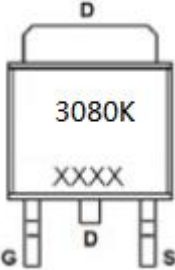
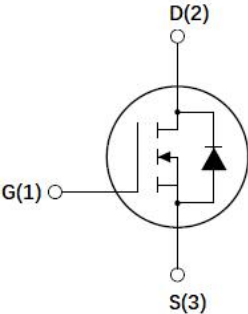

## Description

<p><b>Features</b></p> <ul style="list-style-type: none"> <li>• 30V,80A</li> <li>• <math>R_{DS(ON)}=3.8m\Omega</math> (Typ.) @ <math>V_{GS}=10V</math></li> <li>• <math>R_{DS(ON)}=6.5m\Omega</math> (Typ.) @ <math>V_{GS}=4.5V</math></li> <li>• Advanced Trench Technology</li> <li>• Provide Excellent <math>R_{DS(ON)}</math> and Low Gate Charge</li> </ul>	<p><b>Application</b></p> <ul style="list-style-type: none"> <li>• Load Switch</li> <li>• PWM Application</li> </ul>
<p><b>Package</b></p>   	

## Absolute Maximum Ratings ( $T_C=25^\circ C$ unless otherwise specified)

Symbol	Parameter	Max.	Units
$V_{DSS}$	Drain-Source Voltage	30	V
$V_{GSS}$	Gate-Source Voltage	$\pm 20$	V
$I_D$	Continuous Drain Current	$T_C = 25^\circ C$	80
		$T_C = 100^\circ C$	62
$I_{DM}$	Pulsed Drain Current <sup>note1</sup>	300	A
$E_{AS}$	Single Pulsed Avalanche Energy <sup>note2</sup>	210	mJ
$P_D$	Power Dissipation	$T_C = 25^\circ C$	81
$R_{\theta JC}$	Thermal Resistance, Junction to Case	1.87	$^\circ C/W$
$T_J, T_{STG}$	Operating and Storage Temperature Range	-55 to +175	$^\circ C$



#### Electrical Characteristics (T<sub>c</sub>=25°C unless otherwise specified)

Symbol	Parameter	Test Condition	Min.	Typ.	Max.	Units
<b>Off Characteristic</b>						
V <sub>(BR)DSS</sub>	Drain-Source Breakdown Voltage	V <sub>GS</sub> =0V, I <sub>D</sub> =250μA	30	-	-	V
I <sub>DSS</sub>	Zero Gate Voltage Drain Current	V <sub>DS</sub> =30V, V <sub>GS</sub> =0V,	-	-	1.0	μA
I <sub>GSS</sub>	Gate to Body Leakage Current	V <sub>DS</sub> =0V, V <sub>GS</sub> =±20V	-	-	±100	nA
<b>On Characteristics</b>						
V <sub>GS(th)</sub>	Gate Threshold Voltage	V <sub>DS</sub> =V <sub>GS</sub> , I <sub>D</sub> =250μA	1.0	1.5	2.5	V
R <sub>DS(on)</sub>	Static Drain-Source on-Resistance <small>note3</small>	V <sub>GS</sub> =10V, I <sub>D</sub> =30A	-	3.8	6.5	mΩ
		V <sub>GS</sub> =4.5V, I <sub>D</sub> =20A	-	6.5	10	
g <sub>FS</sub>	Forward Transconductance	V <sub>DS</sub> =5V, I <sub>D</sub> =15A	-	26	-	S
<b>Dynamic Characteristics</b>						
C <sub>iss</sub>	Input Capacitance	V <sub>DS</sub> =15V, V <sub>GS</sub> =0V, f=1.0MHz	-	2153	-	pF
C <sub>oss</sub>	Output Capacitance		-	327	-	pF
C <sub>rss</sub>	Reverse Transfer Capacitance		-	287	-	pF
Q <sub>g</sub>	Total Gate Charge	V <sub>DS</sub> =25V, I <sub>D</sub> =30A, V <sub>GS</sub> =10V	-	45	-	nC
Q <sub>gs</sub>	Gate-Source Charge		-	3	-	nC
Q <sub>gd</sub>	Gate-Drain("Miller") Charge		-	15	-	nC
<b>Switching Characteristics</b>						
t <sub>d(on)</sub>	Turn-on Delay Time	V <sub>DS</sub> =15V, I <sub>D</sub> =30A, R <sub>GEN</sub> =3Ω, V <sub>GS</sub> =10V	-	21	-	ns
t <sub>r</sub>	Turn-on Rise Time		-	32	-	ns
t <sub>d(off)</sub>	Turn-off Delay Time		-	59	-	ns
t <sub>f</sub>	Turn-off Fall Time		-	34	-	ns
<b>Drain-Source Diode Characteristics and Maximum Ratings</b>						
I <sub>S</sub>	Maximum Continuous Drain to Source Diode Forward Current		-	-	80	A
I <sub>SM</sub>	Maximum Pulsed Drain to Source Diode Forward Current		-	-	300	A
V <sub>SD</sub>	Drain to Source Diode Forward Voltage	V <sub>GS</sub> =0V, I <sub>S</sub> =30A	-	-	1.2	V
t <sub>rr</sub>	Body Diode Reverse Recovery Time	I <sub>F</sub> =20A, dI/dt=100A/μs	-	15	-	ns
Q <sub>rr</sub>	Body Diode Reverse Recovery Charge		-	4	-	nC

Notes: 1. Repetitive Rating: Pulse Width Limited by Maximum Junction Temperature

2. EAS condition: T<sub>J</sub>=25°C, V<sub>DD</sub>=30V, V<sub>G</sub>=10V, R<sub>G</sub>=25Ω, L=0.5mH

3. Pulse Test: Pulse Width≤300μs, Duty Cycle≤0.5%



Typical Performance Characteristics

Figure 1: Output Characteristics

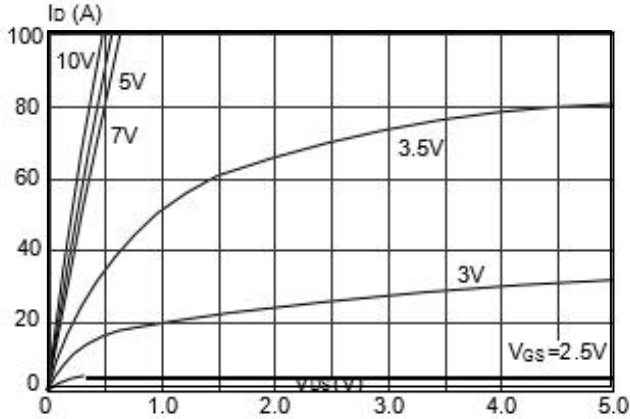

Figure 2: Typical Transfer Characteristics

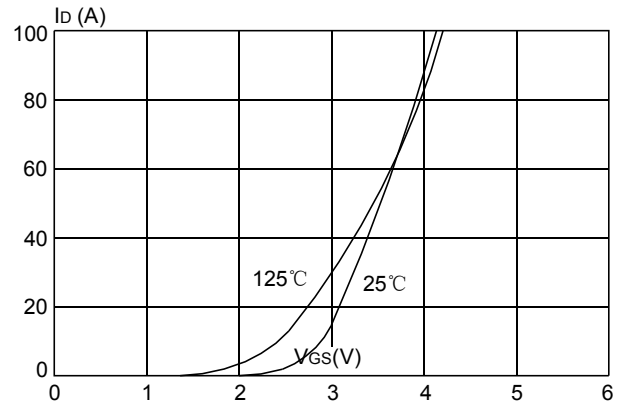

Figure 3: On-resistance vs. Drain Current

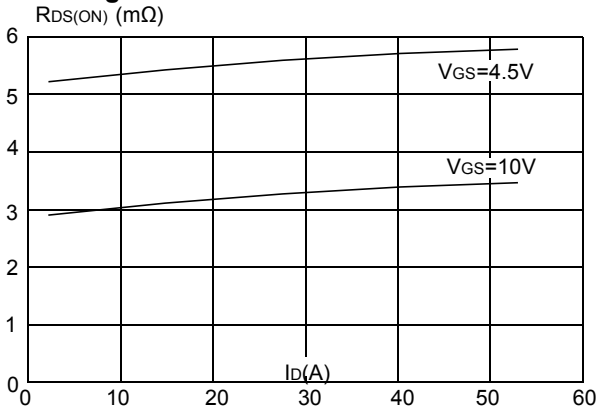

Figure 4: Body Diode Characteristics

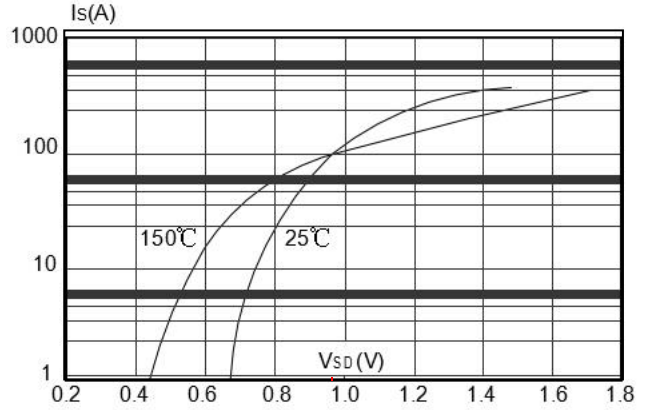

Figure 5: Gate Charge Characteristics

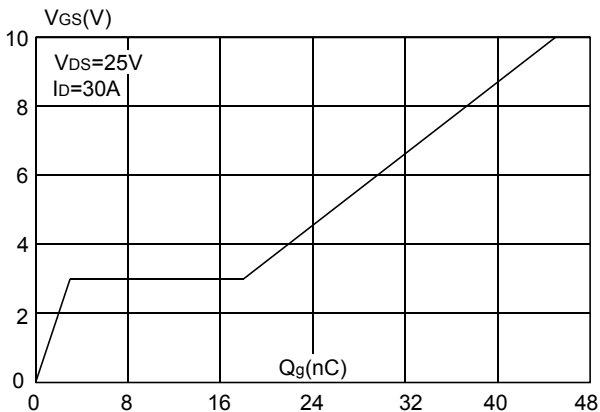
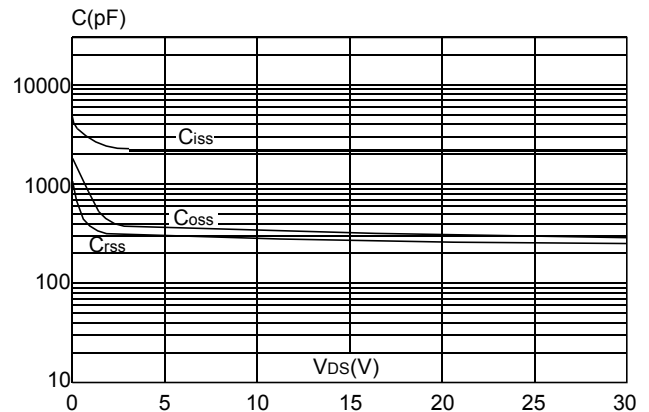
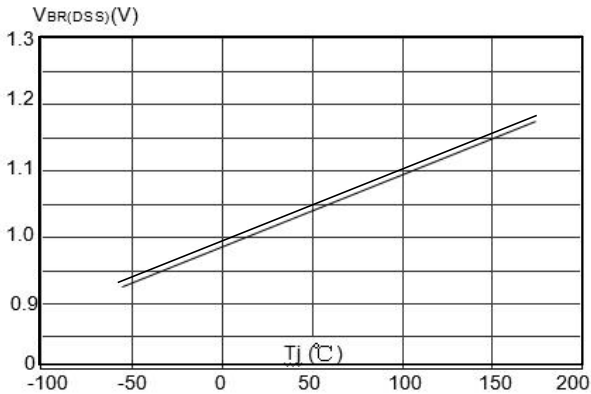

Figure 6: Capacitance Characteristics

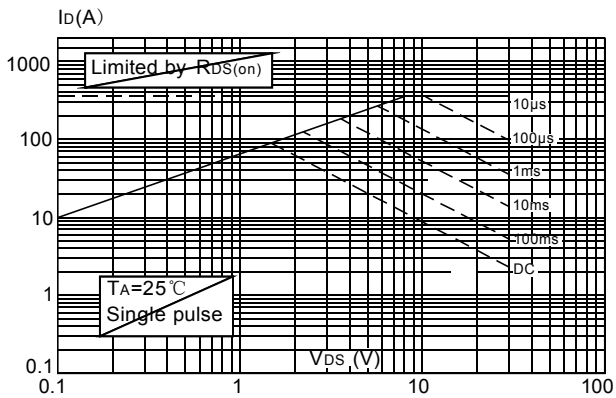



**Figure 7:** Normalized Breakdown Voltage vs. Junction Temperature



**Figure 9:** Maximum Safe Operating Area



**Figure.11:** Maximum Effective Transient Thermal Impedance, Junction-to-Case (TO-252)

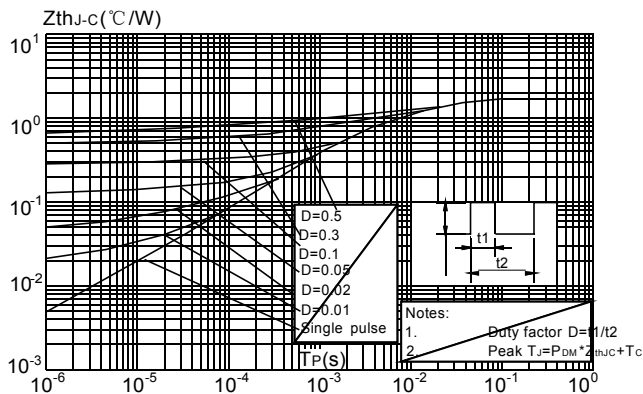

**Figure 8:** Normalized on Resistance vs. Junction Temperature

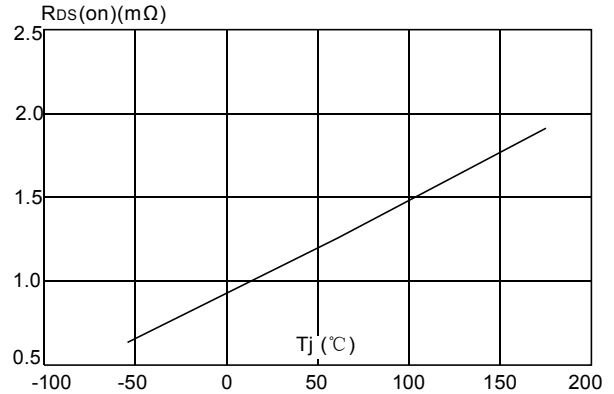

**Figure 10:** Maximum Continuous Drain Current vs. Case Temperature

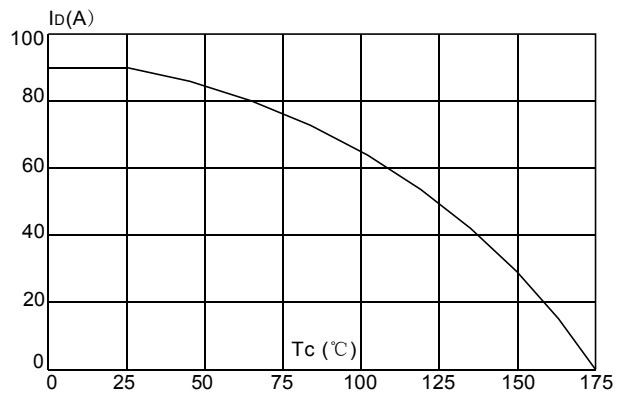

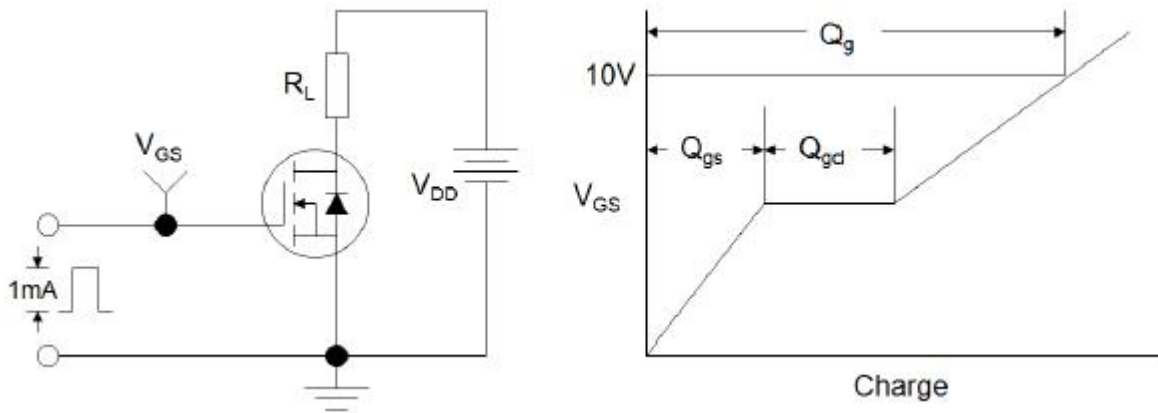

Figure 1: Gate Charge Test Circuit & Waveform

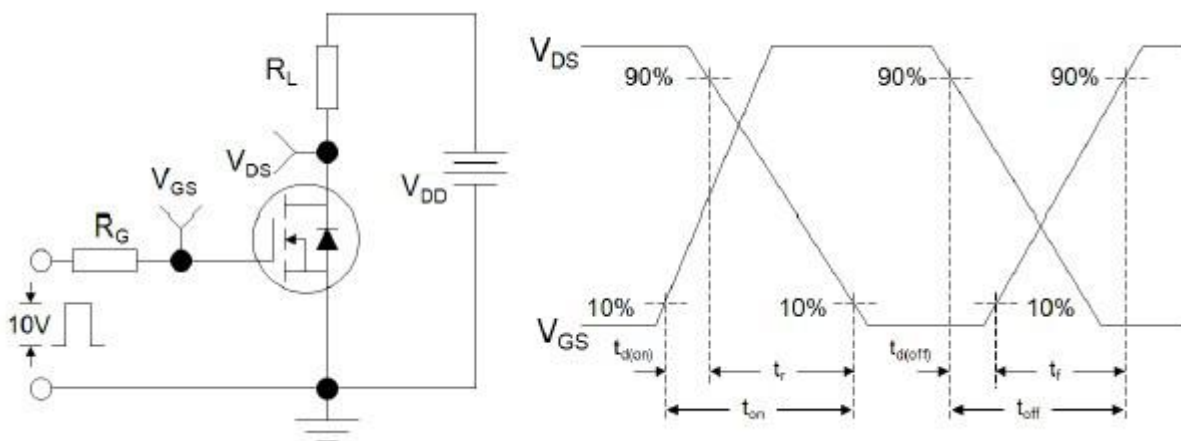

Figure 2: Resistive Switching Test Circuit & Waveforms

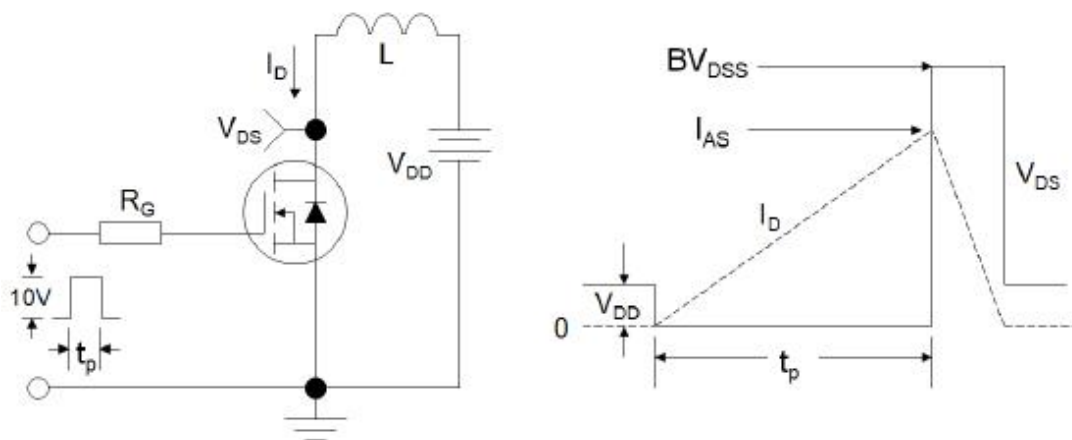
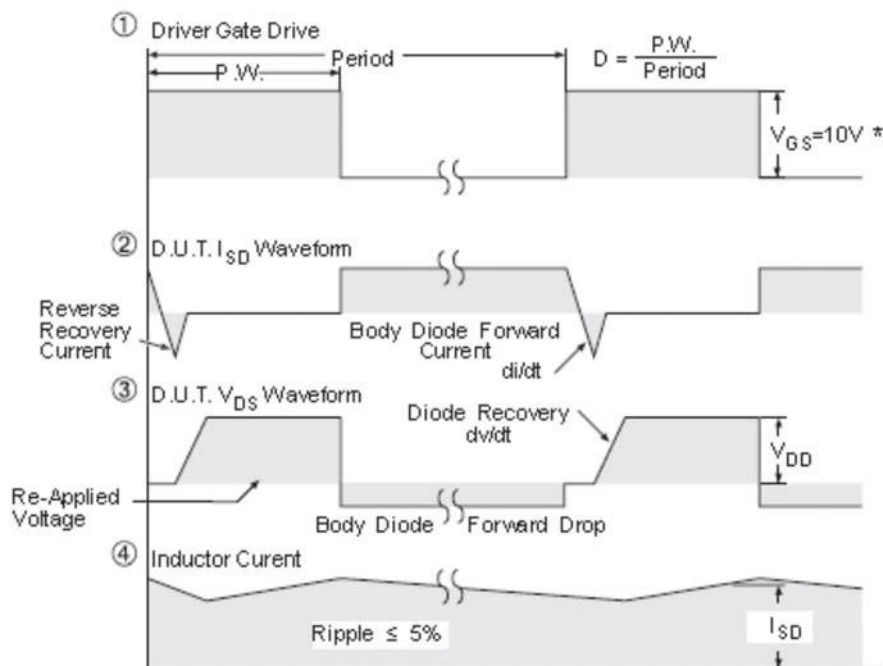
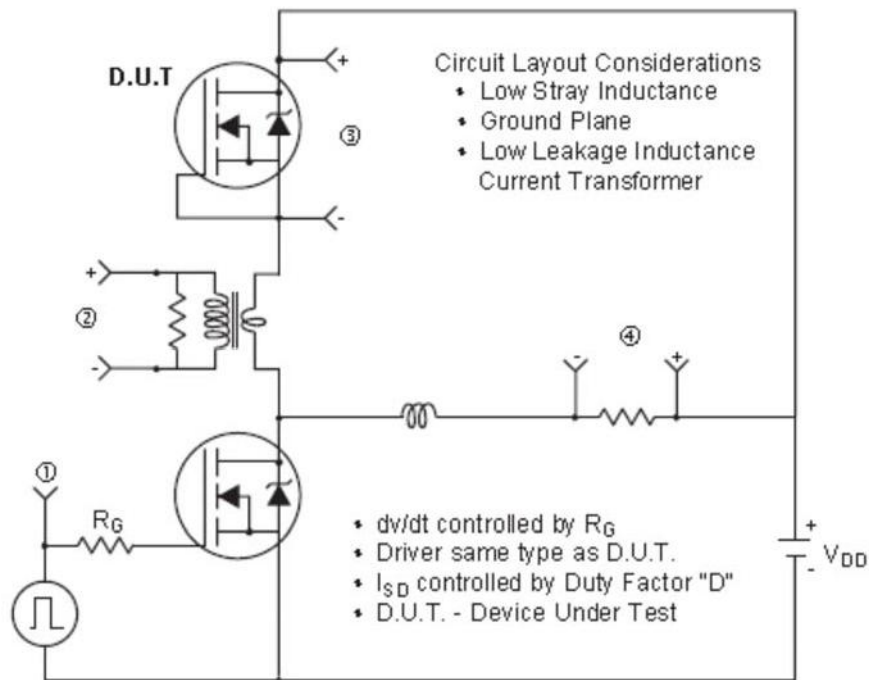

Figure 3: Unclamped Inductive Switching Test Circuit & Waveforms



\*  $V_{GS} = 5V$  for Logic Level Devices

Figure 4: Peak Diode Recovery  $dv/dt$  Test Circuit & Waveforms (For N-channel)



## TO-252 Package Information

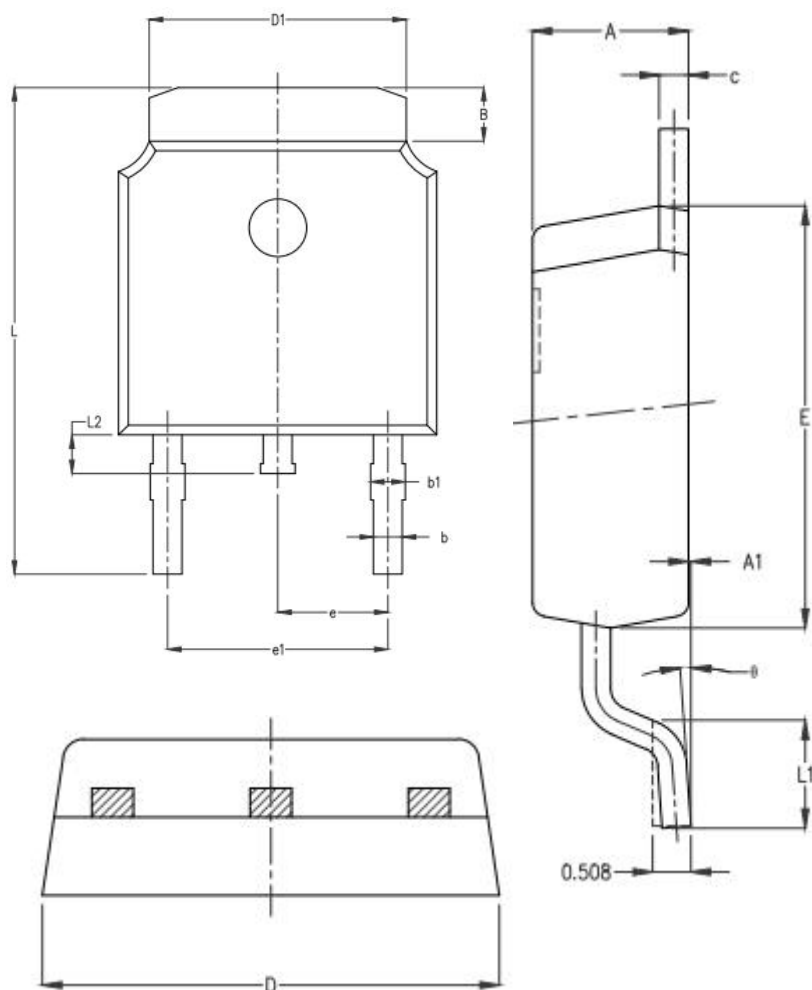

SYMBOL	MILLIMETER		
	MIN	NOM	MAX
A	2.15	2.25	2.35
A1	0.00	0.06	0.12
B	0.96	1.11	1.26
b	0.59	0.69	0.79
b1	0.69	0.81	0.93
c	0.34	0.42	0.50
D	6.45	6.60	6.75
D1	5.23	5.33	5.43
E	5.95	6.10	6.25
e	2.286TYP.		
e1	4.47	4.57	4.67
L	9.90	10.10	10.30
L1	1.40	1.55	1.70
L2	0.60	0.80	1.00
θ	0°	4°	8°