



DESCRIPTION:

With high ability to withstand the shock loading of large current, JCT151K-800R of silicon controlled rectifiers provide high dv/dt rate with strong resistance to electromagnetic interference. They are especially recommended for use on solid state relay, motorcycle, power charger, T-tools etc. Package TO-252-4R is RoHS compliant. (2011/65/EU)

MAIN FEATURES

Symbol	Value	Symbol
V_{DRM}/V_{RRM}	800	V
$I_{T(RMS)}$	12	A
I_{GT}	≤ 15	mA

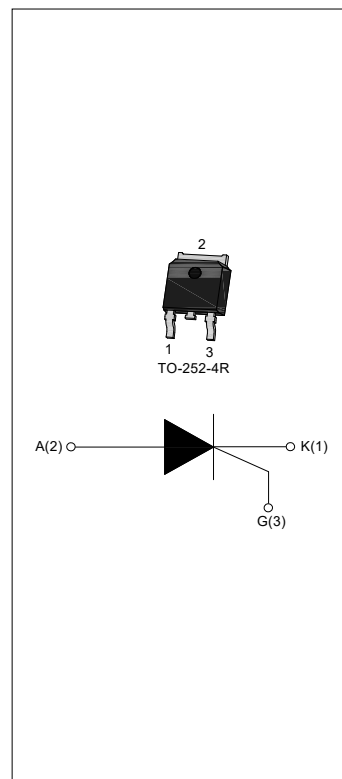

ABSOLUTE MAXIMUM RATINGS

Parameter		Symbol	Value	Unit
Storage junction temperature range		T_{stg}	-40 - 150	$^{\circ}C$
Operating junction temperature range		T_j	-40 - 125	$^{\circ}C$
Repetitive peak off-state voltage ($T_j=25^{\circ}C$)		V_{DRM}	800	V
Repetitive peak reverse voltage ($T_j=25^{\circ}C$)		V_{RRM}	800	V
RMS on-state current	TO-252-4R ($T_c=115^{\circ}C$)	$I_{T(RMS)}$	12	A
Non repetitive surge peak on-state current (F=50Hz tp=10ms)		I_{TSM}	120	A
Non repetitive surge peak on-state current (F=60Hz tp=8.3ms)		I_{TSM}	132	A
I^2t value for fusing (tp=10ms)		I^2t	72	A^2s
Repetitive rate of rise of on-state current ($I_G=2 \times I_{GT}$)		dI/dt	50	$A/\mu s$
Peak gate current		I_{GM}	2	A
Peak gate power		P_{GM}	5	W

Average gate power dissipation	$P_{G(AV)}$	0.5	W
--------------------------------	-------------	-----	---

ELECTRICAL CHARACTERISTICS ($T_j=25^\circ\text{C}$ unless otherwise specified)

Symbol	Test Condition	Value			Unit
		MIN.	TYP.	MAX.	
I_{GT}	$V_D=12\text{V } R_L=33\Omega$	-	4	15	mA
V_{GT}		-	0.75	1.5	V
V_{GD}	$V_D=V_{DRM} T_j=125^\circ\text{C } R_L=3.3\text{K}\Omega$	0.2	-	-	V
I_L	$I_G=1.2I_{GT}$	-	12	40	mA
I_H	$I_T=500\text{mA}$	-	12	30	mA
dv/dt	$V_D=2/3V_{DRM}$ Gate Open $T_j=125^\circ\text{C}$	50	-	-	V/ μs

STATIC CHARACTERISTICS

Symbol	Parameter		Value(MAX)	Unit
V_{TM}	$I_{TM}=23\text{A } t_p=380\mu\text{s}$	$T_j=25^\circ\text{C}$	1.6	V
V_{TO}	Threshold voltage	$T_j=125^\circ\text{C}$	1.0	V
R_d	Dynamic resistance	$T_j=125^\circ\text{C}$	35	m Ω
I_{DRM}	$V_D=V_{DRM} V_R=V_{RRM}$	$T_j=25^\circ\text{C}$	10	μA
I_{RRM}		$T_j=125^\circ\text{C}$	1	mA

THERMAL RESISTANCES

Symbol	Parameter		Value	Unit
$R_{th(j-c)}$	Junction to case	TO-252-4R	1.3	$^\circ\text{C}/\text{W}$
$R_{th(j-a)}$	Junction to ambient	TO-252-4R	70	

ORDERING INFORMATION

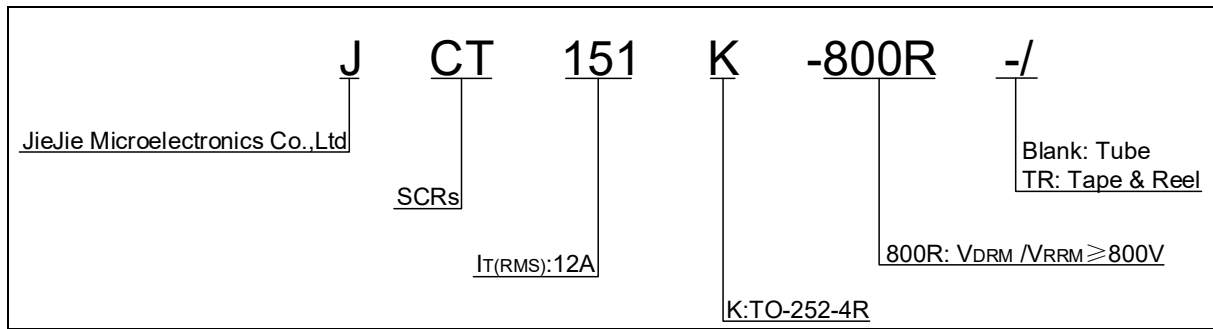

MARKING

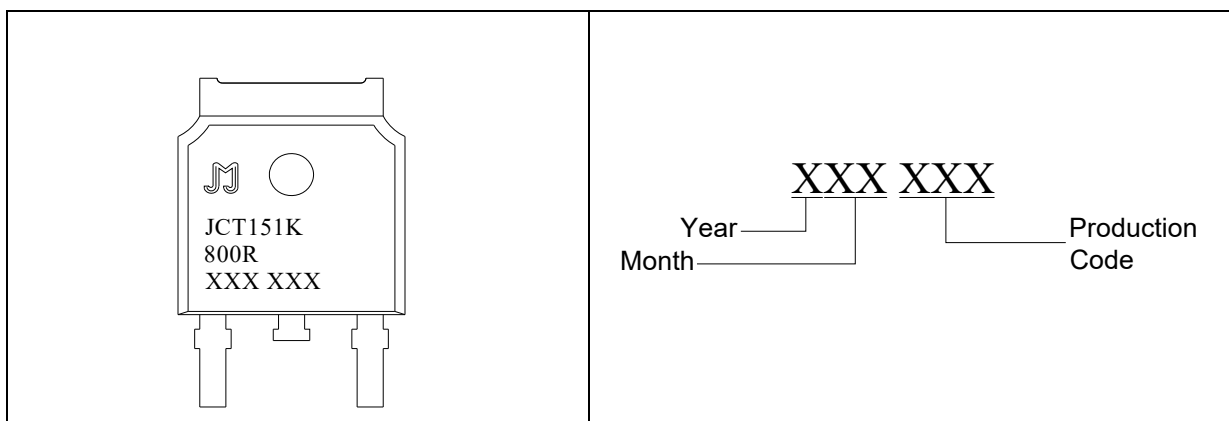

FIG.1: Maximum power dissipation versus RMS on-state current

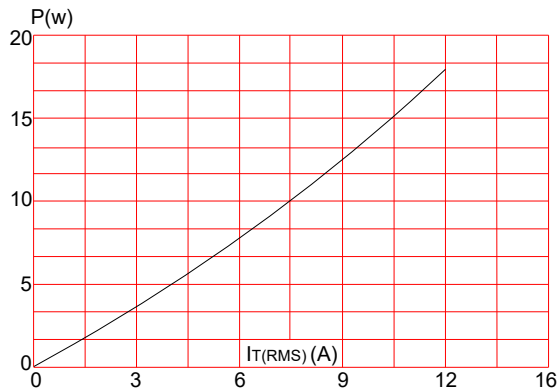

FIG.3: Surge peak on-state current versus number of cycles

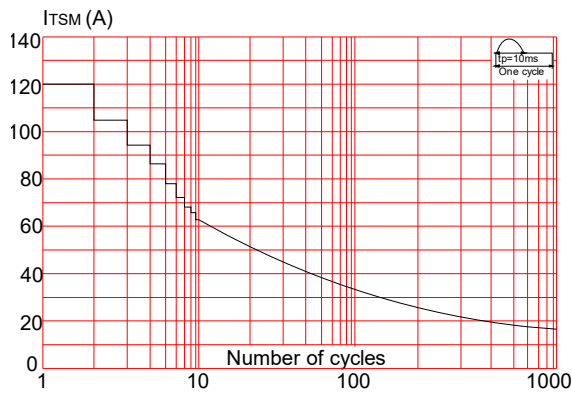

FIG.5: Non-repetitive surge peak on-state current for a sinusoidal pulse with width $t_p < 10\text{ms}$, and corresponding value of $\int i^2 t$ ($di/dt < 50\text{A}/\mu\text{s}$)

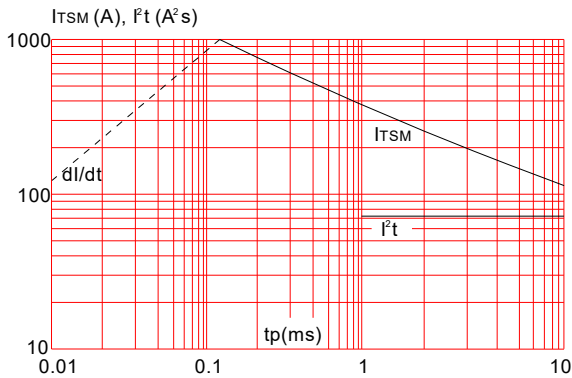

FIG.2: RMS on-state current versus ambient temperature (printed circuit board FR4, copper thickness: $35\mu\text{m}$) (full cycle)

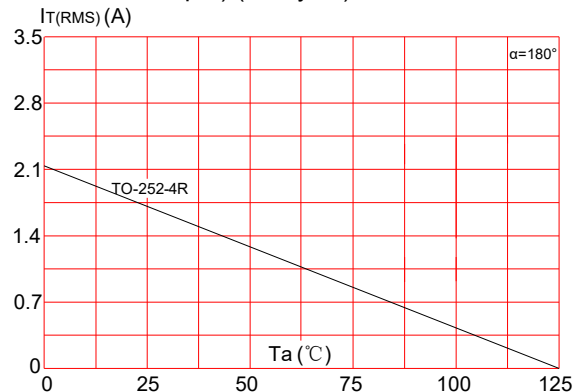

FIG.4: On-state characteristics (maximum values)

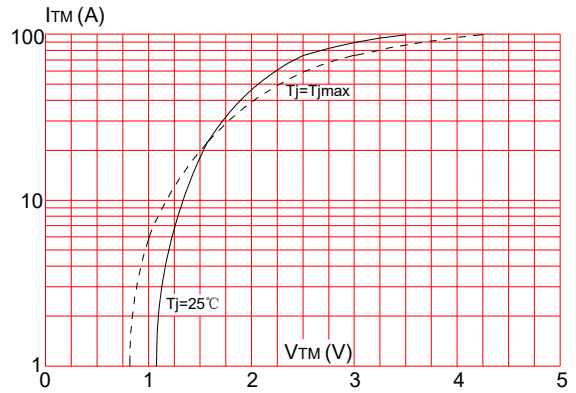
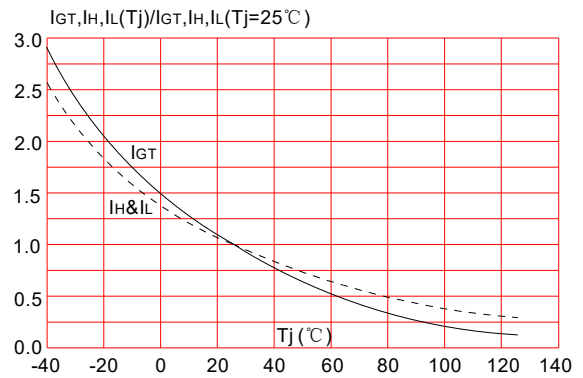
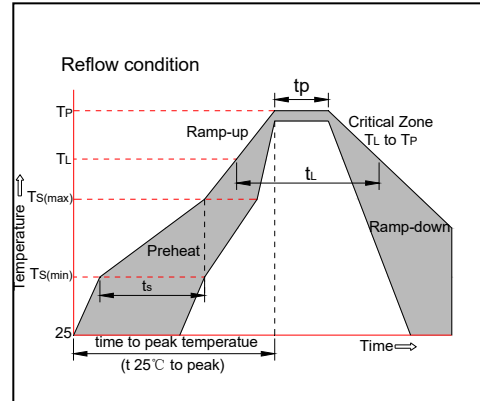

FIG.6: Relative variations of gate trigger current, holding current and latching current versus junction temperature



SOLDERING PARAMETERS

Reflow Condition		Pb-Free assembly (see figure at right)
Pre Heat	-Temperature Min ($T_{s(min)}$)	+150°C
	-Temperature Max($T_{s(max)}$)	+200°C
	-Time (Min to Max) (ts)	60-180 secs.
Average ramp up rate (Liquidus Temp (T_L) to peak)		3°C/sec. Max
$T_{s(max)}$ to T_L - Ramp-up Rate		3°C/sec. Max
Reflow	-Temperature(T_L) (Liquidus)	+217°C
	-Temperature(t_L)	60-150 secs.
Peak Temp (T_P)		+260(+0/-5)°C
Time within 5°C of actual Peak Temp (t_p)		20-40secs.
Ramp-down Rate		6°C/sec. Max
Time 25°C to Peak Temp (T_P)		8 min. Max
Do not exceed		+260°C



ORDERING INFORMATION

Order code	Voltage V_{DRM}/V_{RRM} (V)	IGT(mA)	Package	Base qty. (pcs)	Delivery mode
JCT151K-800R	800	15	TO-252-4R	80	Tube
				2,500	Tape & Reel

Document Revision History

Date	Revision	Changes
Mar 1, 2022	1	Last update

PACKAGE MECHANICAL DATA

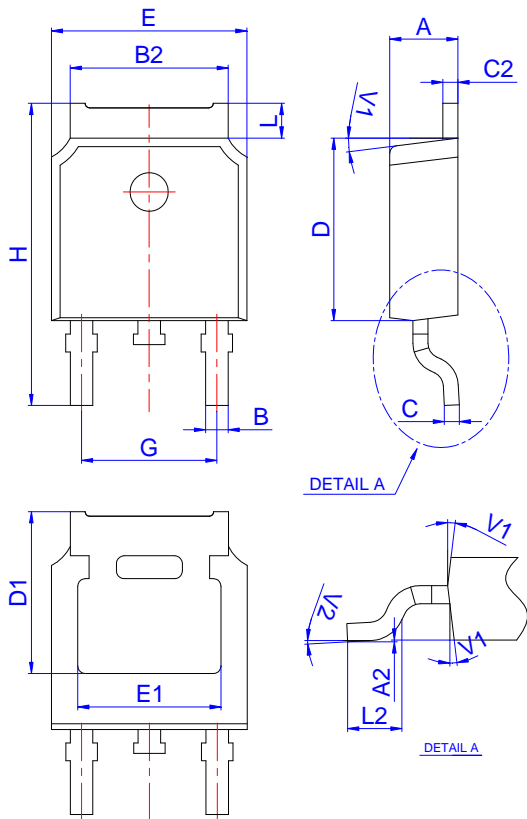

Ref.	Dimensions					
	Millimeters			Inches		
	Min.	Typ.	Max.	Min.	Typ.	Max.
A	2.10		2.50	0.083		0.098
A2	0		0.10	0		0.004
B	0.66		0.86	0.026		0.034
B2	5.18		5.48	0.202		0.216
C	0.40		0.60	0.016		0.024
C2	0.44		0.58	0.017		0.023
D	5.90		6.30	0.232		0.248
D1	5.30REF			0.209REF		
E	6.40		6.80	0.252		0.268
E1	4.63			0.182		
G	4.47		4.67	0.176		0.184
H	9.50		10.70	0.374		0.421
L	1.09		1.21	0.043		0.048
L2	1.35		1.65	0.053		0.065
V1		7°			7°	
V2	0°		6°	0°		6°

FOOTPRINT-TO-252-4R (dimensions in mm)

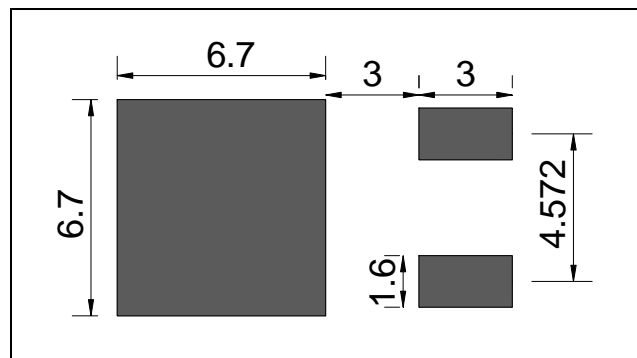

DELIVERY MODE

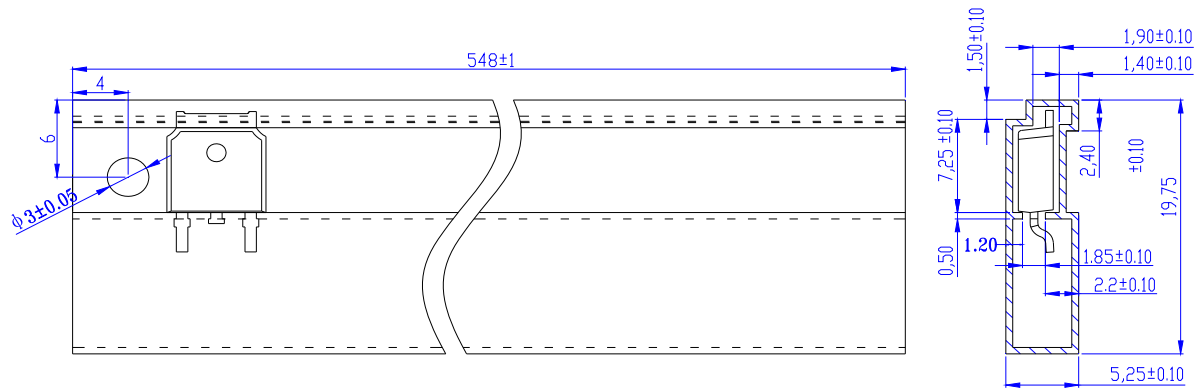

PACKAGE	OUTLINE	TUBE (PCS)	INNER BOX (PCS)	PER CARTON
TO-252-4R	TUBE	80	4,000	20,000

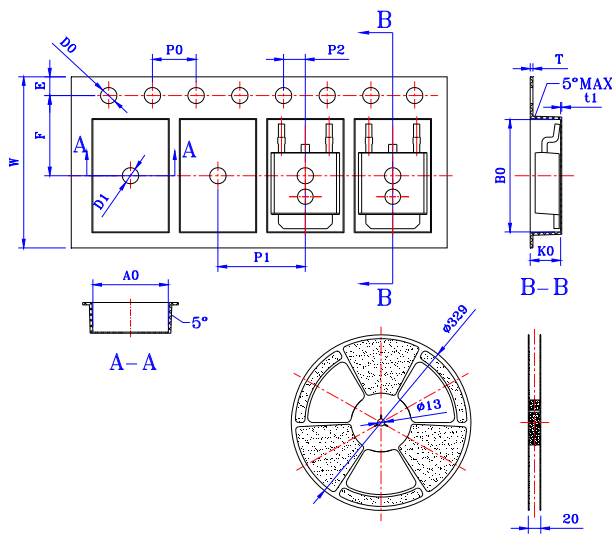

Ref.	Dimensions					
	Millimeters			Inches		
	Min.	Typ.	Max.	Min.	Typ.	Max.
W	15.90	16.00	16.10	0.626	0.630	0.634
E	1.65	1.75	1.85	0.065	0.069	0.073
F	7.40	7.50	7.60	0.291	0.295	0.299
D0	1.40	1.50	1.60	0.055	0.059	0.063
D1	1.40	1.50	1.60	0.055	0.059	0.063
P0	3.90	4.00	4.10	0.154	0.157	0.161
P1	7.90	8.00	8.10	0.311	0.315	0.319
P2	1.90	2.00	2.10	0.075	0.079	0.083
10P0	39.80	40.00	40.20	1.567	1.575	1.583
A0	6.85	6.90	7.00	0.270	0.272	0.276
B0	10.45	10.50	10.60	0.411	0.413	0.417
K0	2.68	2.78	2.88	0.106	0.109	0.113
T	0.24	-	0.27	0.009	-	0.011
t1	0.10	-	-	0.004	-	-

PACKAGE	OUTLINE	REEL (PCS)	PER CARTON (PCS)	TAPE & REEL
TO-252-4R	TAPING	2,500	25,000	13 inch



Information furnished in this document is believed to be accurate and reliable. However, Jiangsu JieJie Microelectronics Co.,Ltd assumes no responsibility for the consequences of use without consideration for such information nor use beyond it. Information mentioned in this document is subject to change without notice, apart from that when an agreement is signed, Jiangsu JieJie complies with the agreement. Products and information provided in this document have no infringement of patents. Jiangsu JieJie assumes no responsibility for any infringement of other rights of third parties which may result from the use of such products and information. This document supersedes and replaces all information previously supplied.

 is a registered trademark of Jiangsu JieJie Microelectronics Co.,Ltd.
Copyright ©2022 Jiangsu JieJie Microelectronics Co.,Ltd. Printed All rights reserved.