

## HF LS LI

HF LS LI | Sensors for light management systems



### Product family features

- Light and presence sensor for luminaire installation or attachment
- Presence detection via active radar sensor element
- Function indicator with two-color LED
- Motion detection range adjustable
- Mounting height: 2...13 m
- Light sensor operating range: 20...800 lx (measured at sensor)
- Integrated infrared remote control receiver
- Connection via polarity reversal protected 4p4c socket (RJ10)

### Product family benefits

- Individual activation/deactivation of light and presence sensor via remote control
- $V(\lambda)$  corrected light sensor element

### Areas of application

- Installation in IP protected luminaires possible
- Corridor lighting control in logistic centers and factory halls
- Areas with high ceilings

# Product datasheet

## Technical data

### Dimensions & weight

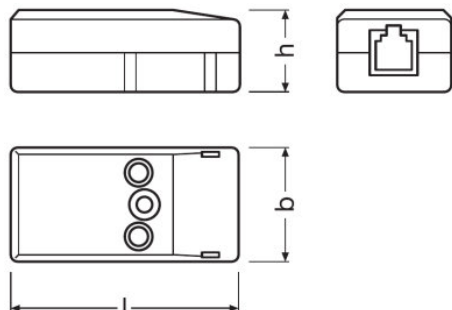

Length	56.0 mm
Width	28.0 mm
Height	21.0 mm
Product weight	22.00 g

### Colors & materials

Product color	White
---------------	-------

### Temperatures & operating conditions

Ambient temperature range	-20...+50 °C
---------------------------	--------------

### Capabilities

Maximum installation height	8 m
Detection angle	35...80 °
Operating range, light sensor	20...800 lx <sup>1)</sup>
Type of installation	Luminaire attachment/Luminaire integration

<sup>1)</sup> Approximately, measured at the sensor

### Certificates & standards

Type of protection	IP20
--------------------	------

### Logistical data

Commodity code	853650199000
----------------	--------------

### Environmental information

## Product datasheet

### Information according Art. 33 of EU Regulation (EC) 1907/2006 (REACH)

<b>Date of Declaration</b>	12-07-2022
<b>Primary Article Identifier</b>	4052899921481
<b>Candidate List Substance 1</b>	Lead
<b>CAS No. of substance 1</b>	7439-92-1
<b>Safe Use Instruction</b>	The identification of the Candidate List substance is sufficient to allow safe use of the article.
<b>Declaration No. in SCIP database</b>	fba5e52f-8202-4486-a901-b53c916e4340





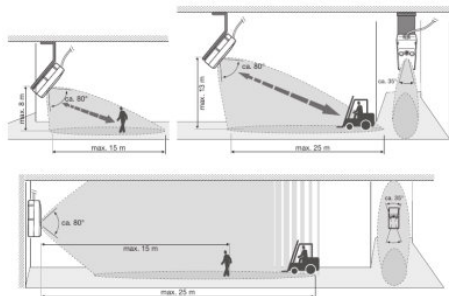

### Equipment / Accessories

- Suitable for DALIeco Control unit
- Suitable for DALI Sensor Coupler HF LS LI



490632\_HF LS LI detection range wall mounting angle

### Download Data

File	
	User instruction HF LS LI
	Brochures DALIeco: Multi-functional light management system (EN)
	Brochures Light is the efficiency booster - LED-based industrial lighting (EN)
	Brochures Light is the efficiency booster - LED-based industrial lighting (DE)
	Operating instructions 473257_Operating instructions HF LS LI
	CAD data HF LS LI CAD Data IGS

## Product datasheet



CAD data 3-dim  
HF LS LI CAD step



CAD data 3-dim  
HF LS LI CAD Data xT



CAD data PDF  
HF LS LI CAD pdf

## Logistical Data

Product code	Product description	Packaging unit (Pieces/Unit)	Dimensions (length x width x height)	Volume	Gross weight
4052899921481	HF LS LI	Shipping carton box 25	180 mm x 160 mm x 70 mm	2.02 dm <sup>3</sup>	680.00 g

The mentioned product code describes the smallest quantity unit which can be ordered. One shipping unit can contain one or more single products. When placing an order, for the quantity please enter single or multiples of a shipping unit.

## Disclaimer

Subject to change without notice. Errors and omission excepted. Always make sure to use the most recent release.