

**1A LOW DROPOUT ADJUSTABLE AND FIXED-MODE
REGULATOR WITH ENABLE & PG**
Description

The AP7361E is a 1A, adjustable and fixed output voltage, ultra-low dropout linear regulator with enable function. The device includes pass element, error amplifier, band-gap reference, current limit, and thermal shutdown circuitry. The device is turned on when the EN pin is set to logic high level.

The device's low dropout voltage and low quiescent current make it suitable for low to medium power applications, such as laptop computers, audio and video applications, and battery powered devices. The typical quiescent current is approximately 60µA. Built-in current-limit, thermal-shutdown and power good functions prevent IC from damage in fault conditions.

The AP7361E is available in the U-DFN3030-8 (Type E) package.

Features

- Wide Input Voltage Range: 2.2V to 6.0V
- Output Voltage Accuracy: ±1%
- Very Low Dropout Voltage (3.3V): 360mV at 1A Typical
- Low Quiescent Current (I_Q): 60µA Typical
- Adjustable Output Voltage Range: 0.8V to 5.0V
- Fixed Output Options: 1.0V, 1.2V, 1.5V, 1.8V, 2.5V, 2.8V and 3.3V
- High PSRR: 75dB @ 1kHz
- Current Limit: 1.5A
- Fold-Back Short Circuit Protection: 400mA
- Power-Good (PG) Output for Supply Monitoring and for Sequencing of Other Supplies
- Thermal Shutdown Protection
- Stable with MLCC, E-Cap, Tan-Cap or Solid Capacitor ≥ 2.2µF
- Ambient Temperature Range: -40°C to +85°C
- **Totally Lead-Free & Fully RoHS Compliant (Notes 1 & 2)**
- **Halogen and Antimony Free. "Green" Device (Note 3)**
- **For automotive applications requiring specific change control (i.e. parts qualified to AEC-Q100/101/200, PPAP capable, and manufactured in IATF 16949 certified facilities), please [contact us](mailto:contact@diodes.com) or your local Diodes representative. <https://www.diodes.com/quality/product-definitions/>**

- Notes:
1. No purposely added lead. Fully EU Directive 2002/95/EC (RoHS), 2011/65/EU (RoHS 2) & 2015/863/EU (RoHS 3) compliant.
 2. See <https://www.diodes.com/quality/lead-free/> for more information about Diodes Incorporated's definitions of Halogen- and Antimony-free, "Green" and Lead-free.
 3. Halogen- and Antimony-free "Green" products are defined as those which contain <900ppm bromine, <900ppm chlorine (<1500ppm total Br + Cl) and <1000ppm antimony compounds.

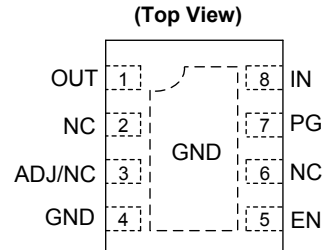
Pin Assignments

U-DFN3030-8 (Type E)
Applications

- LCD-TVs and Monitors
- Set-Top-Boxes
- Home Electrical Appliances

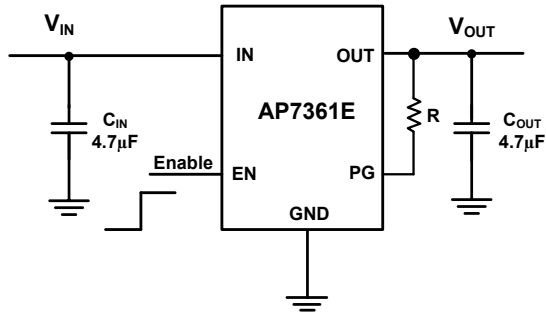
Typical Applications Circuit

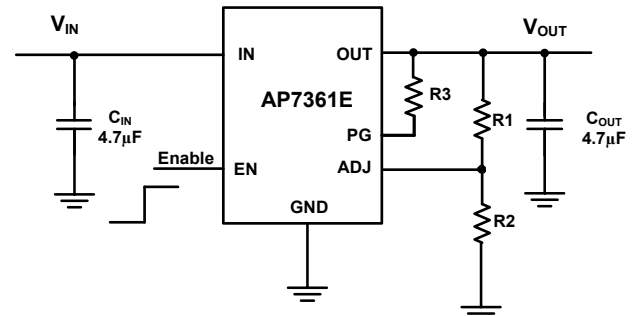

Fixed Version with EN



Adjustable Output

Pin Descriptions

Pin Number	Pin Name	Function
U-DFN3030-8 (Type E)		
1	OUT	The output of the regulator. Bypass to ground through at least 2.2µF ceramic capacitor. For improved AC load response a larger capacitor is recommended.
2, 6	NC	No connection
3	ADJ/NC	Adjustable voltage version only – a resistor divider from this pin to the OUT pin and ground sets the output voltage.
4	GND	Ground
5	EN	Enable input, active high
7	PG	Power-Good pin, open-drain output. When the V_{OUT} is below the PG threshold the PG pin is driven low; when the V_{OUT} exceeds the threshold, the PG pin goes into a high-impedance state. To use the PG pin, use a 10kΩ to 1MΩ pull-up resistor to pull it up to a supply of up to 6V, which can be higher than the input voltage.
8	IN	The input of the regulator. Bypass to ground through at least 1µF ceramic capacitor.

Functional Block Diagram

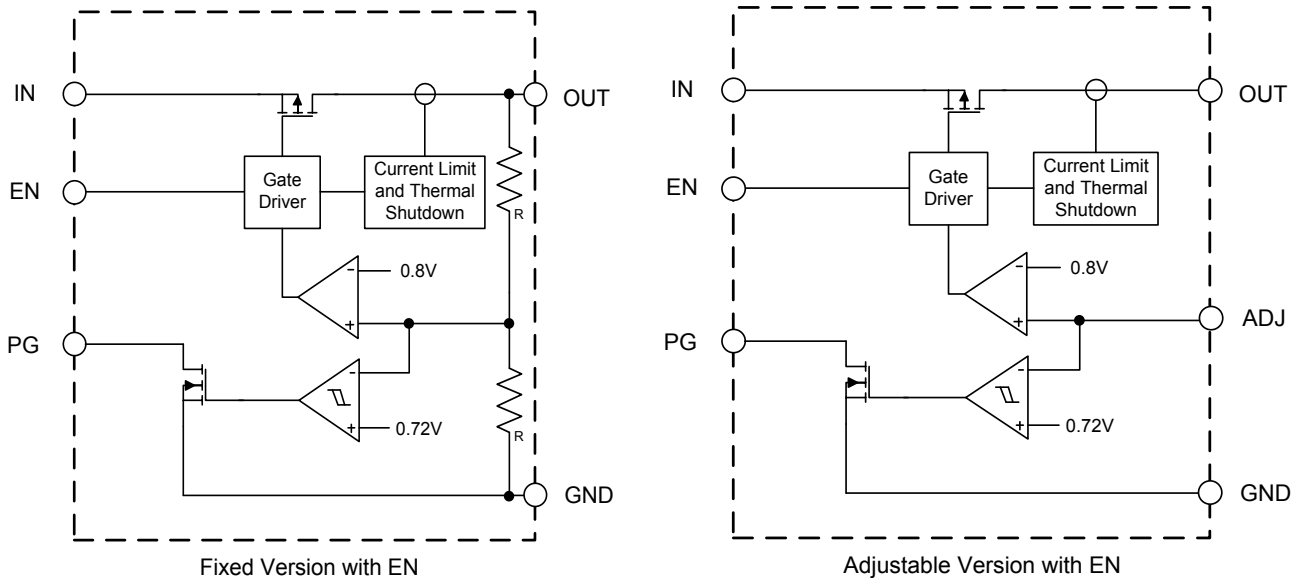

Absolute Maximum Ratings (@ $T_A = +25^\circ\text{C}$, unless otherwise specified.) (Note 4)

Symbol	Parameter	Rating	Unit
V_{IN}	Input Voltage	6.5	V
—	OUT, ADJ, EN Voltage	$V_{IN} + 0.3$	V
T_J	Operating Junction Temperature Range	-40 to +150	$^\circ\text{C}$
T_{STG}	Storage Temperature Range	-65 to +150	$^\circ\text{C}$
P_D	Power Dissipation	Internally limited by maximum junction temperature of +150 $^\circ\text{C}$	—
P_D	Power Dissipation	U-DFN3030-8 (Type E)	1700
ESD HBM	Human Body Model ESD Protection	> 2	kV
ESD CDM	Charge Device Model	± 1500	V

Note: 4. Stresses greater than the *Absolute Maximum Ratings* specified above can cause permanent damage to the device. These are stress ratings only; functional operation of the device at these or any other conditions exceeding those indicated in this specification is not implied. Device reliability can be affected by exposure to absolute maximum rating conditions for extended periods of time.

Recommended Operating Conditions (@ $T_A = +25^\circ\text{C}$, unless otherwise specified.)

Symbol	Parameter	Min	Max	Unit
V_{IN}	Input Voltage	2.2	6.0	V
V_{OUT}	Output Voltage	0.8	5.0	V
I_{OUT}	Output Current (Note 5)	0	1.0	A
T_A	Operating Ambient Temperature	-40	+85	$^\circ\text{C}$

Note: 5. The device maintains a stable, regulated output voltage without a load current. When the output current is large, attention should be given to the limitation of the package power dissipation.

Electrical Characteristics (@ $T_A = +25^\circ\text{C}$, $V_{IN} = V_{OUT} + 1\text{V}$, $C_{IN} = 4.7\mu\text{F}$, $C_{OUT} = 4.7\mu\text{F}$, $V_{EN} = V_{IN}$, unless otherwise specified.)

Symbol	Parameter	Test Conditions	Min	Typ	Max	Unit	
V_{REF}	FB Reference Voltage, ADJ Pin	$I_{OUT} = 10\text{mA}$, $T_A = +25^\circ\text{C}$	0.792	0.8	0.808	V	
I_{ADJ}	ADJ Pin Leakage Current	—	—	0.1	0.5	μA	
I_Q	Input Quiescent Current	Enabled, $I_{OUT} = 0\text{A}$	—	68	91	μA	
I_{SHDN}	Input Shutdown Current	$V_{EN} = 0\text{V}$, $I_{OUT} = 0\text{A}$	-1	0.05	1	μA	
V_{OUT}	Output Voltage Accuracy	$I_{OUT} = 100\text{mA}$, $T_A = +25^\circ\text{C}$	$1.0\text{V} \leq V_{OUT} < 1.5\text{V}$	$V_{OUT(s)-}$ 0.015	$V_{OUT(s)}$	$V_{OUT(s)+}$ 0.015	V
			$1.5\text{V} \leq V_{OUT} \leq 3.3\text{V}$	$V_{OUT(s)*}$ 0.99	$V_{OUT(s)}$	$V_{OUT(s)*}$ 1.01	
$\frac{\Delta V_{OUT}}{\Delta V_{IN} \times V_{OUT}}$	Line Regulation	$V_{IN} = V_{OUT} + 1\text{V}$ to 5.5V , $I_{OUT} = 100\text{mA}$	$T_A = +25^\circ\text{C}$	—	0.01	0.1	% / V
			$-40^\circ\text{C} \leq T_A \leq +85^\circ\text{C}$	—	—	0.2	
$\Delta V_{OUT} / V_{OUT}$	Load Regulation	I_{OUT} from 1.0mA to 1A	$1.2\text{V} < V_{OUT} \leq 3.3\text{V}$	-1.0	—	1.0	%
			$1.0\text{V} \leq V_{OUT} \leq 1.2\text{V}$	-1.5	—	1.5	%
$V_{DROPOUT}$	Dropout Voltage	$I_{OUT} = 300\text{mA}$	$1.0\text{V} \leq V_{OUT} < 1.1\text{V}$	—	710	(Note 6)	mV
			$1.1\text{V} \leq V_{OUT} < 1.2\text{V}$	—	600	(Note 6)	
			$1.2\text{V} \leq V_{OUT} < 1.3\text{V}$	—	500	(Note 6)	
			$1.3\text{V} \leq V_{OUT} < 1.4\text{V}$	—	400	(Note 6)	
			$1.4\text{V} \leq V_{OUT} < 1.5\text{V}$	—	300	(Note 6)	
			$1.5\text{V} \leq V_{OUT} < 2.0\text{V}$	—	200	(Note 6)	
			$2.0\text{V} \leq V_{OUT} < 2.6\text{V}$	—	140	250	
			$2.6\text{V} \leq V_{OUT} \leq 3.3\text{V}$	—	90	140	
		$I_{OUT} = 1\text{A}$	$1.0\text{V} \leq V_{OUT} < 1.1\text{V}$	—	840	(Note 6)	
			$1.1\text{V} \leq V_{OUT} < 1.2\text{V}$	—	780	(Note 6)	
			$1.2\text{V} \leq V_{OUT} < 1.3\text{V}$	—	710	(Note 6)	
			$1.3\text{V} \leq V_{OUT} < 1.4\text{V}$	—	660	(Note 6)	
			$1.4\text{V} \leq V_{OUT} < 1.5\text{V}$	—	610	(Note 6)	
			$1.5\text{V} \leq V_{OUT} < 2.0\text{V}$	—	570	(Note 6)	
			$2.0\text{V} \leq V_{OUT} < 2.6\text{V}$	—	440	600	
			$2.6\text{V} \leq V_{OUT} \leq 3.3\text{V}$	—	340	500	
t_D	Output Voltage Turn On Delay Time	$V_{IN} = V_{OUT} + 1\text{V}$, V_{EN} High to V_{OUT} Rising 10%	—	50	—	μs	
t_{SS}	Output Voltage Ramp Up Time	V_{OUT} Rising 10% to 90%	—	200	—	μs	
t_{PG}	PG React Time	V_{OUT} 90% to PG Active	—	30	—	μs	
t_{PGF}	PG Off Deglitch Time	ADJ Falling to PG Low	—	3	—	μs	
		EN Goes Low to PG Low					
V_{PGR}	PG Rising Threshold	ADJ Rising	89	92	95	%	
V_{PGF}	PG Falling Threshold	ADJ Falling	79	82	85	%	
V_{PGS}	PG Sinking Voltage	$V_{IN} = 3.3\text{V}$, Sinking Current = 5mA	—	—	0.4	V	
V_{IL}	EN Input Logic Low Voltage	—	0	—	0.3	V	
V_{IH}	EN Input Logic High Voltage	—	1.0	—	V_{IN}	V	
R_{ENPD}	EN Pull-Down Resistor	—	—	3.0	—	M Ω	
I_{EN}	EN Input Leakage Current	$V_{IN} = 5.5\text{V}$, $V_{EN} = 0\text{V}$	-0.1	—	0.1	μA	
R_{PD}	Output Discharge Resistor	$V_{OL} = 1\text{V}$	—	100	—	Ω	
I_{OUT}	Maximum Output Current	$V_{IN} = V_{OUT} + 1\text{V}$	1.0	—	—	A	

Notes: 6. Dropout voltage is the voltage difference between the input and the output at which the output voltage drops 2% below its nominal value. This parameter only applies to output voltages above 2.0V since minimum $V_{IN} = 2.2\text{V}$.

Electrical Characteristics (@ $T_A = +25^\circ\text{C}$, $V_{IN} = V_{OUT} + 1\text{V}$, $C_{IN} = 4.7\mu\text{F}$, $C_{OUT} = 4.7\mu\text{F}$, $V_{EN} = V_{IN}$, unless otherwise specified.)
(continued)

Symbol	Parameter	Test Conditions	Min	Typ	Max	Unit
I_{LIMIT}	Current Limit	$V_{IN} = V_{OUT} + 1\text{V}$ ($V_{IN\ MINI} = 2.2\text{V}$)	1.3	1.5	—	A
I_{SHORT}	Short-Circuit Current	$V_{IN} = V_{OUT} + 1\text{V}$, Output Voltage < 15% V_{OUT}	—	400	—	mA
PSRR	Power Supply Rejection Ratio (Note 7)	$f = 1\text{kHz}$, $I_{OUT} = 100\text{mA}$, $V_{OUT} = 1.2\text{V}$	—	75	—	dB
		$f = 10\text{kHz}$, $I_{OUT} = 100\text{mA}$, $V_{OUT} = 1.2\text{V}$	—	55	—	
t_{ST}	Start-Up Time	$V_{OUT} = 3\text{V}$, $C_{OUT} = 2.2\mu\text{F}$, $R_L = 30\Omega$	—	150	—	μs
$\frac{\Delta V_{OUT}}{\Delta T_A \times V_{OUT}}$	Output Voltage Temperature Coefficient	$I_{OUT} = 100\text{mA}$, $-40^\circ\text{C} \leq T_A \leq +85^\circ\text{C}$	—	± 100	—	ppm/ $^\circ\text{C}$
T_{SHDN}	Thermal Shutdown Threshold	—	—	+150	—	$^\circ\text{C}$
T_{HYS}	Thermal Shutdown Hysteresis	—	—	+20	—	$^\circ\text{C}$
θ_{JA}	Thermal Resistance Junction-to-Ambient	U-DFN3030-8 (Type E) (Note 8)	—	70	—	$^\circ\text{C/W}$

- Notes:
7. For $V_{IN} \geq 2.5\text{V}$ and $V_{IN} = V_{OUT} + 1\text{V}$. For $V_{IN} < 2.5\text{V}$, the PSRR performance may be reduced.
 8. Test condition: U-DFN3030-8 (Type E) device is mounted on 2" x 2", FR-4 substrate PCB, with minimum recommended pad on top layer and thermal vias to bottom layer ground plane.

Typical Characteristics

Start-up Time
 $V_{OUT}=3V @ I_{OUT}=50mA$

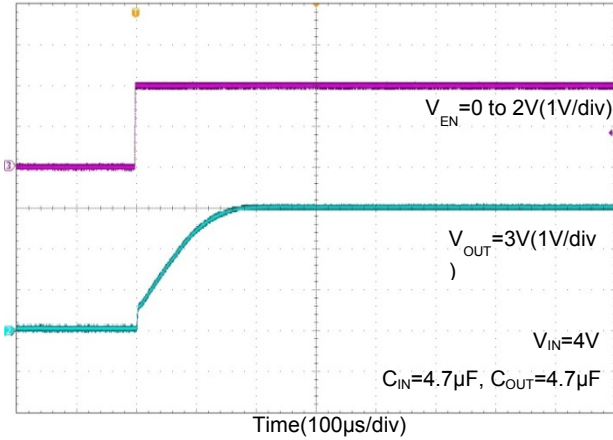

Start-up Time
 $V_{OUT}=3V @ I_{OUT}=100mA$

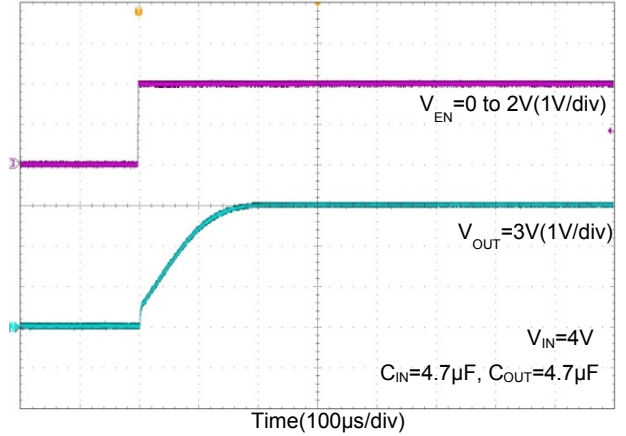

Line Transient Response
 $V_{OUT}=1.2V$

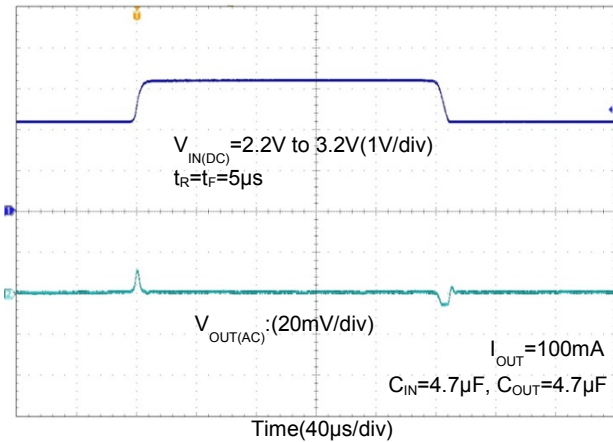

Line Transient Response
 $V_{OUT}=2.5V$

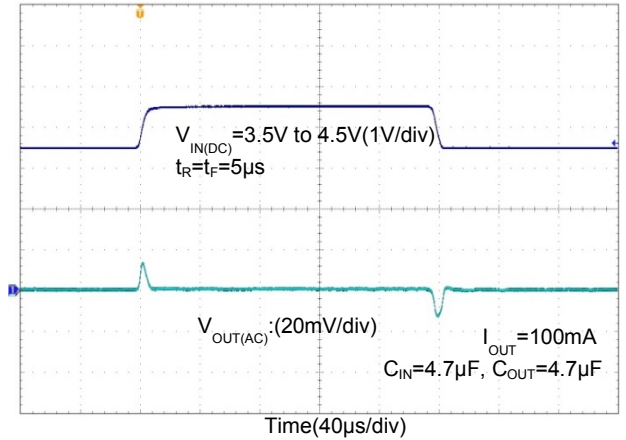

Line Transient Response
 $V_{OUT}=3.3V$

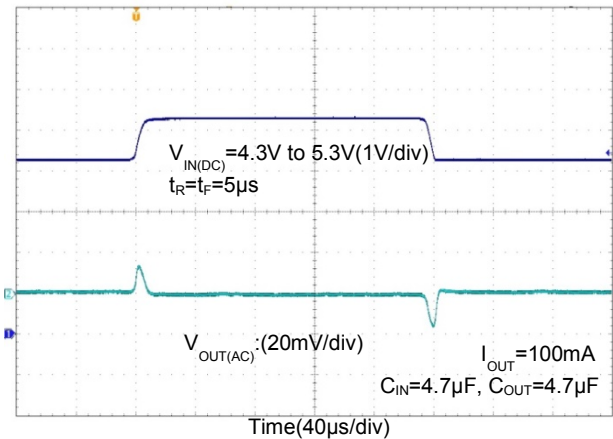

Typical Characteristics (continued)

Load Transient Response
 $V_{OUT}=1.2V$

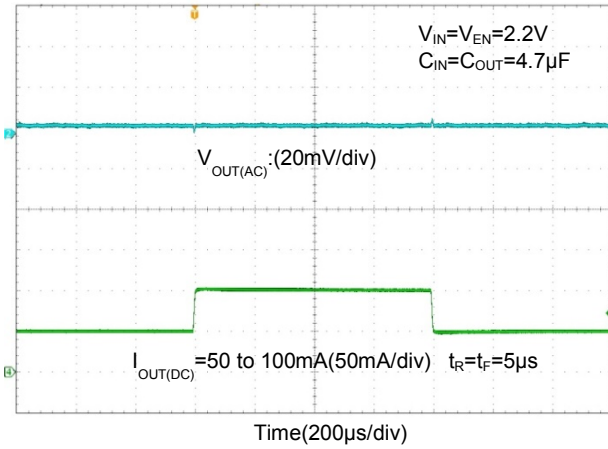

Load Transient Response
 $V_{OUT}=1.2V$

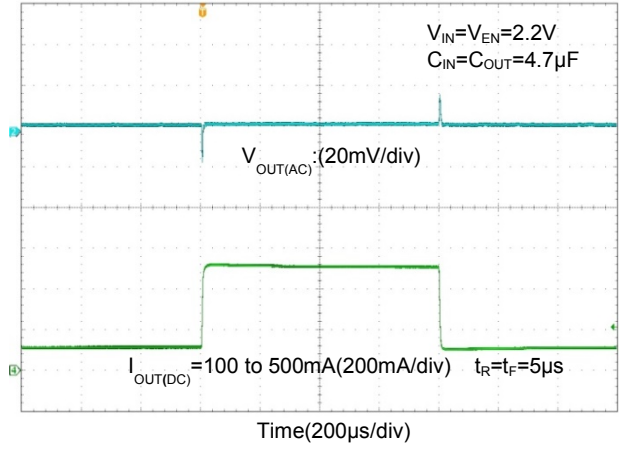

Load Transient Response
 $V_{OUT}=2.5V$

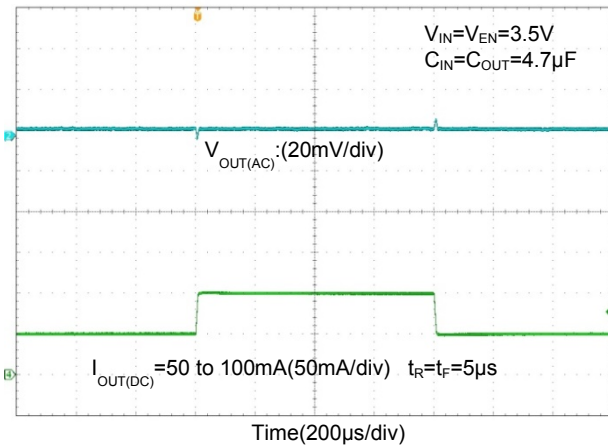

Load Transient Response
 $V_{OUT}=2.5V$

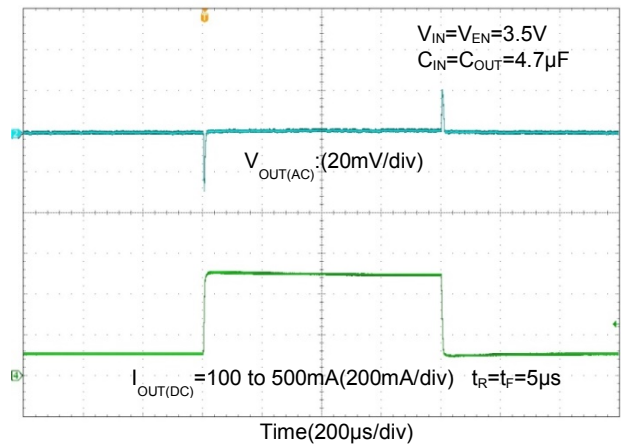

Load Transient Response
 $V_{OUT}=3.3V$

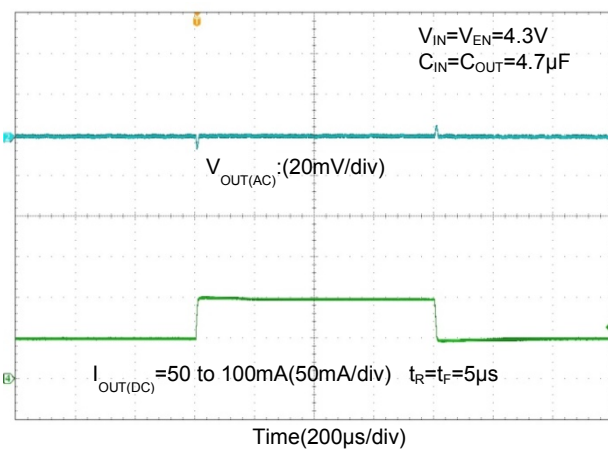

Load Transient Response
 $V_{OUT}=3.3V$

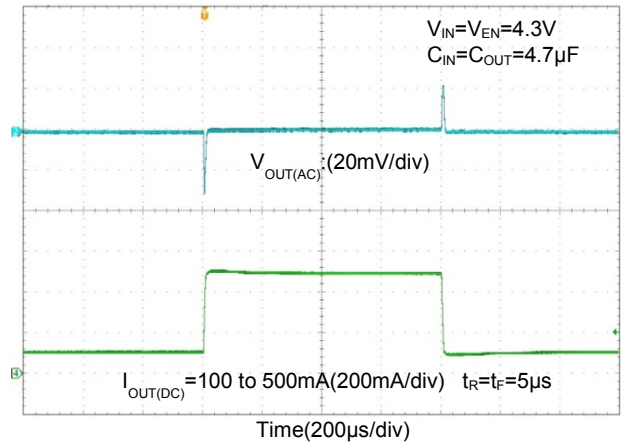

Typical Characteristics (continued)

Enable Turn-On Response
 $V_{OUT}=1.2V$

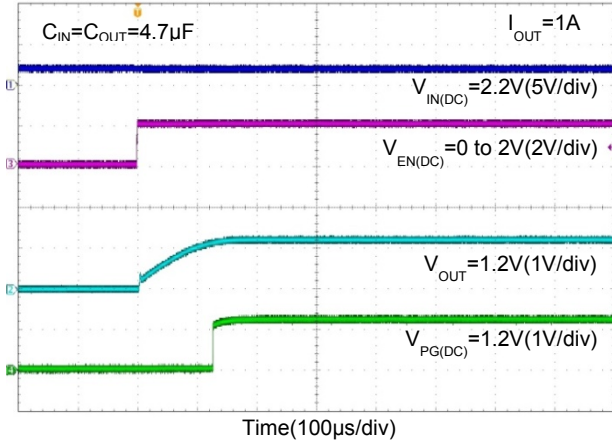

Enable Turn-Off Response
 $V_{OUT}=1.2V$

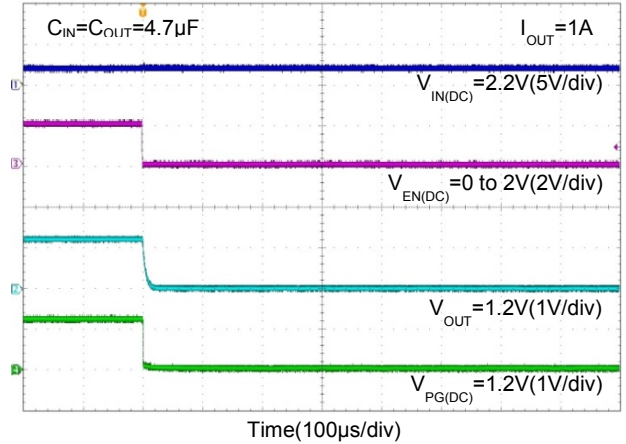

Enable Turn-On Response
 $V_{OUT}=2.5V$

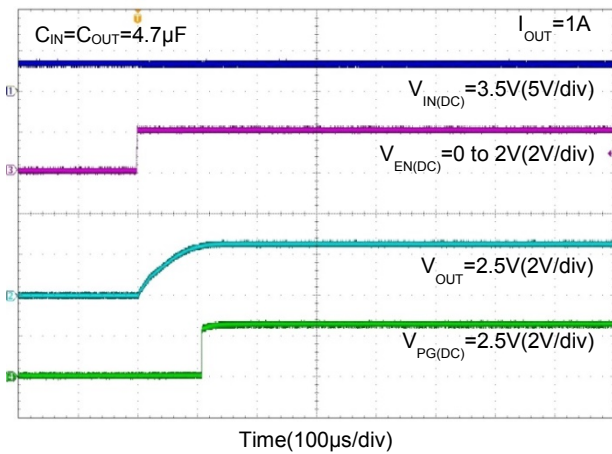

Enable Turn-Off Response
 $V_{OUT}=2.5V$

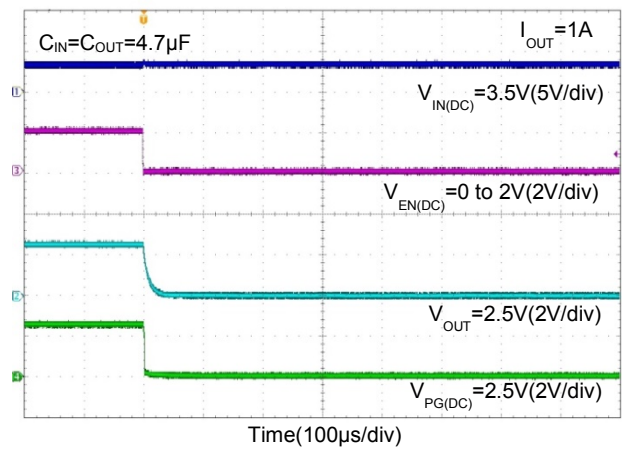

Enable Turn-On Response
 $V_{OUT}=3.3V$

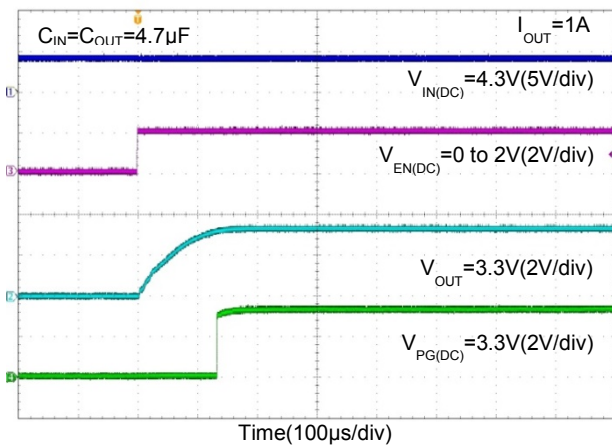

Enable Turn-Off Response
 $V_{OUT}=3.3V$

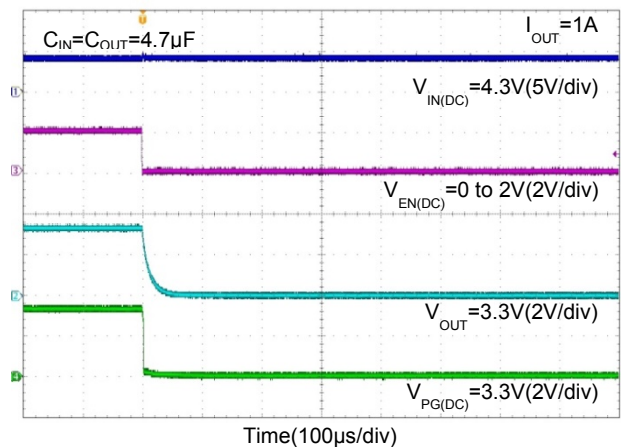

Typical Characteristics (continued)

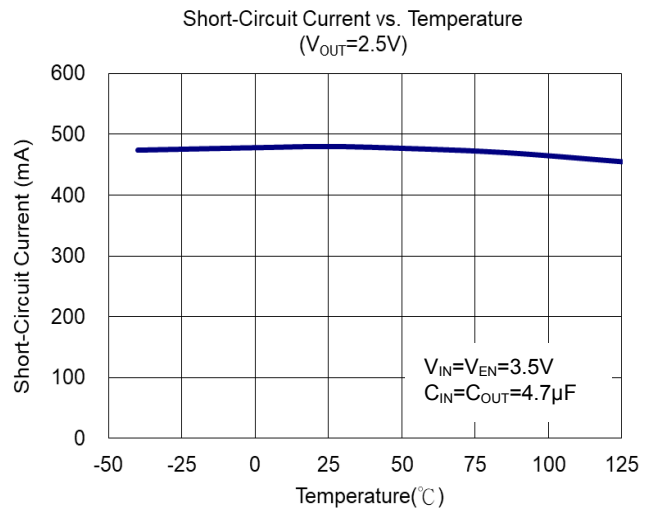
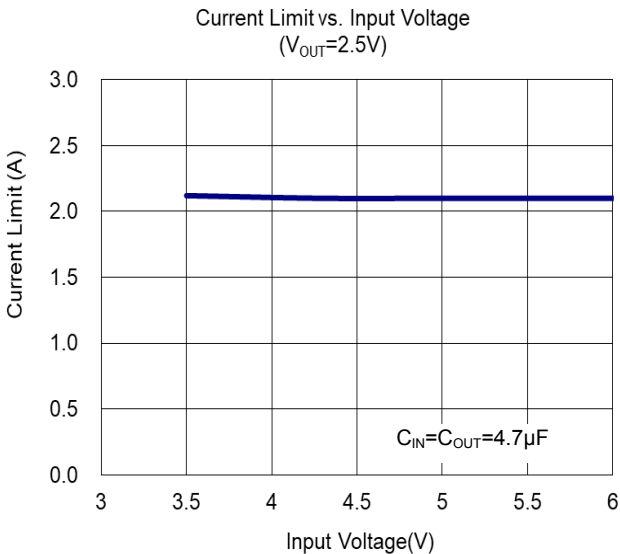
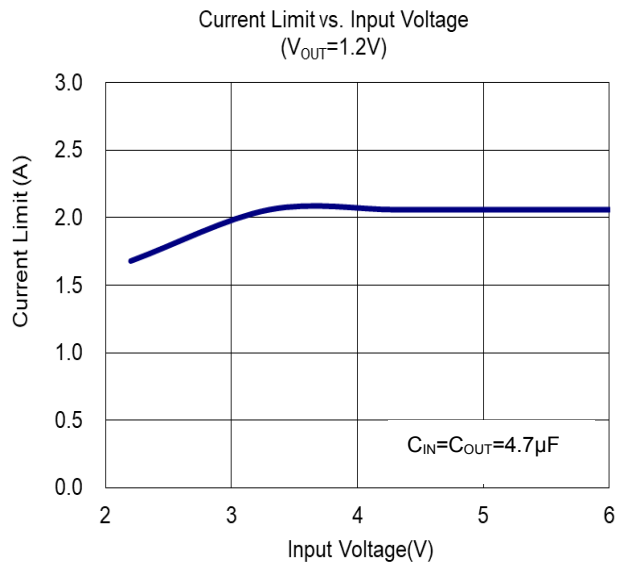
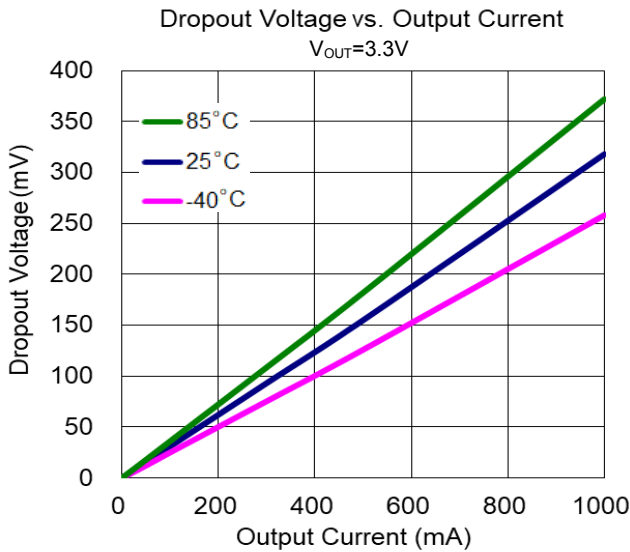
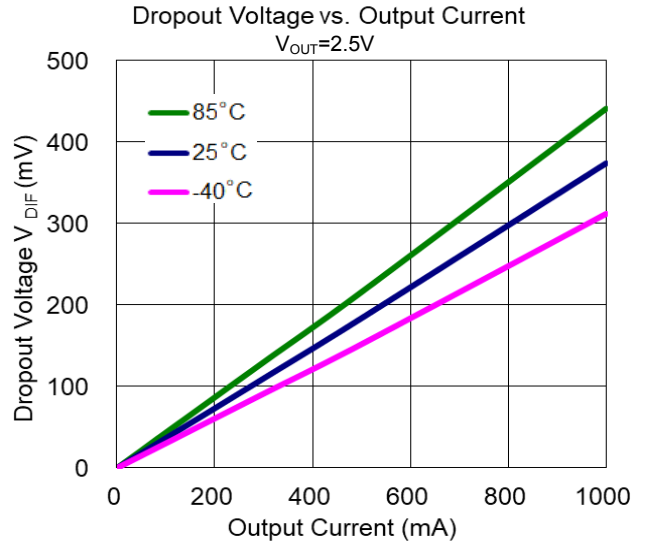
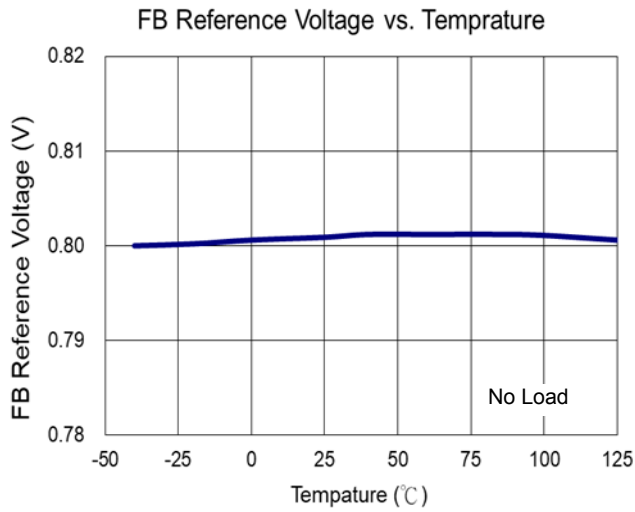

Typical Characteristics (continued)

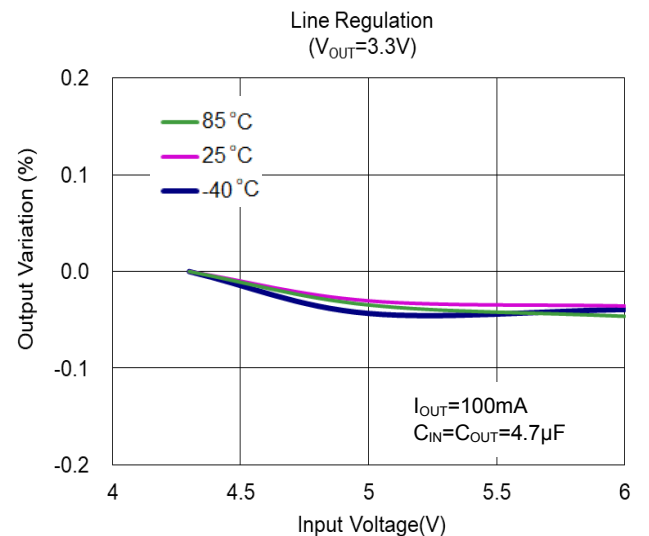
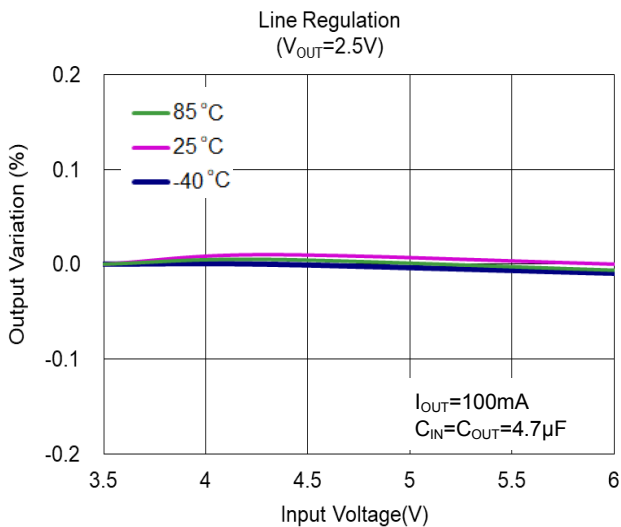
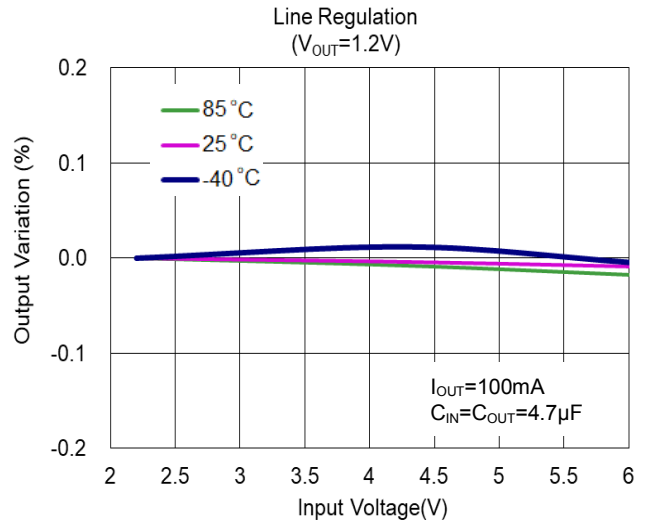
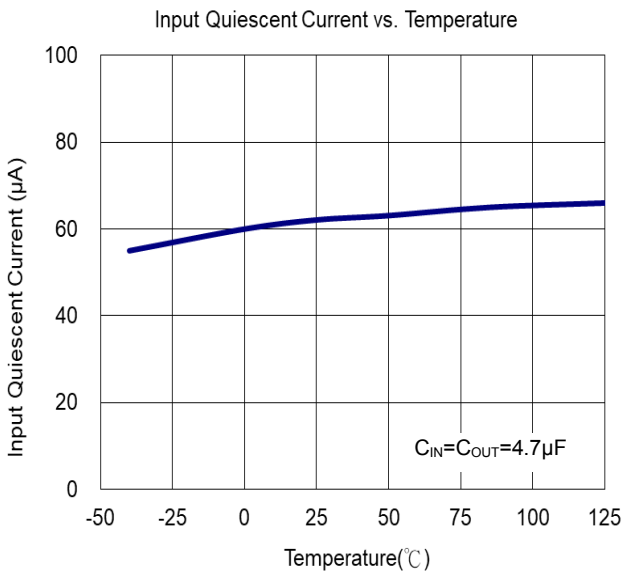
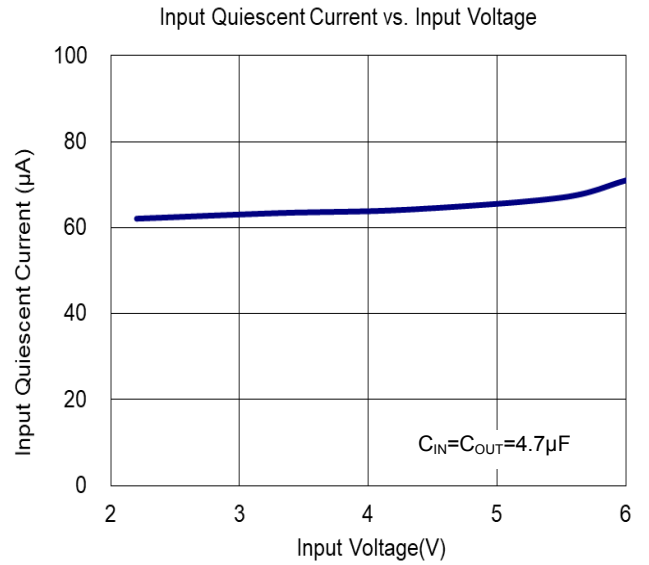
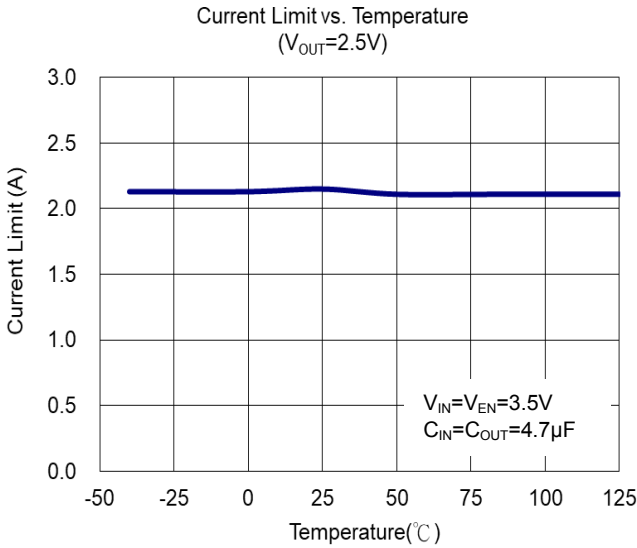

Typical Characteristics (continued)

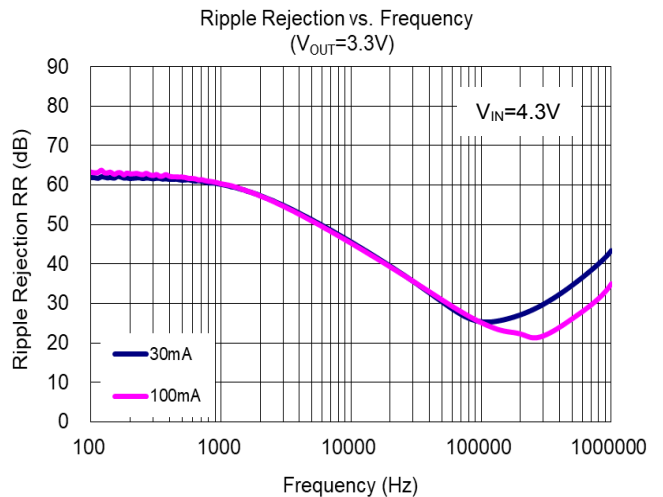
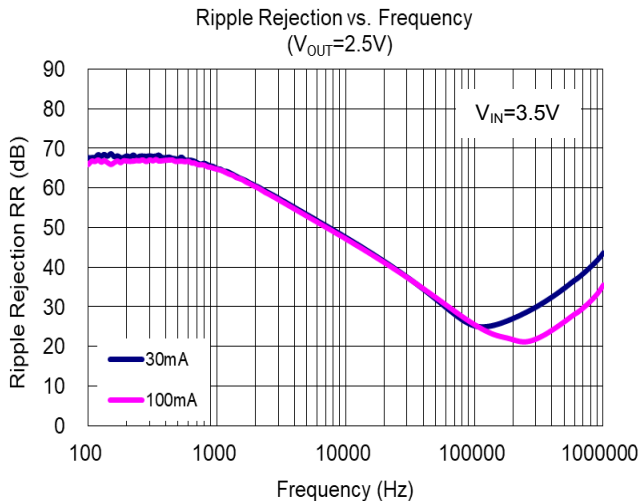
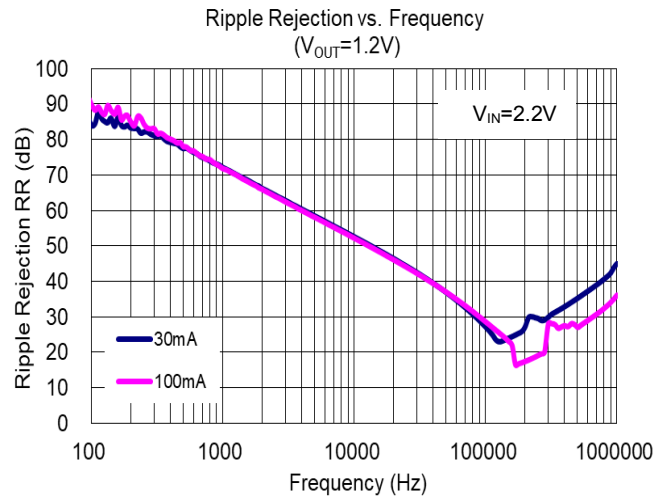
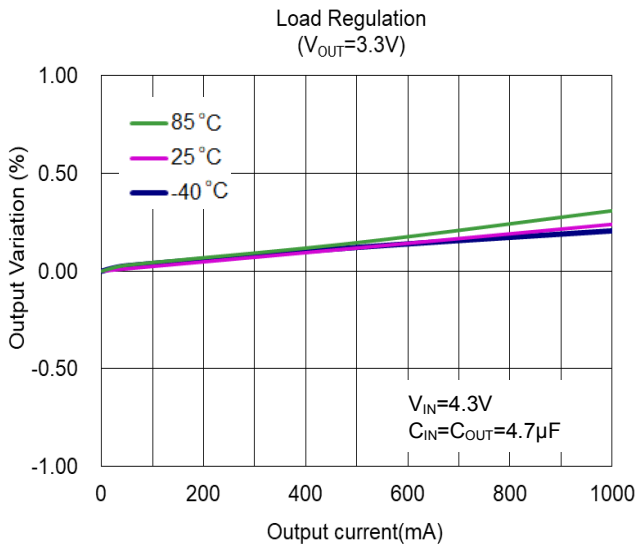
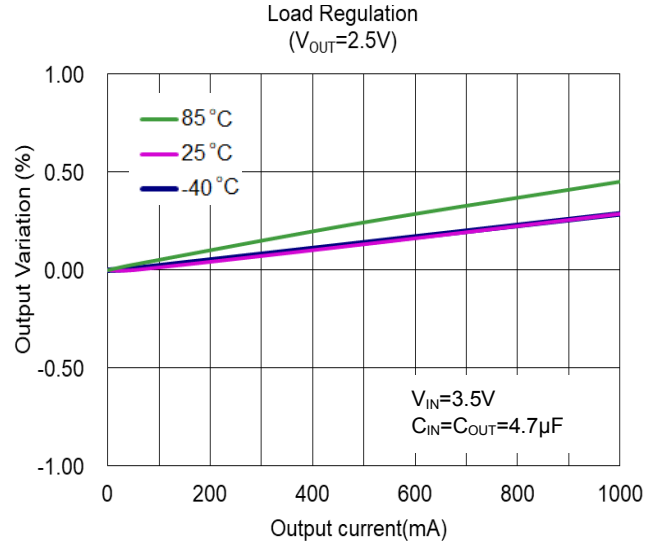
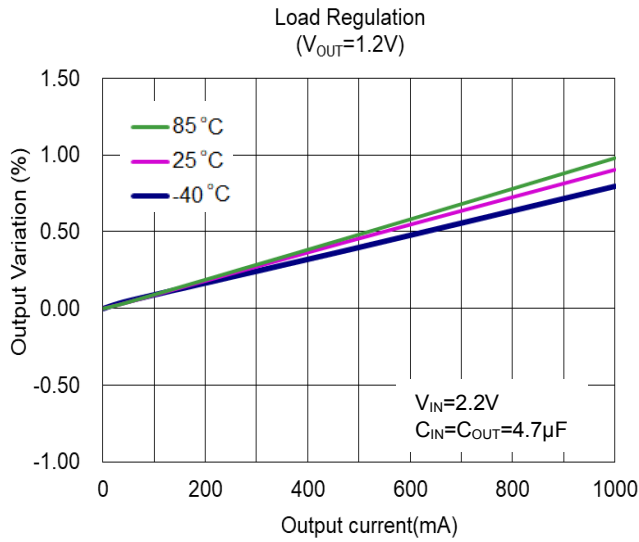

Application Information

Input Capacitor

A 1 μ F ceramic capacitor is recommended between IN and GND pins to decouple input power supply glitch and noise. The amount of the capacitance may be increased without limit. This input capacitor must be located as close as possible to the device to assure input stability and reduce noise. For PCB layout, a wide copper trace is required for both IN and GND pins. A lower ESR capacitor type allows the use of less capacitance, while higher ESR type requires more capacitance.

Output Capacitor

Ceramic type output capacitor is recommended for this series; however, the other output capacitors with low ESR also can be used. The relations between I_{OUT} (Output Current) and ESR of an output capacitor are shown below. The stable region for the safety operating temperature (-40°C ~ +85°C) is marked as the gray area in the graph.

Measurement conditions: Frequency Band: 10Hz to 2MHz, Temperature: -40°C to +85°C.

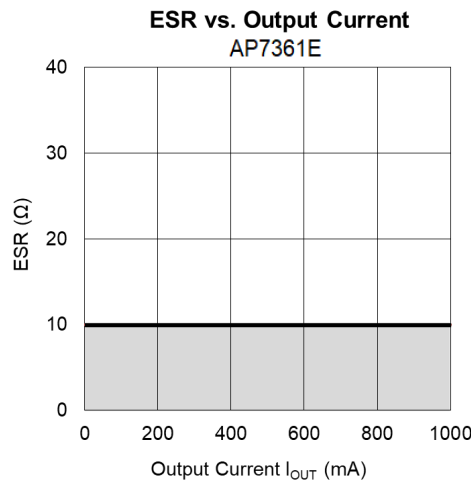

Adjustable Operation

The AP7361E provides output voltage from 0.8V to 5.0V through external resistor divider as shown below.

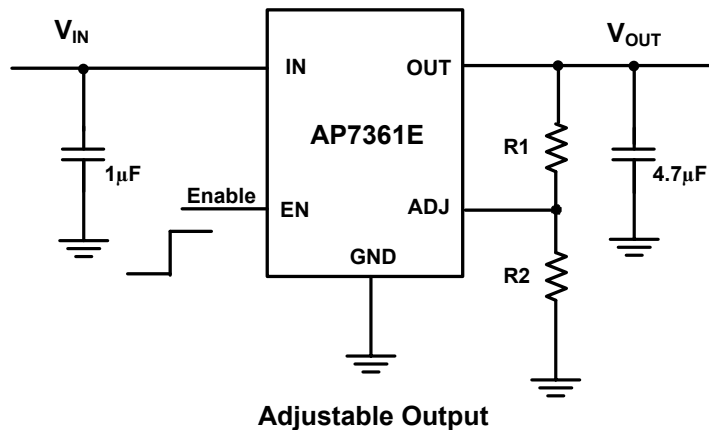

Application Information (continued)

The output voltage is calculated by:

$$V_{OUT} = V_{REF} \left(1 + \frac{R_1}{R_2} \right)$$

Where $V_{REF} = 0.8V$ (the internal reference voltage).

Rearranging the equation will give the following that is used for adjusting the output to a particular voltage:

$$R_1 = R_2 \left(\frac{V_{OUT}}{V_{REF}} - 1 \right)$$

To maintain the stability of the internal reference voltage, R2 needs to be kept smaller than 80kΩ.

No Load Stability

Other than external resistor divider, no minimum load is required to keep the device stable. The device will remain stable and regulated in no load condition.

ON/OFF Input Operation

The AP7361E is turned on by setting the EN pin high, and is turned off by pulling it low. If this feature is not used, the EN pin should be tied to IN pin to keep the regulator output on at all time. To ensure proper operation, the signal source used to drive the EN pin must be able to swing above and below the specified turn-on/off voltage thresholds listed in the *Electrical Characteristics* section under V_{IL} and V_{IH} .

Current Limit Protection

When output current at OUT pin is higher than current limit threshold, the current limit protection will be triggered and clamp the output current to prevent over-current and to protect the regulator from damage due to overheating.

Short Circuit Protection

When OUT pin is short-circuit to GND, short circuit protection will be triggered and clamp the output current to approximately 400mA. Full current is restored when the output voltage exceeds 15% of V_{OUT} . This feature protects the regulator from over-current and damage due to overheating.

Power Good

The power-good (PG) pin is an open-drain output and can be pulled up through a resistor of 10kΩ to 1MΩ to V_{IN} , V_{OUT} or any other rail that is 6V or lower. When the $V_{OUT} \geq V_{PGR}$, the PG output is high-impedance; if the V_{OUT} drops to below V_{PGF} , or the device is disabled, the PG pin is pulled to low by an internal MOSFET.

Thermal Shutdown Protection

Thermal protection disables the output when the junction temperature rises to approximately +150°C, allowing the device to cool down. When the junction temperature reduces to approximately +130°C the output circuitry is enabled again. Depending on power dissipation, thermal resistance, and ambient temperature, the thermal protection circuit may cycle on and off. This cycling limits the heat dissipation of the regulator, protecting it from damage due to overheating.

Ultra Fast Start-up

After enabled, the AP7361E is able to provide full power in as little as tens of microseconds, typically 200μs, without sacrificing low ground current. This feature will help load circuitry move in and out of standby mode in real time, eventually extend battery life for mobile phones and other portable devices.

Low Quiescent Current

The AP7361E, consuming only around 60μA for all input range, provides great power saving in portable and low power applications.

Power Dissipation

The device power dissipation and proper sizing of the thermal plane that is connected to the thermal pad is critical to avoid thermal shutdown and ensure reliable operation. Power dissipation of the device depends on input voltage and load conditions and can be calculated by:

$$P_D = (V_{IN} - V_{OUT}) \times I_{OUT}$$

The maximum power dissipation, handled by the device, depends on the maximum junction to ambient thermal resistance, maximum ambient temperature, and maximum device junction temperature, which can be calculated by the equation in the following:

$$P_D(\max@T_A) = \frac{(+150^\circ\text{C} - T_A)}{R_{\theta JA}}$$

Ordering Information

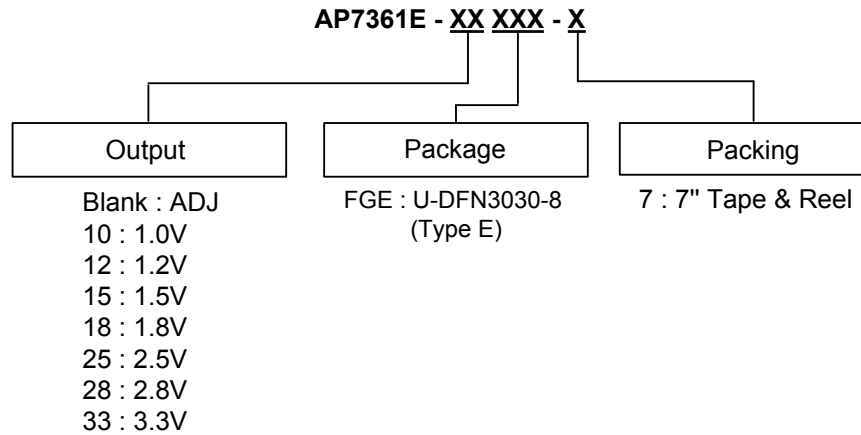

Part Number	Package Code (Note 9)	Packaging	7" Tape and Reel	
			Quantity	Part Number Suffix
AP7361E-XFGE-7	FGE	U-DFN3030-8 (Type E)	3000/Tape & Reel	-7

Note: 9. For packaging details, go to our website at <https://www.diodes.com/design/support/packaging/diodes-packaging/>.

Marking Information

(Top View)

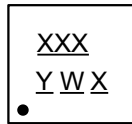

XXX : Identification Code
Y : Year : 0~9
W : Week : A~Z : 1~26 week;
 a~z : 27~52 week; z represents
 52 and 53 week
X : Internal Code

Part Number	Package	Identification Code
AP7361E-FGE-7	U-DFN3030-8 (Type E)	C9A
AP7361E-10FGE-7	U-DFN3030-8 (Type E)	C9B
AP7361E-12FGE-7	U-DFN3030-8 (Type E)	C9C
AP7361E-15FGE-7	U-DFN3030-8 (Type E)	C9D
AP7361E-18FGE-7	U-DFN3030-8 (Type E)	C9E
AP7361E-25FGE-7	U-DFN3030-8 (Type E)	C9F
AP7361E-28FGE-7	U-DFN3030-8 (Type E)	C9G
AP7361E-33FGE-7	U-DFN3030-8 (Type E)	C9H

Package Outline Dimensions

Please see <http://www.diodes.com/package-outlines.html> for the latest version.

U-DFN3030-8 (Type E)

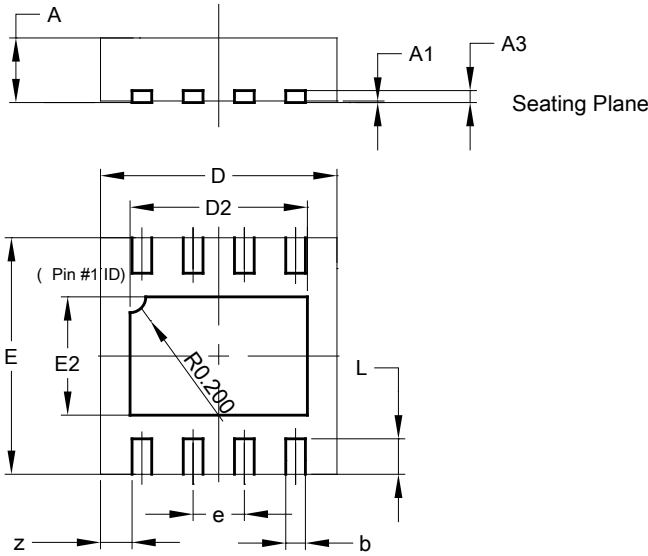

U-DFN3030-8 (Type E)			
Dim	Min	Max	Typ
A	0.57	0.63	0.60
A1	0.00	0.05	0.02
A3	-	-	0.15
b	0.20	0.30	0.25
D	2.95	3.05	3.00
D2	2.15	2.35	2.25
E	2.95	3.05	3.00
E2	1.40	1.60	1.50
e	-	-	0.65
L	0.30	0.60	0.45
z	-	-	0.40
All Dimensions in mm			

Suggested Pad Layout

Please see <http://www.diodes.com/package-outlines.html> for the latest version.

U-DFN3030-8 (Type E)

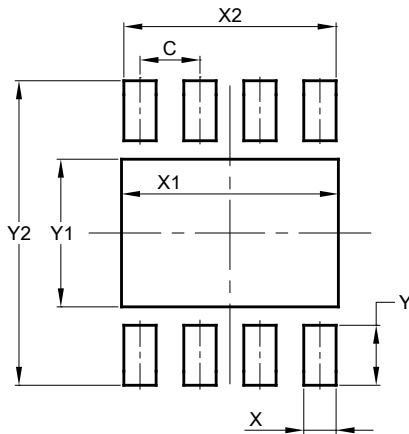

Dimensions	Value (in mm)
C	0.650
X	0.350
X1	2.350
X2	2.300
Y	0.650
Y1	1.600
Y2	3.300

Mechanical Data

- Moisture Sensitivity: Level 1 per J-STD-020
- Terminals: NiPdAu over Copper Leads, Solderable per MIL-STD-202, Method 208 ④
- Weight: 0.0164 grams (Approximate)

IMPORTANT NOTICE

1. DIODES INCORPORATED AND ITS SUBSIDIARIES (“DIODES”) MAKE NO WARRANTY OF ANY KIND, EXPRESS OR IMPLIED, WITH REGARDS TO ANY INFORMATION CONTAINED IN THIS DOCUMENT, INCLUDING, BUT NOT LIMITED TO, THE IMPLIED WARRANTIES OF MERCHANTABILITY, FITNESS FOR A PARTICULAR PURPOSE OR NON-INFRINGEMENT OF THIRD PARTY INTELLECTUAL PROPERTY RIGHTS (AND THEIR EQUIVALENTS UNDER THE LAWS OF ANY JURISDICTION).
2. The Information contained herein is for informational purpose only and is provided only to illustrate the operation of Diodes products described herein and application examples. Diodes does not assume any liability arising out of the application or use of this document or any product described herein. This document is intended for skilled and technically trained engineering customers and users who design with Diodes products. Diodes products may be used to facilitate safety-related applications; however, in all instances customers and users are responsible for (a) selecting the appropriate Diodes products for their applications, (b) evaluating the suitability of the Diodes products for their intended applications, (c) ensuring their applications, which incorporate Diodes products, comply the applicable legal and regulatory requirements as well as safety and functional-safety related standards, and (d) ensuring they design with appropriate safeguards (including testing, validation, quality control techniques, redundancy, malfunction prevention, and appropriate treatment for aging degradation) to minimize the risks associated with their applications.
3. Diodes assumes no liability for any application-related information, support, assistance or feedback that may be provided by Diodes from time to time. Any customer or user of this document or products described herein will assume all risks and liabilities associated with such use, and will hold Diodes and all companies whose products are represented herein or on Diodes’ websites, harmless against all damages and liabilities.
4. Products described herein may be covered by one or more United States, international or foreign patents and pending patent applications. Product names and markings noted herein may also be covered by one or more United States, international or foreign trademarks and trademark applications. Diodes does not convey any license under any of its intellectual property rights or the rights of any third parties (including third parties whose products and services may be described in this document or on Diodes’ website) under this document.
5. Diodes products are provided subject to Diodes’ Standard Terms and Conditions of Sale (<https://www.diodes.com/about/company/terms-and-conditions/terms-and-conditions-of-sales/>) or other applicable terms. This document does not alter or expand the applicable warranties provided by Diodes. Diodes does not warrant or accept any liability whatsoever in respect of any products purchased through unauthorized sales channel.
6. Diodes products and technology may not be used for or incorporated into any products or systems whose manufacture, use or sale is prohibited under any applicable laws and regulations. Should customers or users use Diodes products in contravention of any applicable laws or regulations, or for any unintended or unauthorized application, customers and users will (a) be solely responsible for any damages, losses or penalties arising in connection therewith or as a result thereof, and (b) indemnify and hold Diodes and its representatives and agents harmless against any and all claims, damages, expenses, and attorney fees arising out of, directly or indirectly, any claim relating to any noncompliance with the applicable laws and regulations, as well as any unintended or unauthorized application.
7. While efforts have been made to ensure the information contained in this document is accurate, complete and current, it may contain technical inaccuracies, omissions and typographical errors. Diodes does not warrant that information contained in this document is error-free and Diodes is under no obligation to update or otherwise correct this information. Notwithstanding the foregoing, Diodes reserves the right to make modifications, enhancements, improvements, corrections or other changes without further notice to this document and any product described herein. This document is written in English but may be translated into multiple languages for reference. Only the English version of this document is the final and determinative format released by Diodes.
8. Any unauthorized copying, modification, distribution, transmission, display or other use of this document (or any portion hereof) is prohibited. Diodes assumes no responsibility for any losses incurred by the customers or users or any third parties arising from any such unauthorized use.

Copyright © 2021 Diodes Incorporated

www.diodes.com

Mouser Electronics

Authorized Distributor

Click to View Pricing, Inventory, Delivery & Lifecycle Information:

[Diodes Incorporated:](#)

[AP7361E-FGE-7](#)