

3A, 1MHz, 6V CMCOT Synchronous Step-Down Converter

Purpose

The RT5797A is a high efficiency synchronous step-down DC-DC converter. Its input voltage range is from 2.7V to 6V and provides an adjustable regulated output voltage from 0.6V to 3.4V while delivering up to 3A of output current. This document explains the function and use of the RT5797A evaluation board (EVB), and provides information to enable operation, modification of the evaluation board and circuit to suit individual requirements.

Table of Contents

Purpose.....	1
Introduction.....	2
Bench Test Setup Conditions	3
Schematic, Bill of Materials & Board Layout	5
More Information.....	13
Important Notice for Richtek Evaluation Board	13

Introduction

General Product Information

The RT5797A is a high efficiency synchronous step-down DC-DC converter. Its input voltage range is from 2.7V to 6V and provides an adjustable regulated output voltage from 0.6V to 3.4V while delivering up to 3A of output current. The internal synchronous low on-resistance power switches increase efficiency and eliminate the need for an external Schottky diode. The RT5797A is available in the WDFN-8SL 2x2 packages.

Product Feature

- Efficiency Up to 95%
- $R_{DS(ON)}$ 100m Ω HS / 70m Ω LS
- V_{IN} Range 2.7V to 6V
- V_{REF} 0.6V with $\pm 1\%$ Accuracy at 25°C
- CMCOT™ Control Loop Design for Best Transient Response, Robust Loop Stability with Low-ESR (MLCC) C_{OUT}
- Fixed Soft-Start 1.2ms
- Power Saving in Light Load

Key Performance Summary Table

Key Features	Evaluation Board Number : PCB103_V1
Default Input Voltage	5V
Max Output Current	3A
Default Output Voltage	1.2V
Default Marking & Package Type	RT5797AHGQWA, WDFN-8SL 2x2
Operation Frequency	1MHz in CCM mode

Bench Test Setup Conditions

Headers Description and Placement

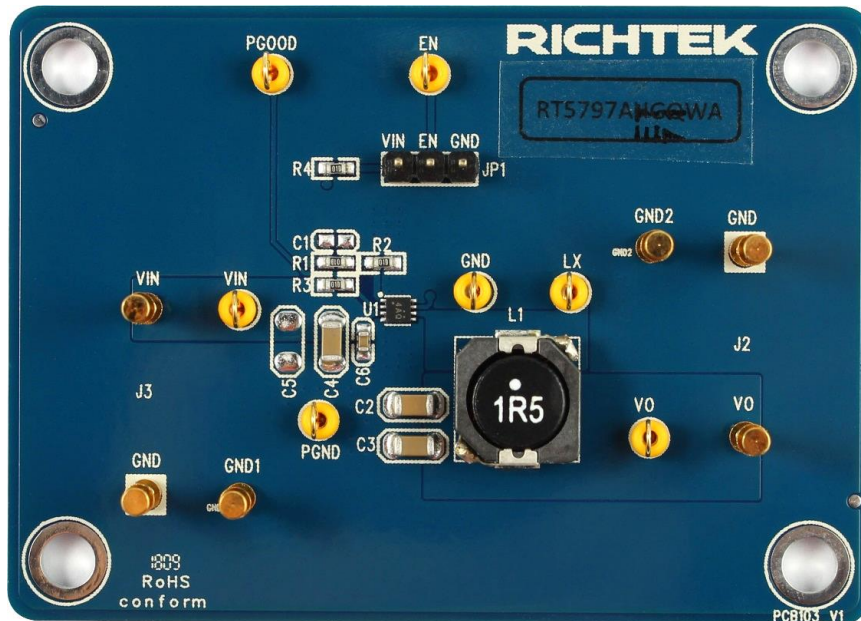

Carefully inspect all the components used in the EVB according to the following Bill of Materials table, and then make sure all the components are undamaged and correctly installed. If there is any missing or damaged component, which may occur during transportation, please contact our distributors or e-mail us at evb_service@richtek.com.

Test Points

The EVB is provided with the test points and pin names listed in the table below.

Test point/ Pin name	Signal	Comment (expected waveforms or voltage levels on test points)
FB	Feedback Voltage Input	An external resistor divider from the output to SGND, tapped to the FB pin, sets the output voltage. keep away from high current loops and swithing voltages.
PGOOD	Power Good Indicator	The output of this pin is an open-drain with external pull-up resistor. PG is pulled up when the FB voltage is within 90%, otherwise it is LOW.
VIN	Supply Voltage Input	The RT5797A operates from a 2.7V to 6V input.
PGND, GND GND1, GND2	Power Ground	Power ground. The exposed pad must be soldered to a large PCB and connected to PGND for maximum thermal dissipation.
NC	No Internal Connection	No internal connection.
LX	Switch Node	Switch node.
EN	Enable Control Input	Enable control input. A logic-high enables the converter; a logic-low forces the device into shutdown mode.
SGND	Signal Ground	Signal ground of the FB network. SGND should be connected to PGND close to the IC PGND pins.
VO	Output voltage	Output voltage.

Power-up & Measurement Procedure

1. Apply a 5V nominal input power supply ($2.7V < V_{IN} < 6V$) to the VIN and GND terminals.
2. Set the jumper at JP1 to connect terminals 2 and 3, connecting EN to VIN through resistor R4 (100kΩ). The Enable pin can be connected to VIN directly as well to enable operation.
3. Verify the output voltage (approximately 1.2V) between VOUT and GND.
4. Connect an external load up to 3A to the VOUT and GND terminals and verify the output voltage and current.

Output Voltage Setting

Set the output voltage with the resistive divider (R1, R2) between VOUT and GND with the midpoint connected to FB. The output is set by the following formula :

$$V_{OUT} = V_{FB} \times \left(1 + \frac{R1}{R2}\right)$$

The placement of the resistive divider should be within 5mm of the FB pin. The resistance of R2 is suggested between 10kΩ and 150kΩ to minimize power consumption, and noise pick-up at the FB pin. The resistance of R1 can then be obtained as below :

$$R1 = \frac{R2 \times (V_{OUT} - V_{FB})}{V_{FB}}$$

For better output voltage accuracy, divider resistors (R1 and R2) should have tolerance of ±1% tolerance or better.

Schematic, Bill of Materials & Board Layout

EVB Schematic Diagram

RT5797AHGQW demo board : V_{IN} 5V, V_{OUT} 1.2V / 3A

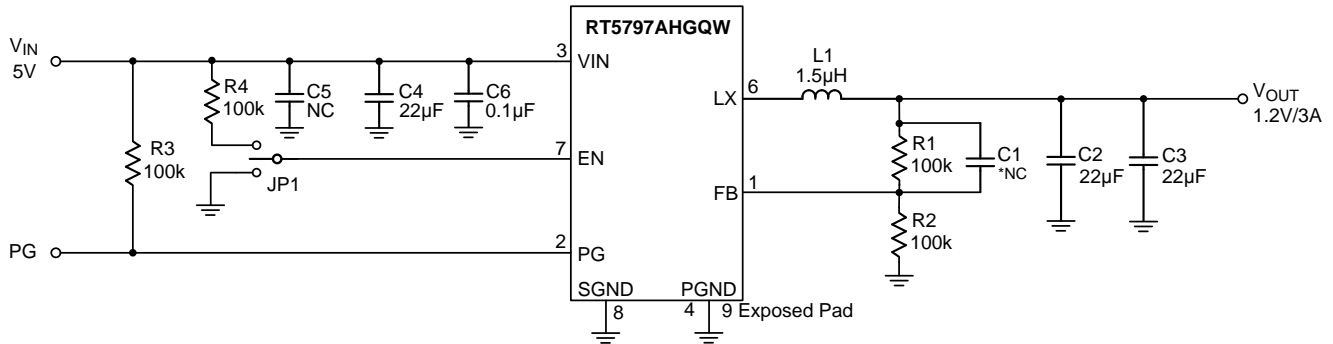

C2, C3, C4 : 22µF/16V/1206 Murata GRM31CR61C226KE15L
L1 : 1.5µH, 5.55mΩ, $I_{SAT} = 12.5A$, WURTH 7447714015
*C1 : Option for performance fine tune

Note:

1. Do not hot-plug a live 5V supply to the board; if hot-plugging is required, add ~100µF electrolytic capacitor at the input.

A small feedforward capacitor (C1) can be introduced into the feedback network to speed up the transient response of high output voltage circuits. Adding C1 can also improve the light load PSM switching behavior. The feedforward capacitor is added across the upper FB divider.

To optimize transient response, C1 value is chosen so that the gain and phase boost of the feedback network increases the bandwidth of the converter, while still maintaining an acceptable phase margin. Generally, larger C1 values provide higher bandwidth, but may result in an unacceptable phase margin or instability.

Measurement Results

<p>Output ripple measurement at $V_{IN} = 5V$ 10mA load Cyan : V-SW; Blue : V_{OUT}</p>	<p>Output ripple measurement at $V_{IN} = 5V$ 3A load Cyan : V-SW; Blue : V_{OUT}</p>
<p>Ch1 Pk-Pk 19.8mV Ch2 Freq 817.1kHz</p> <p>28 Sep 2016 09:29:56</p>	<p>Ch1 Pk-Pk 13.4mV Ch2 Freq 1.062MHz</p> <p>28 Sep 2016 09:29:23</p>
<p>Output ripple at 10mA load : 19.8mVpp, PSM mode</p>	<p>Output ripple at 3A load : 13.4mVpp PWM frequency is 1.062kHz.</p>

<p>Dynamic load 0.01A to 2.2A load step Blue : V_{OUT}; Green : load current step</p>	<p>Dynamic load 1A to 2.6A load step Blue : V_{OUT}; Green : load current step</p>
<p>Ch1 Max 21.0mV Ch1 Min -33.0mV Ch4 High 2.16 A Ch4 Low 20.0mA</p> <p>27 Sep 2016 15:57:29</p>	<p>Ch1 Max 22.0mV Ch1 Min -24.0mV Ch4 High 2.64 A Ch4 Low 1.00 A</p> <p>27 Sep 2016 15:59:24</p>
<p>Overshoot : 21mV, Undershoot : 33mV in light load mode</p>	<p>Overshoot : 22mV, Undershoot : 24mV</p>

<p>OCP measurement : Dynamic load close to OCP Blue: V_{OUT}; Purple: P_{good}; Green: I_{out}</p>	<p>OCP measurement : Full output short circuit Blue: V_{OUT}; Purple: P_{good}; Green: I_{out}</p>
<p>Vout drops at 4A peak load.</p>	<p>Frequency reduction, hiccup mode at 4.24A peak load current</p>

<p>Start-up measurement from Enable : EN pin 7 low – high Cyan : V-Enable; Blue:V_{OUT}; Purple : P_{good}; Green : I_{OUT}</p>	<p>Start-up measurement from VIN : Cyan : V_{IN}; Blue : V_{OUT}; Purple : P_{good}; Green : I_{OUT}</p>
<p>Start-up time 1.24msec. Soft-start 1.1msec</p>	<p>V_{IN} > 2.24V initiates start-up.</p>

Efficiency Measurements

RT5797AHGQW 5V - 1.2V efficiency application								
5V input	Vin	Iin	Vout	Iout	efficiency	Ploss	Ploss L	Ploss IC
5V-1.2V, 0.001A	4.997	0.0003	1.216	0.001	81.1%	0.000	0.000	0.000
5V-1.2V, 0.01A	4.997	0.0029	1.216	0.01	83.9%	0.002	0.000	0.002
5V-1.2V, 0.1A	4.991	0.0279	1.211	0.1	87.0%	0.018	0.000	0.018
5V-1.2V, 0.3A	4.977	0.0829	1.207	0.3	87.8%	0.050	0.001	0.050
5V-1.2V, 0.5A	4.969	0.1352	1.206	0.5	89.8%	0.069	0.005	0.064
5V-1.2V, 1A	4.992	0.2746	1.204	1	87.8%	0.167	0.014	0.153
5V-1.2V, 1.5A	4.931	0.4325	1.203	1.5	84.6%	0.328	0.025	0.303
5V-1.2V, 2A	4.957	0.5992	1.201	2	80.9%	0.568	0.041	0.527
5V-1.2V, 3A	4.98	0.9869	1.194	3	72.9%	1.333	0.087	1.246
5V-1.2V, 3A	4.974	1.0279	1.192	3	69.9%	1.537	0.087	1.450

T-IC

87C

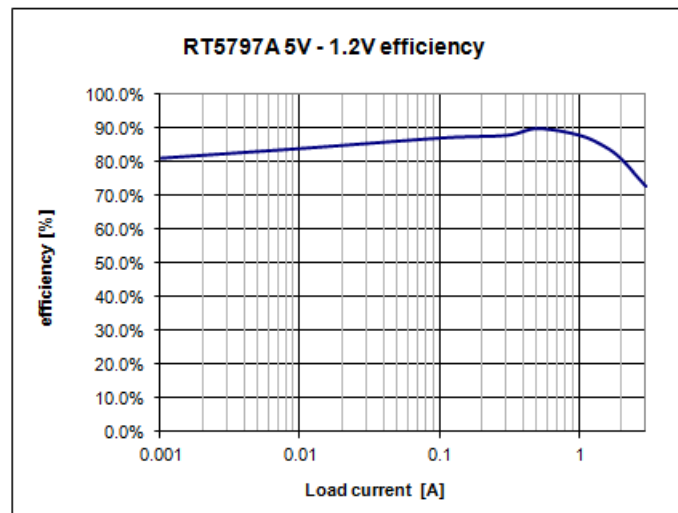
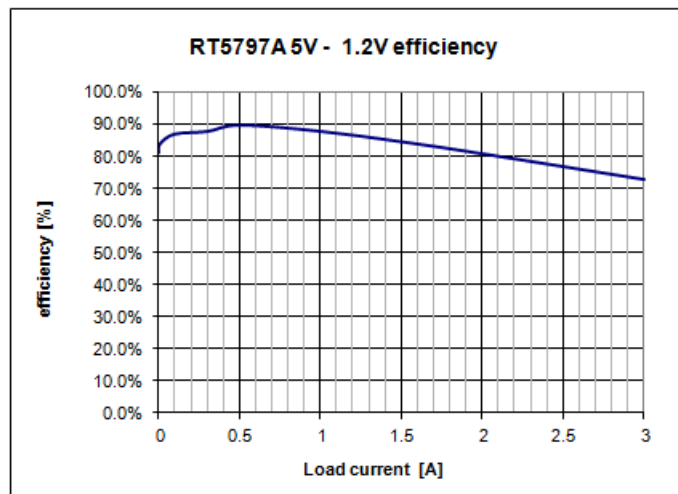

RT5797AHGQW 3.3V - 1.2V efficiency application								
3.3V input	Vin	Iin	Vout	Iout	efficiency	Ploss	Ploss L	Ploss IC
3.3V-1.2V, 0.001A	3.294	0.0005	1.215	0.001	73.8%	0.000	0.000	0.000
3.3V-1.2V, 0.01A	3.293	0.0042	1.214	0.01	87.8%	0.002	0.000	0.002
3.3V-1.2V, 0.1A	3.215	0.0422	1.213	0.1	89.4%	0.014	0.000	0.014
3.3V-1.2V, 0.3A	3.268	0.122	1.206	0.3	90.7%	0.037	0.001	0.036
3.3V-1.2V, 0.5A	3.255	0.2049	1.206	0.5	90.4%	0.064	0.005	0.059
3.3V-1.2V, 1A	3.275	0.4238	1.205	1	86.8%	0.183	0.014	0.169
3.3V-1.2V, 1.5A	3.287	0.6752	1.203	1.5	81.3%	0.415	0.025	0.389
3.3V-1.2V, 2A	3.267	0.9452	1.201	2	77.8%	0.686	0.041	0.645
3.3V-1.2V, 3A	3.286	1.5771	1.194	3	69.1%	1.600	0.087	1.513
3.3V-1.2V, 3A	3.287	1.6278	1.187	3	66.6%	1.790	0.087	1.703

T-IC

91.4C

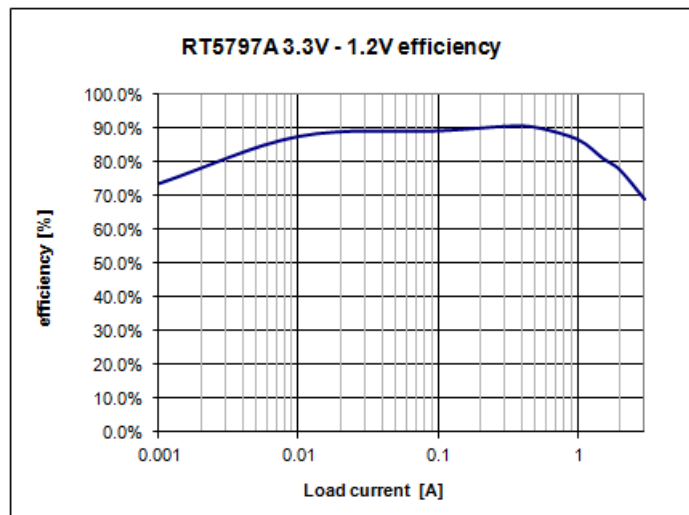
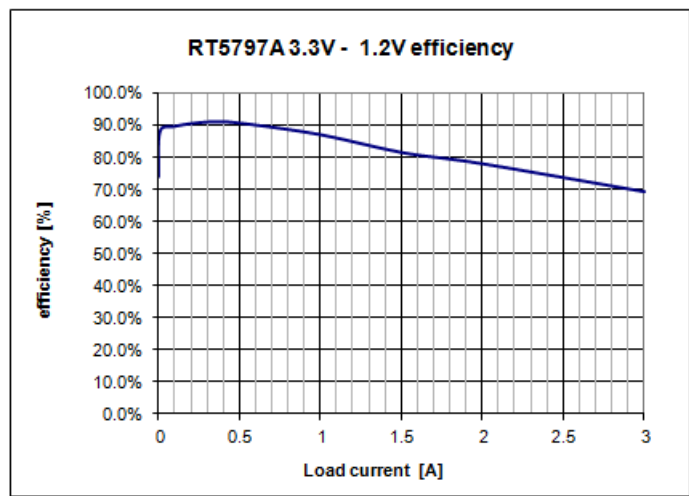

Bill of Materials

Reference	Qty	Part Number	Description	Package	Manufacturer
U1	1	RT5797AHGQWA	DC-DC Converter	WDFN-8SL 2x2	Richtek
C1	1		NC	C-0603	
C2, C3, C4	3	GRM31CR61C226KE15L	22 μ F/16V/X5R/1206	C-1206	muRata
C5	1		NC	C-1206	
C6	1	GRM188R71H104KA93D	100nF/50V/X7R/0603	C-0603	muRata
L1	1	7447714015	1.5 μ H	10x10x5mm	WURTH ELEKTRONIK
R1, R2, R3, R4	4	WR06X1003FTL	100k/0603	R-0603	WALSIN

PCB Layout

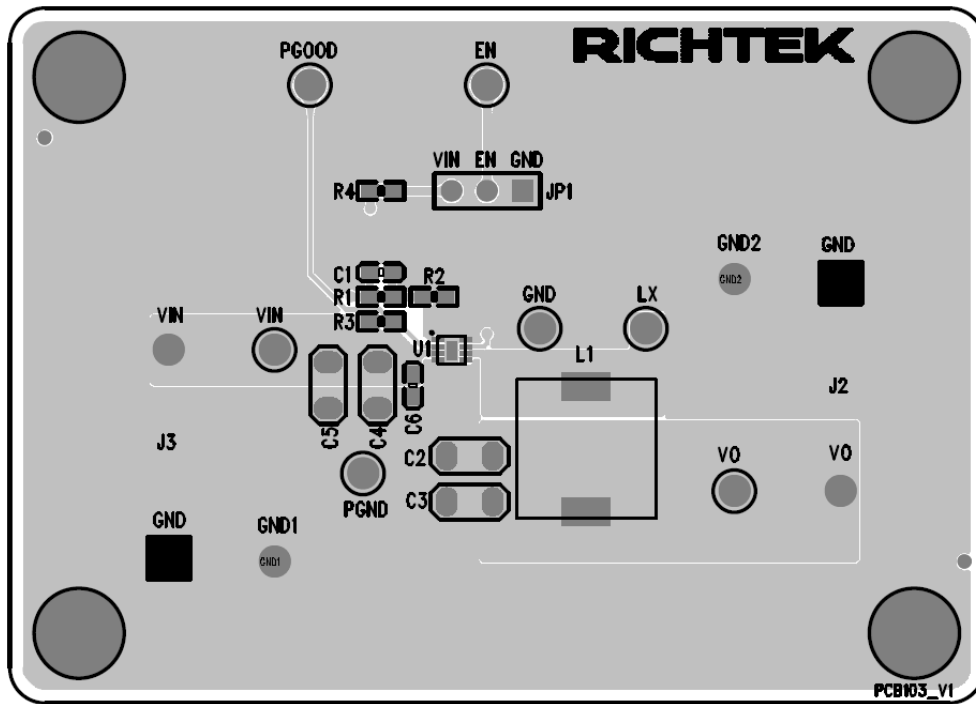

Top View (1st layer)

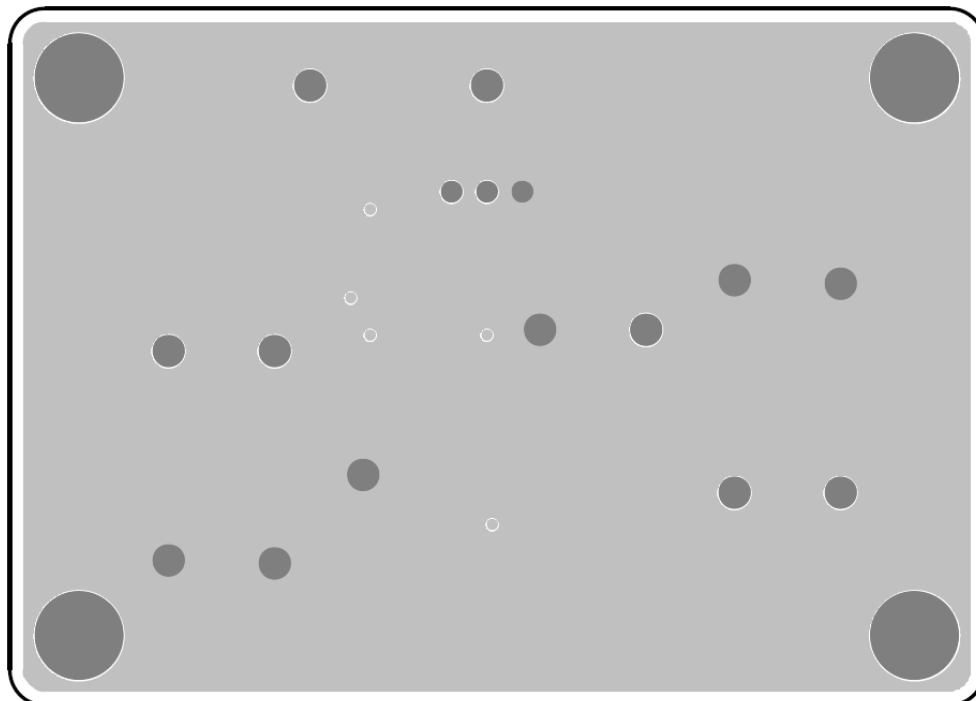

PCB Layout—Inner Side (2nd Layer)

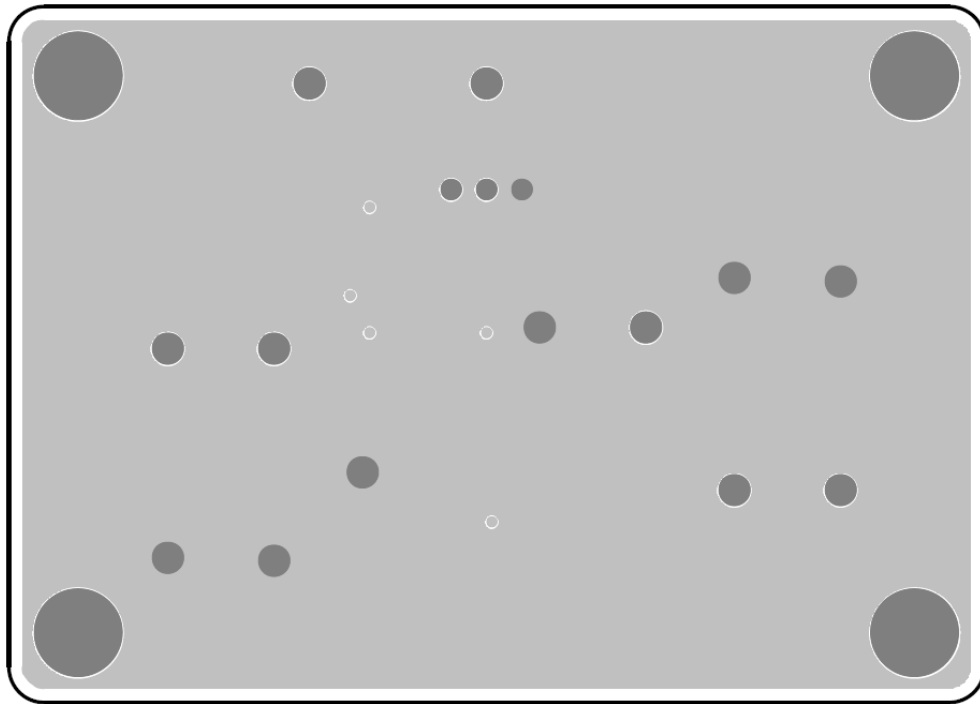

PCB Layout—Inner Side (3rd Layer)

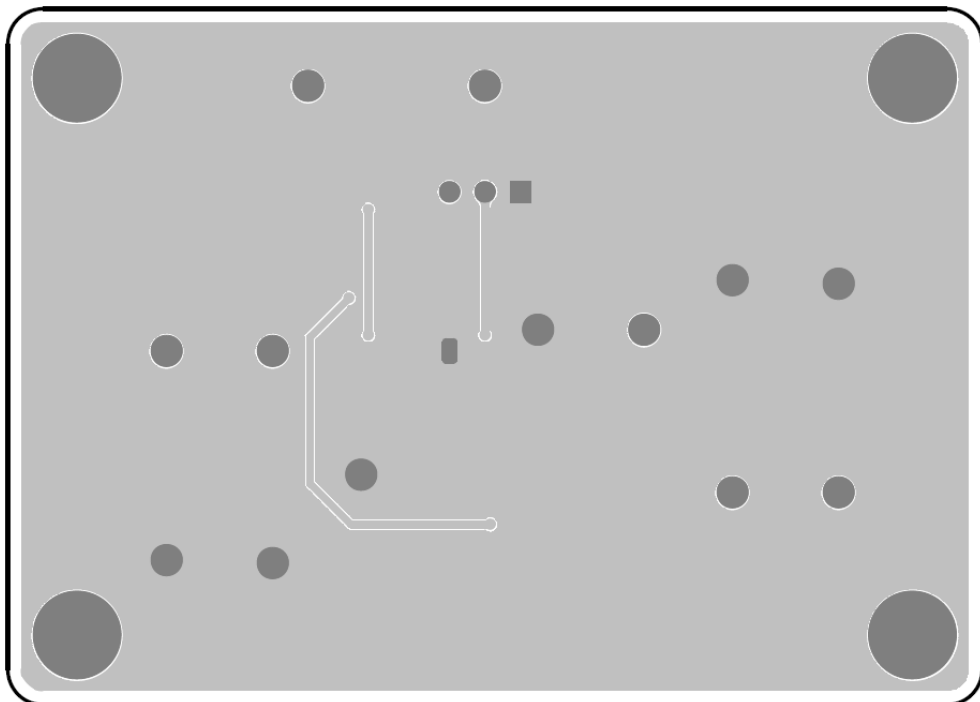

Bottom View (4th Layer)

More Information

For more information, please find the related datasheet or application notes from Richtek website <http://www.richtek.com>.

Important Notice for Richtek Evaluation Board

THIS DOCUMENT IS FOR REFERENCE ONLY, NOTHING CONTAINED IN THIS DOCUMENT SHALL BE CONSTRUED AS RICHTEK'S WARRANTY, EXPRESS OR IMPLIED, UNDER CONTRACT, TORT OR STATUTORY, WITH RESPECT TO THE PRESENTATION HEREIN. IN NO EVENT SHALL RICHTEK BE LIABLE TO BUYER OR USER FOR ANY AND ALL DAMAGES INCLUDING WITHOUT LIMITATION TO DIRECT, INDIRECT, SPECIAL, PUNITIVE OR CONSEQUENTIAL DAMAGES.

Mouser Electronics

Authorized Distributor

Click to View Pricing, Inventory, Delivery & Lifecycle Information:

[Richtek:](#)

[EVB_RT5797AHGQWA](#)