

SUPER FLUX LED LAMP, 4PIN LED

BL-FL7660xx

Features:

- 7.62*7.62*4.0MM, 3MM ROUND SUPER FLUX LED LAMP
- Ultra brightness.
- Wide Viewing Angles.
- Ideal For Backlight and Indicator
- RoHs Compliance



□ Electrical-optical characteristics: (Ta=25°C) (Test Condition: IF=20mA)

Part Number	Chip			Lens Type	Forward Voltage(VF) Unit:V		Luminous Intensity (lv) Unit:mcd		Viewing Angle 2θ/2 (deg)
	Emitted Color	Material	λ _P (nm)		Typ	Max	Min.	Typ.	
					BL-FL7660URC	Ultra Red	AlGaAs,DDH	660	
BL-FL7660UEC	Ultra Orange	AlGaInP	630	2.10	2.50	800	1500		
BL-FL7660UYC	Ultra Yellow	AlGaInP	590	2.10	2.50	600	1300		
BL-FL7660UGC	Ultra Green	AlGaInP	574	2.20	2.50	200	700		
BL-FL7660PGC	Ultra Pure Green	InGaN	525	3.80	4.50	1000	5000		
BL-FL7660BGC	Ultra Bluish Green	InGaN	505	3.80	4.50	800	4000		
BL-FL7660UBC	Ultra Blue	InGaN	470	3.00	4.20	800	2000		
BL-FL7660UVC	UV	InGaN	405	3.00	4.20	180	220		
BL-FL7660UWC	Ultra White	InGaN	/	3.00	4.20	1000	5000		

□ Absolute maximum ratings (Ta=25°C)

Parameter	UR	UE	UY	UG	PG	BG	UB	W	Unit
Forward Current I _F	25	30	30	30	30	30	30	30	mA
Power Dissipation P _d	60	65	65	75	110	110	120	120	mW
Reverse Voltage V _R	5	5	5	5	5	5	5	5	V
Peak Forward Current I _{PF} (Duty 1/10 @1KHZ)	150	150	150	150	150	100	100	100	mA
Operation Temperature T _{OPR}	-40 to +80								°C
Storage Temperature T _{STG}	-40 to +85								°C
Lead Soldering Temperature T _{SOL}	Max.260±5°C for 3 sec Max. (1.6mm from the base of the epoxy bulb)								°C

SUPER FLUX LED LAMP, 4PIN LED

BL-FL7660xx

□ **Package configuration & Internal circuit diagram**

BL-LF7660 Series

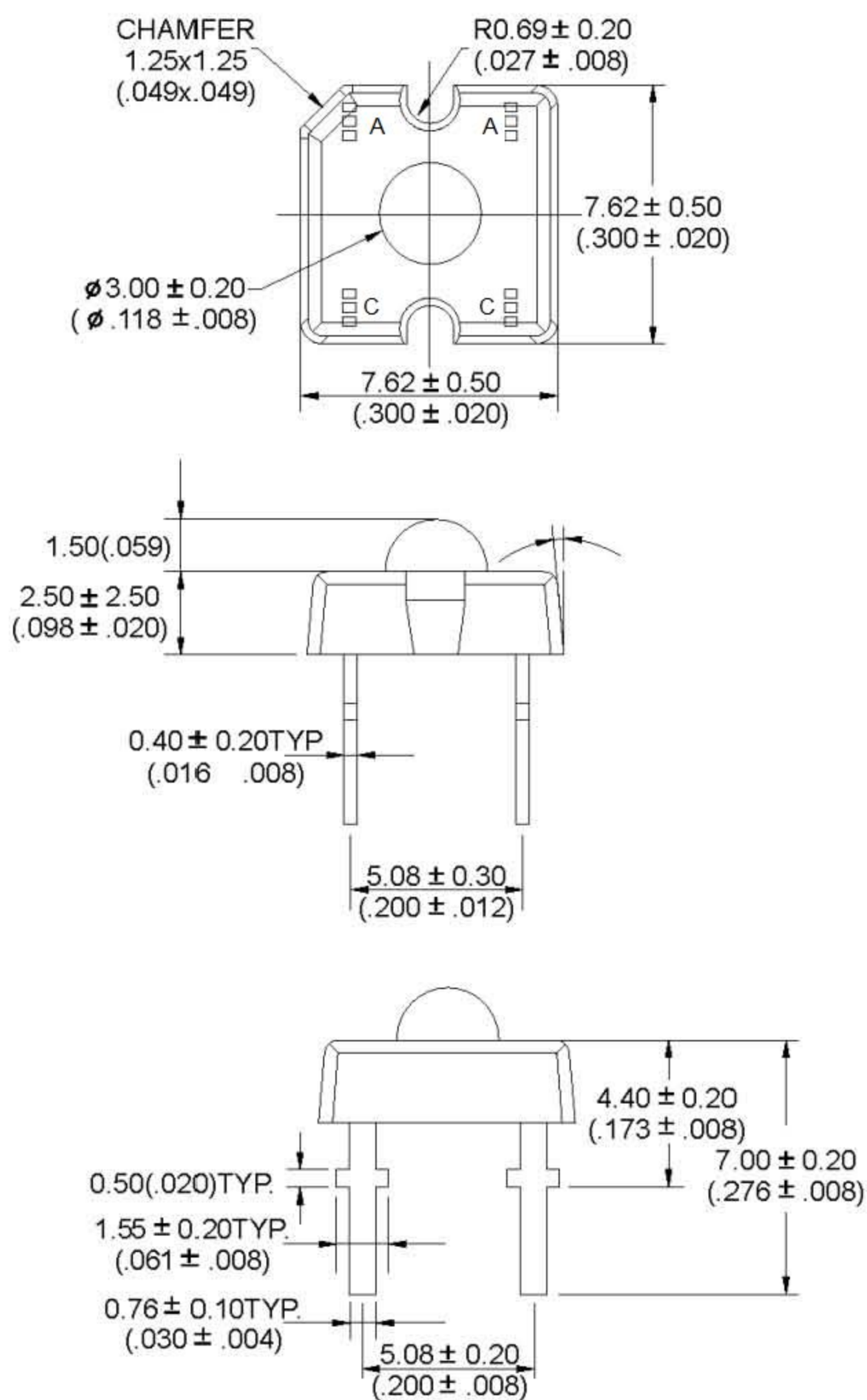

Notes:

1. All dimensions are in millimeters (inches)
2. Tolerance is ±0.25(0.01") unless otherwise noted.
3. Specifications are subject to change without notice.

SUPER FLUX LED LAMP, 4PIN LED

BL-FL7660xx

□ Typical electrical-optical characteristics curves:

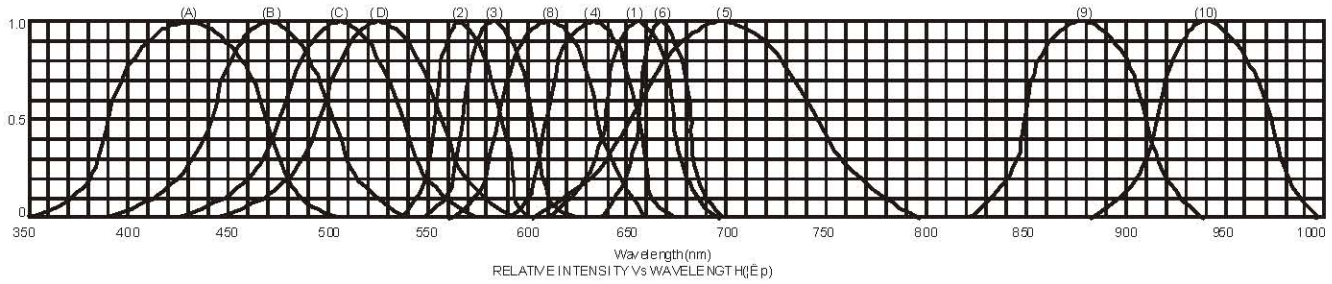

- (1) - GaAsP/GaAs 655nm/Red
- (2) - GaP 570nm/Yellow Green
- (3) - GaAsP/GaP 585nm/Yellow
- (4) - GaAsP/GaP 635nm/Orange & Hi-Eff Red
- (5) - GaP 700nm/Bright Red
- (6) - GaAlAs/GaAs 660nm/Super Red
- (8) - GaAsP/GaP 610nm/Super Red
- (9) - GaAlAs 880nm
- (10) - GaAs/GaAs & GaAlAs/GaAs 940nm
- (A) - GaN/SiC 430nm/Blue
- (B) - InGaN/SiC 470nm/Blue
- (C) - InGaN/SiC 505nm/Ultra Green
- (D) - InGaAlSiC 525nm/Ultra Green

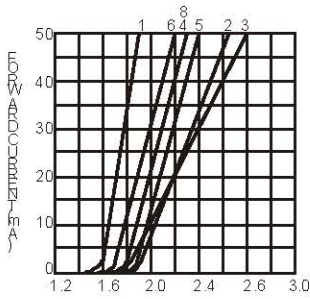

FORWARD VOLTAGE (Vf)
FORWARD CURRENT VS.
FORWARD VOLTAGE

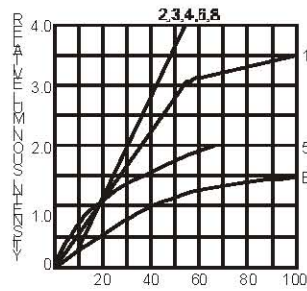

FORWARD CURRENT (mA)
RELATIVE LUMINOUS
INTENSITY VS. FORWARD
CURRENT

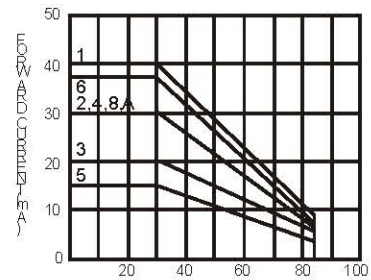

AMBIENT TEMPERATURE Ta(°C)
FORWARD CURRENT VS. AMBIENT
TEMPERATURE

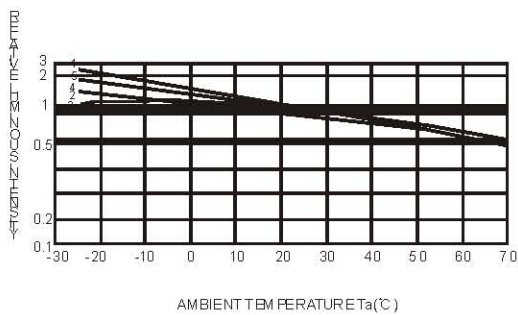

AMBIENT TEMPERATURE Ta(°C)

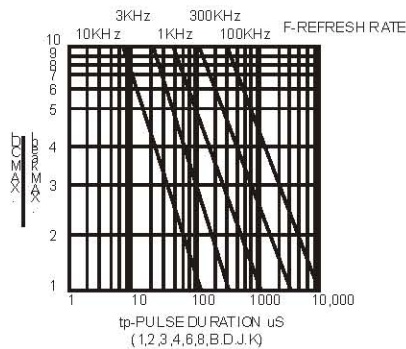

tp-PULSE DURATION µs
(1,2,3,4,6,8,B,D,J,K)

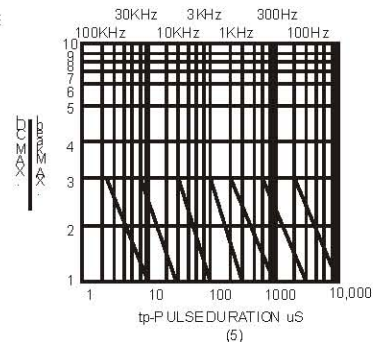

(5)

NOTE: 25°C free air temperature unless otherwise specified

SUPER FLUX LED LAMP, 4PIN LED

BL-FL7660xx

□ Packing and weighting

