



## Transient Voltage Suppressor

**Breakdown Voltage 5.0 to 170 Volts**  
**Peak Pulse Power 600 Watts**

### Features

- Breakdown Voltages ( $V_{BR}$ ) from 5.0 to 170V
- 600W peak pulse power capability with a 10/1000 $\mu$ s waveform, repetitive rate (duty cycle):0.01%
- Fast Response Time
- Low incremental surge resistance
- Excellent clamping capability
- Available in uni-directional and bi-directional
- High temperature soldering guaranteed: 265 $^{\circ}$ C /10 seconds, 0.375" (9.5mm) lead length, 5lbs. (2.3kg) tension

### Application

- Use in sensitive electronics protection against voltage transients induced by inductive load switching and lighting on ICs, MOSFE, signal lines of sensor units for consumer, computer, industrial, automotive and telecommunication

### Mechanical Data

- **Case:** Void-free transfer molded thermosetting epoxy body meeting UL94V-O
- **Terminals:** Tin-Lead or ROHS Compliant annealed matte-Tin plating readily solderable per MIL-STD-750, Method 2026
- **Marking:** Body marked with part number
- **Polarity:** Cathode indicated by band. No marking on bi-directional devices
- **Weight:** 0.093g ( Approximately )

#### CASE: SMB (DO214AA)

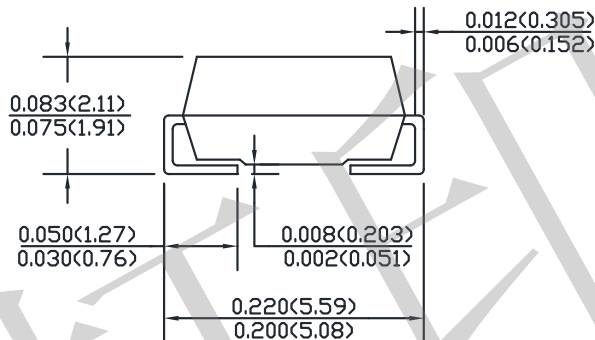
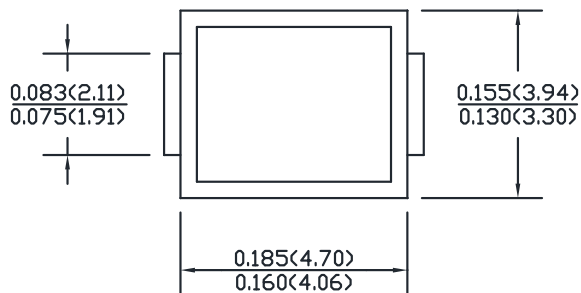

Dimensions in inches and (millimeters)

### Maximum Ratings and Electrical Characteristics @ 25 $^{\circ}$ C unless otherwise specified

Symbol	Conditions	Value	Unit
$P_{PPM}$	Peak pulse power capability with a 10/1000 $\mu$ s	600	W
$I_{PPM}$	Peak pulse current with a 10/1000 $\mu$ s	SEE TABLE1	A
$P_{M(AV)}$	Steady state power dissipation at $T_L=25^{\circ}$ C ,Lead lengths 0.375"(10mm)	5.0	W
	Steady state power dissipation at $T_A=25^{\circ}$ C when mounted on FR4 PC described for thermal resistance	1.38	W
$I_{FSM}$	Peak forward surge current,8.3ms single half sine-wave unidirectional only(1)	100	A
$V_F$	Maximum instantaneous forward voltage at 30A for unidirectional only	3.5	V
$R_{\theta JL}$	Thermal resistance junction to lead	25	$^{\circ}$ C/W
$R_{\theta JA}$	Thermal resistance junction to ambient	90	$^{\circ}$ C/W
$T_J, T_{STG}$	Operating and Storage Temperature	-65 to +150	$^{\circ}$ C

#### Notes:

(1) Measured on 8.3ms single half sine-wave or equivalent square wave, duty cycle=4 pulses per minute maximum

**Electrical Characteristics @ 25°C (Unless Otherwise Noted) TABLE1**

Microsemi Part Number	Breakdown Voltage $V_{BR} @ I_{BR}$			Reverse Stand Off Voltage	Maximum Standby current $I_D @ V_{WM}$	Maximum Peak Pulse Current	Maximum Clamping Voltage $V_C @ I_{PP}$
	MIN	MAX					
	$V_{BR}(V)$		$I_{BR}(mA)$				
SMBJ5.0	6.40	7.30	10	5.0	800	62.5	9.6
SMBJ5.0A	6.40	7.00	10	5.0	800	65.2	9.2
SMBJ6.0	6.67	8.15	10	6.0	800	52.6	11.4
SMBJ6.0A	6.67	7.37	10	6.0	800	58.3	10.3
SMBJ6.5	7.22	8.82	10	6.5	500	48.7	12.3
SMBJ6.5A	7.22	7.98	10	6.5	500	53.6	11.2
SMBJ7.0	7.78	9.51	10	7.0	200	45.1	13.3
SMBJ7.0A	7.78	8.60	10	7.0	200	50.0	12.0
SMBJ7.5	8.33	10.2	1	7.5	100	42.0	14.3
SMBJ7.5A	8.33	9.21	1	7.5	100	46.5	12.9
SMBJ8.0	8.89	10.9	1	8.0	50	40.0	15.0
SMBJ8.0A	8.89	9.83	1	8.0	50	44.1	13.6
SMBJ8.5	9.44	11.5	1	8.5	10	37.7	15.9
SMBJ8.5A	9.44	10.4	1	8.5	10	41.7	14.4
SMBJ9.0	10.0	12.2	1	9.0	5	35.5	16.9
SMBJ9.0A	10.0	11.1	1	9.0	5	39.0	15.4
SMBJ10	11.1	13.6	1	10.0	5	31.9	18.8
SMBJ10A	11.1	12.3	1	10.0	5	35.3	17.0
SMBJ11	12.2	14.9	1	11.0	5	29.9	20.1
SMBJ11A	12.2	13.5	1	11.0	5	33.0	18.2
SMBJ12	13.3	16.3	1	12.0	5	27.3	22.0
SMBJ12A	13.3	14.7	1	12.0	5	30.2	19.9
SMBJ13	14.4	17.6	1	13.0	1	25.2	23.8
SMBJ13A	14.4	15.9	1	13.0	1	27.9	21.5
SMBJ14	15.6	19.1	1	14.0	1	23.3	25.8
SMBJ14A	15.6	17.2	1	14.0	1	25.8	23.2
SMBJ15	16.7	20.4	1	15.0	1	22.3	26.9
SMBJ15A	16.7	18.5	1	15.0	1	24.0	24.4
SMBJ16	17.8	21.8	1	16.0	1	20.8	28.8
SMBJ16A	17.8	19.7	1	16.0	1	23.1	26.0
SMBJ17	18.9	23.1	1	17.0	1	19.7	30.5
SMBJ17A	18.9	20.9	1	17.0	1	21.7	27.6
SMBJ18	20.0	24.4	1	18.0	1	18.6	32.2
SMBJ18A	20.0	22.1	1	18.0	1	20.5	29.2
SMBJ20	22.2	27.1	1	20.0	1	16.7	35.8
SMBJ20A	22.2	24.5	1	20.0	1	18.5	32.4
SMBJ22	24.4	29.8	1	22.0	1	15.2	39.4
SMBJ22A	24.4	26.9	1	22.0	1	16.9	35.5
SMBJ24	26.7	32.6	1	24.0	1	14.0	43.0
SMBJ24A	26.7	29.5	1	24.0	1	15.4	38.9
SMBJ26	28.9	35.3	1	26.0	1	12.4	46.6
SMBJ26A	28.9	31.9	1	26.0	1	14.2	42.1
SMBJ28	31.1	38.0	1	28.0	1	12.0	50.0
SMBJ28A	31.1	34.4	1	28.0	1	13.2	45.4
SMBJ30	33.3	40.7	1	30.0	1	11.2	53.5
SMBJ30A	33.3	36.8	1	30.0	1	12.4	48.4
SMBJ33	36.7	44.9	1	33.0	1	10.2	59.0
SMBJ33A	36.7	40.6	1	33.0	1	11.3	53.3
SMBJ36	40.0	48.9	1	36.0	1	9.3	64.3
SMBJ36A	40.0	44.2	1	36.0	1	10.3	58.1
SMBJ40	44.4	54.3	1	40.0	1	8.4	71.4
SMBJ40A	44.4	49.1	1	40.0	1	9.3	64.5

**Electrical Characteristics @ 25°C (Unless Otherwise Noted) TABLE1**

Microsemi Part Number	Breakdown Voltage $V_{BR}$ @ $I_{BR}$			Reverse Stand Off Voltage	Maximum Standby current $I_D$ @ $V_{WM}$	Maximum Peak Pulse Current	Maximum Clamping Voltage $V_C$ @ $I_{PP}$
	MIN	MAX					
	$V_{BR}(V)$		$I_{BR}(mA)$				
SMBJ43	47.8	58.4	1	43.0	1	7.8	76.7
SMBJ43A	47.8	52.8	1	43.0	1	8.6	69.4
SMBJ45	50.0	61.1	1	45.0	1	7.5	80.3
SMBJ45A	50.0	55.3	1	45.0	1	8.3	72.7
SMBJ48	53.3	65.1	1	48.0	1	7.0	85.5
SMBJ48A	53.3	58.9	1	48.0	1	7.7	77.4
SMBJ51	56.7	69.3	1	51.0	1	6.6	91.1
SMBJ51A	56.7	62.7	1	51.0	1	7.3	82.4
SMBJ54	60.0	73.3	1	54.0	1	6.2	96.3
SMBJ54A	60.0	66.3	1	54.0	1	6.9	87.1
SMBJ58	64.4	78.7	1	58.0	1	5.8	103.0
SMBJ58A	64.4	71.2	1	58.0	1	6.4	93.6
SMBJ60	66.7	81.5	1	60.0	1	5.6	107.0
SMBJ60A	66.7	73.7	1	60.0	1	6.2	96.8
SMBJ64	71.1	86.9	1	64.0	1	5.3	114.0
SMBJ64A	71.1	78.6	1	64.0	1	5.8	103.0
SMBJ70	77.8	95.1	1	70.0	1	4.8	125.0
SMBJ70A	77.8	86.0	1	70.0	1	5.3	113.0
SMBJ75	83.3	102.0	1	75.0	1	4.5	134.0
SMBJ75A	83.3	92.1	1	75.0	1	4.9	121.0
SMBJ78	86.7	106.0	1	78.0	1	4.3	139.0
SMBJ78A	86.7	95.8	1	78.0	1	4.7	126.0
SMBJ85	94.4	115.0	1	85.0	1	3.9	151.0
SMBJ85A	94.4	104.0	1	85.0	1	4.4	137.0
SMBJ90	100.0	122.0	1	90.0	1	3.8	160.0
SMBJ90A	100.0	111.0	1	90.0	1	4.1	146.0
SMBJ100	111.0	136.0	1	100.0	1	3.4	179.0
SMBJ100A	111.0	123.0	1	100.0	1	3.7	162.0
SMBJ110	122.0	149.0	1	110.0	1	3.0	196.0
SMBJ110A	122.0	135.0	1	110.0	1	3.4	177.0
SMBJ120	133.0	163.0	1	120.0	1	2.8	214.0
SMBJ120A	133.0	147.0	1	120.0	1	3.1	193.0
SMBJ130	144.0	176.0	1	130.0	1	2.6	231.0
SMBJ130A	144.0	159.0	1	130.0	1	2.9	209.0
SMBJ150	167.0	204.0	1	150.0	1	2.2	268.0
SMBJ150A	167.0	185.0	1	150.0	1	2.5	243.0
SMBJ160	178.0	218.0	1	160.0	1	2.1	287.0
SMBJ160A	178.0	197.0	1	160.0	1	2.3	259.0
SMBJ170	189.0	231.0	1	170.0	1	2.0	304.0
SMBJ170A	189.0	209.0	1	170.0	1	2.2	275.0

1. For bi-directional construction, indicate a C or CA suffix after part number, i.e. SMBJ170C or SMBJ170CA

## Characteristic Curve

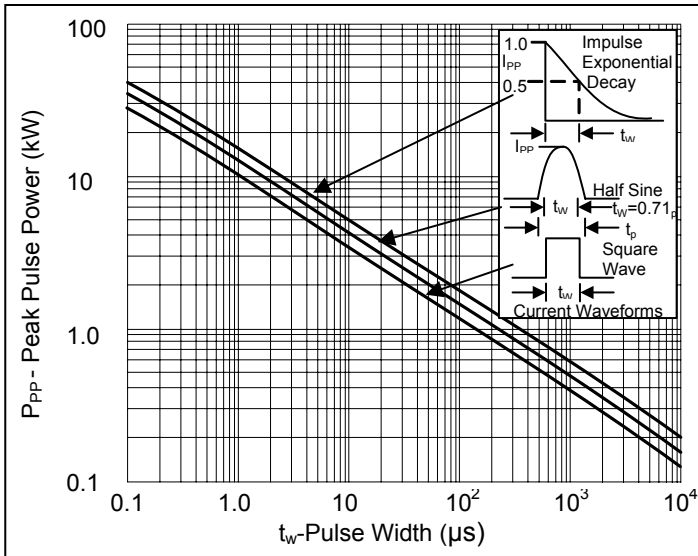

**Fig. 1 Peak Pulse Power vs. Pulse Time**

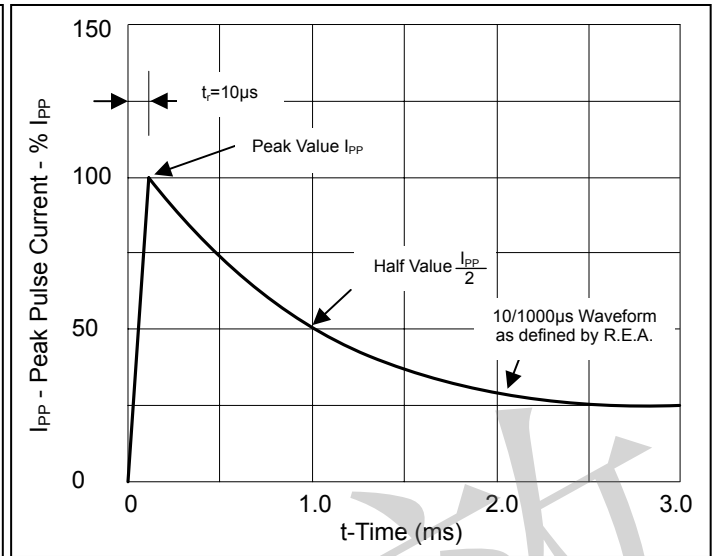

**Fig. 2 Pulse Waveform for Exponential Surge**

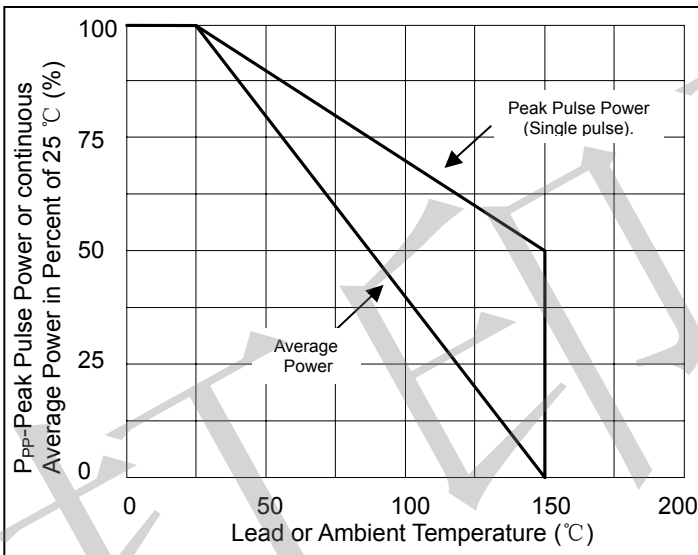

**Fig. 3 Derating Curve**

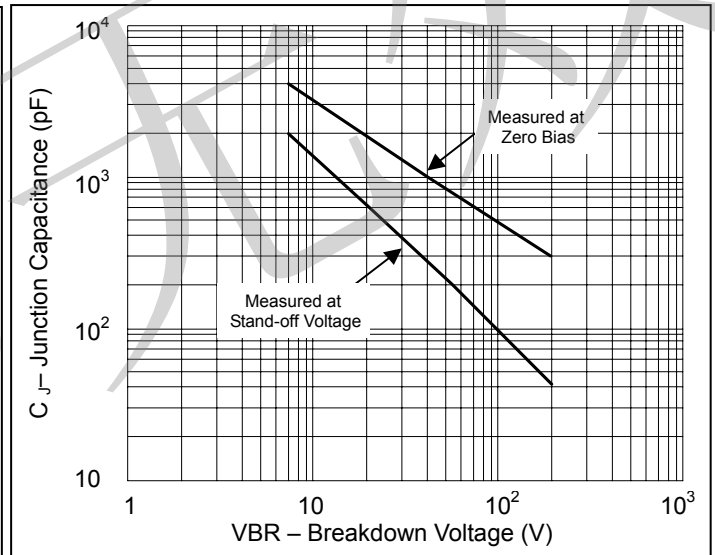

**Fig. 4 Typical Capacitance vs. Breakdown Voltage (Unipolar)**

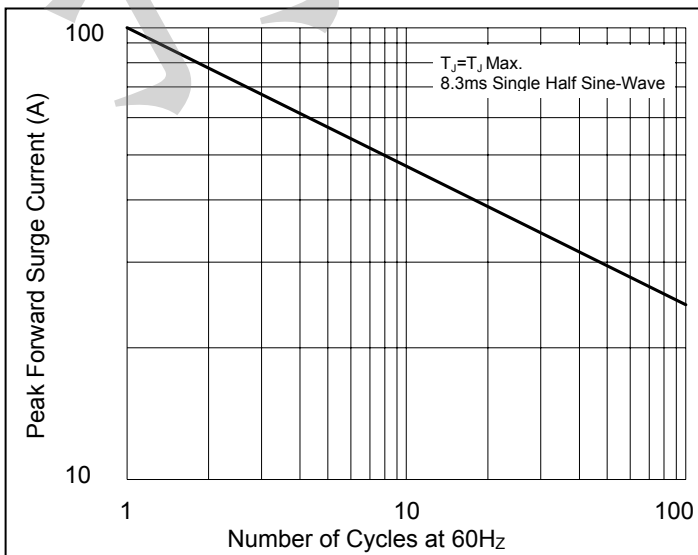

**Fig. 5 Max. Non-Repetitive Forward Surge Current Uni-Directional Only**