

**HIGH SENSITIVITY HALL EFFECT LATCH**

**Description**

The AH3761 is an integrated Hall effect latched sensor designed for electronic commutation of brush-less DC motor applications. The device includes an on-chip Hall voltage generator for magnetic sensing, a comparator that amplifies the Hall voltage, and a Schmitt trigger to provide switching hysteresis for noise rejection, and open drain output. An internal bandgap regulator is used to provide temperature compensated supply voltage for internal circuits and allows a wide operating supply range.

If a magnetic flux density larger than threshold Bop, DO is turned on (low). The output state is held until a magnetic flux density reversal falls below Brp causing DO to be turned off (high).

**Features**

- 3V to 28V DC Operation Voltage
- Chopper Stabilized
- Wide Operating Voltage Range
- Built-in Power Reverse Protection
- Built-in Voltage Overshoot Protection
- Output Short Circuit Protection
- Open Drain Pre-Driver
- SIP-3 (Ammo Pack), SIP-3 (Bulk Pack) and SC59 (Commonly known as SOT23 in Asia)
- Available in "Green" Molding Compound (No Br, Sb)
- **Totally Lead-Free & Fully RoHS Compliant (Note 1 & 2)**
- **Halogen and Antimony Free. "Green" Device (Note 3)**

Notes: 1. No purposely added lead. Fully EU Directive 2002/95/EC (RoHS), 2011/65/EU (RoHS 2) & 2015/863/EU (RoHS 3) compliant.  
2. See <https://www.diodes.com/quality/lead-free/> for more information about Diodes Incorporated's definitions of Halogen- and Antimony-free, "Green" and Lead-free.  
3. Halogen- and Antimony-free "Green" products are defined as those which contain <900ppm bromine, <900ppm chlorine (<1500ppm total Br + Cl) and <1000ppm antimony compounds.

**Pin Assignments**

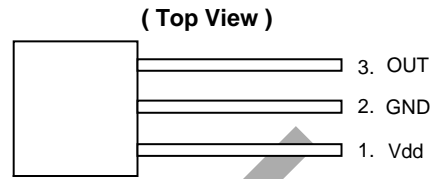

SIP-3 (Bulk Pack)

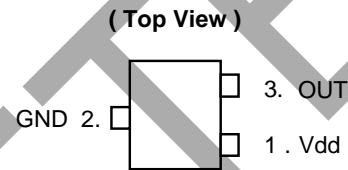

SC59

**Applications**

- Brushless DC Motor Commutation
- RPM Detection
- Consumer and Industrial Position Sensor
- Flow Meters

**Typical Applications Circuit**

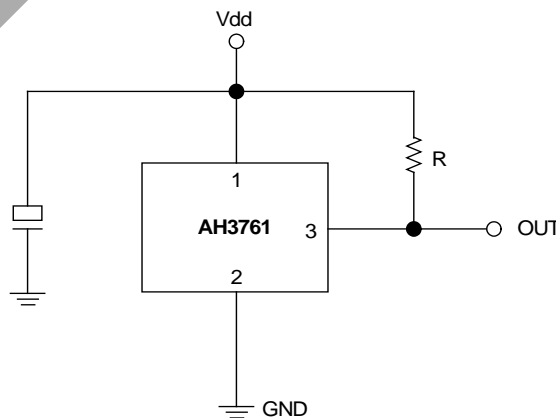

OBSOLETE - PART DISCONTINUED

**Pin Descriptions**

Pin Name	P/I/O	Pin #	Description
Vdd	P	1	Positive Power Supply
GND	P	2	Ground
OUT	O	3	Output Pin

**Functional Block Diagram**

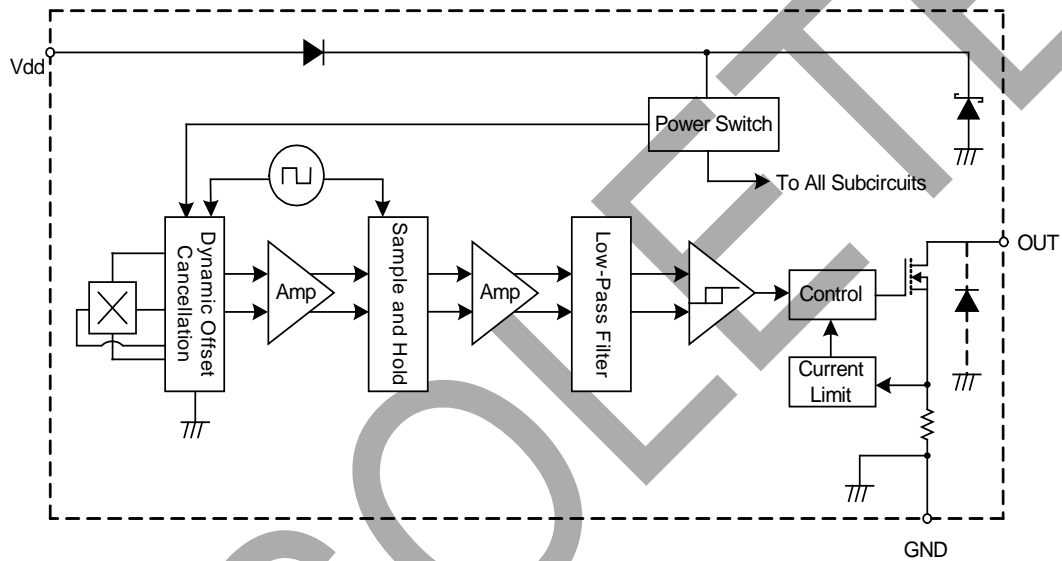

**Absolute Maximum Ratings** ( $T_A = +25^\circ\text{C}$ )

Symbol	Characteristics	Values	Unit	
$V_{DD}$	Supply Voltage	30	V	
$V_{RDD}$	Reverse Battery Voltage	-30	V	
B	Magnetic Flux Density	Unlimited		
$V_{DS}$	Output OFF Voltage	30	V	
$I_{O(peak)}$	Output "On" Current (Peak)	100	mA	
$T_{ST}$	Storage Temperature Range	-65 to +150	$^\circ\text{C}$	
$T_{J(MAX)}$	Maximum Junction Temperature	+150	$^\circ\text{C}$	
$P_D$	Package Power Dissipation	SIP-3 (Ammo Pack), SIP-3 (Bulk Pack)	550	mW
		SC59	230	mW
$\theta_{JC}$	Thermal Resistance Junction to case	SIP-3 (Ammo Pack), SIP-3 (Bulk Pack)	227	$^\circ\text{C/W}$
		SC59	543	$^\circ\text{C/W}$

OBSOLETE - PART DISCONTINUED

### Recommended Operating Conditions

Symbol	Characteristic	Conditions	Min	Typ.	Max	Unit
V <sub>DD</sub>	Supply Voltage	Operating	3	24	28	V
T <sub>A</sub>	Operating Ambient Temperature	Operating	-40	-	+125	°C

### Electrical Characteristics (T<sub>A</sub> = +25°C, V<sub>DD</sub> =24V, Note 4)

Symbol	Characteristic	Test Conditions	Min	Typ.	Max	Unit
V <sub>O(SAT)</sub>	Output Saturation Voltage	I <sub>out</sub> =20mA, B>Bop	-	300	500	mV
I <sub>OFF</sub>	Output Leakage Current	V <sub>O</sub> =24V, B<Bop	-	< 0.1	10	μA
I <sub>DD</sub>	Supply Current	Output Open	-	4	6	mA
t <sub>R</sub>	Output Rising Time	R <sub>L</sub> =10kΩ, C <sub>L</sub> =16pF	-	340	-	ns
t <sub>F</sub>	Output Falling Time	R <sub>L</sub> =10kΩ, C <sub>L</sub> =16pF	-	20	-	ns
f <sub>C</sub>	Chopping Frequency	-	-	300	-	kHz
I <sub>OM</sub>	Output Current Limit	B>Bop (Note 5)	50	70	90	mA
t <sub>ST</sub>	Start-up time of IC	V <sub>DD</sub> >3V, B>Bop (Note 6)	-	47	-	μs

- Notes:
- Typical data is at T<sub>A</sub>=+25°C, V<sub>DD</sub>=24V and is design information only.
  - The device will shut down operating after the output current I<sub>O</sub> is over the output current limit I<sub>OM</sub> for 160μs (typically). The device will re-start up operating after resetting the supply voltage V<sub>DD</sub>.
  - I<sub>n</sub> initial power on time, the output state is kept in "High" in this start-up time of IC.

### Magnetic Characteristics (T<sub>A</sub> = +25°C, V<sub>DD</sub> =3V to 28V, Note 7)

(1mT=10Gauss)

Symbol	Parameter	Min	Typ.	Max	Unit
B <sub>op</sub>	Operate Point	5	30	60	Gauss
B <sub>rp</sub>	Release Point	-60	-30	-5	Gauss
B <sub>hys</sub>	Hysteresis	-	60	-	Gauss

- Notes: 7. Magnetic characteristics are for design information, which will vary with supply voltage, operating temperature and after soldering.

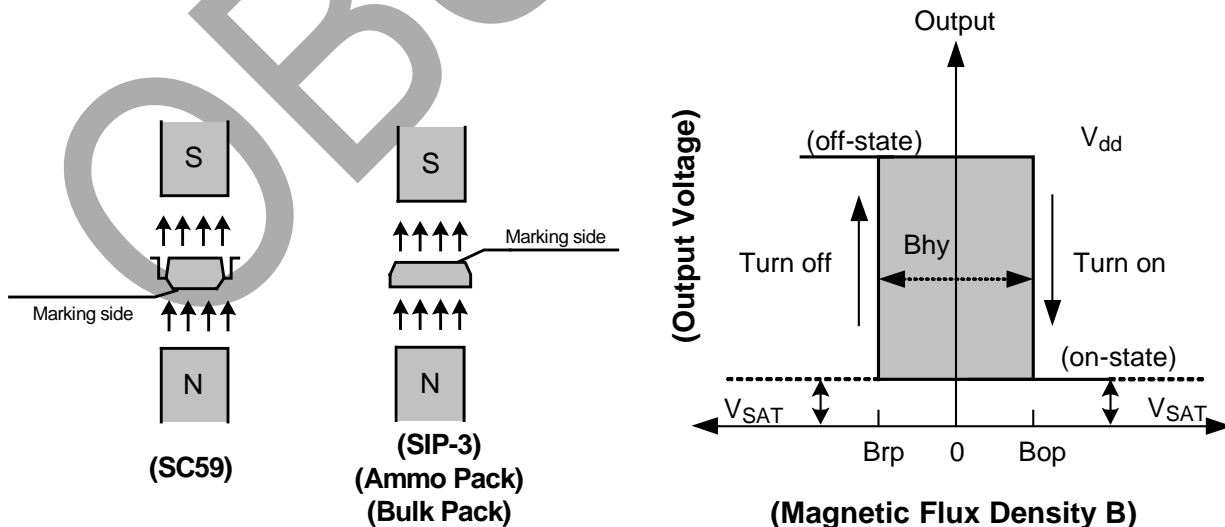

**Performance Characteristics**

(1) SIP-3 (Ammo Pack), SIP-3 (Bulk Pack)

T <sub>A</sub> (°C)	25	50	60	70	80	85	90	95	100
P <sub>D</sub> (mW)	550	440	396	352	308	286	264	242	220
T <sub>A</sub> (°C)	105	110	115	120	125	130	135	140	150
P <sub>D</sub> (mW)	198	176	154	132	110	88	66	44	0

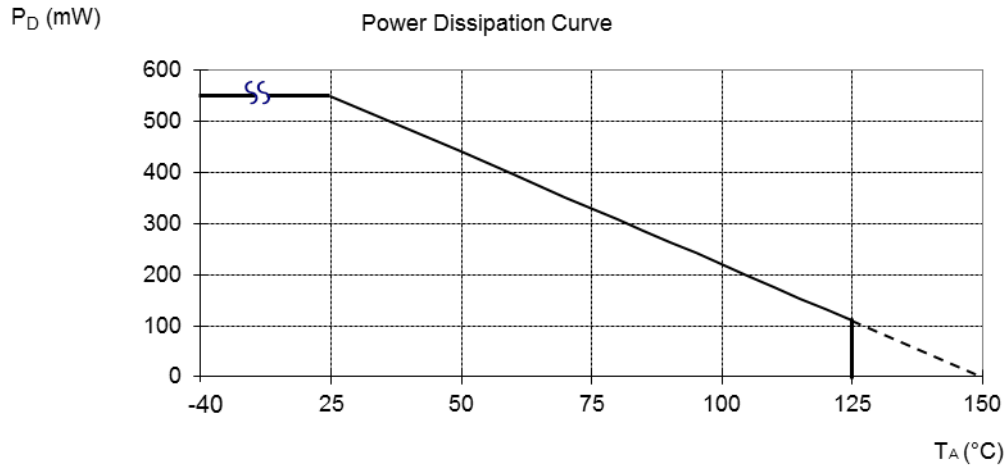

(2) SC59 (Commonly known as SOT23 in Asia)

T <sub>A</sub> (°C)	25	50	60	70	80	90	100	110	120	125	130	140	150
P <sub>D</sub> (mW)	230	184	166	147	129	110	92	74	55	46	37	18	0

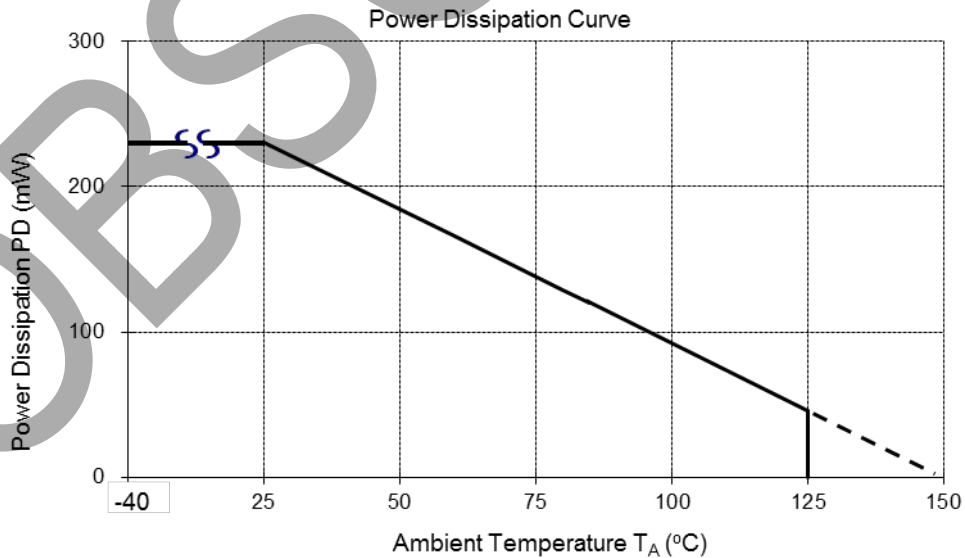

OBSOLETE - PART DISCONTINUED

**Ordering Information**

AH3761-XG-X

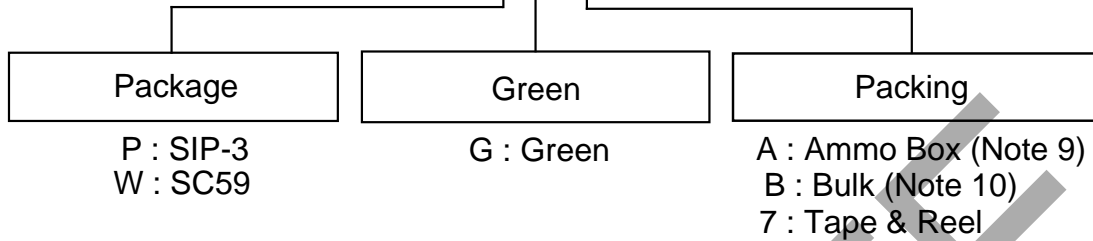

Device	Status (Note 11)	Package Code	Packaging (Note 8)	Bulk		7" Tape and Reel		Ammo Box	
				Quantity	Part Number Suffix	Quantity	Part Number Suffix	Quantity	Part Number Suffix
AH3761-PG-A	EOL	P	SIP-3(Ammo Pack)	NA	NA	NA	NA	4000/Box	-A
AH3761-PG-B	NRND	P	SIP-3(Bulk Pack)	1000	-B	NA	NA	NA	NA
AH3761-WG-7	NRND	W	SC59	NA	NA	3000/Tape & Reel	-7	NA	NA

- Notes:
- 8. Pad layout as shown on Diodes Incorporated's suggested pad layout document, which can be found on our website at <http://www.diodes.com/package-outlines.html>.
  - 9. Ammo Box is for SIP-3 Spread Lead.
  - 10. Bulk is for SIP-3 Straight Lead.
  - 11. NRND = Not Recommended for New Design.  
EOL = End of Life.

OBSOLETE - PART DISCONTINUED

OBSOLETE

**Marking Information**

(1) Package Type: SIP-3 (Ammo Pack), SIP-3 (Bulk Pack)

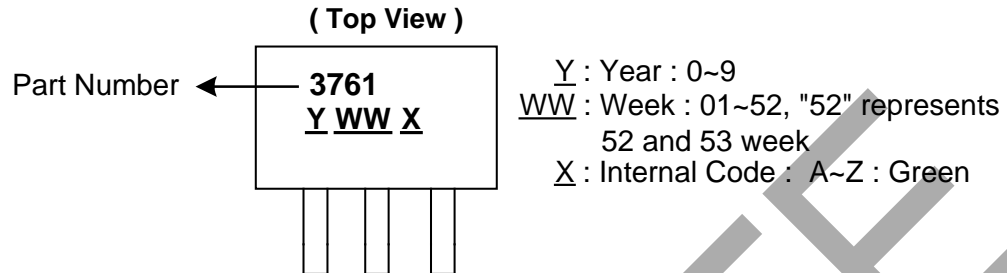

Part Number	Package	Identification Code
AH3761	SIP-3 (Ammo Pack)	3761
AH3761	SIP-3 (Bulk Pack)	3761

(2) Package Type: SC59

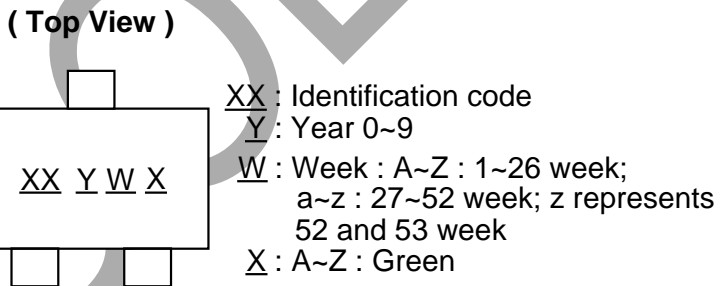

Part Number	Package	Identification Code
AH3761	SC59	P8

OBSOLETE - PART DISCONTINUED

**Package Outline Dimensions** (All Dimensions in mm)

Please see <http://www.diodes.com/package-outlines.html> for the latest version.

(1) Package Type: SIP-3 (Bulk Pack)

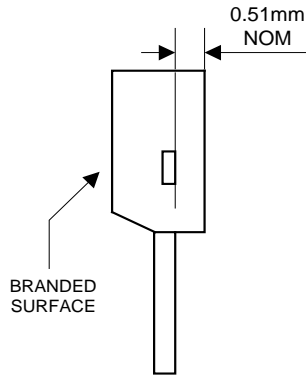

Active Area Depth

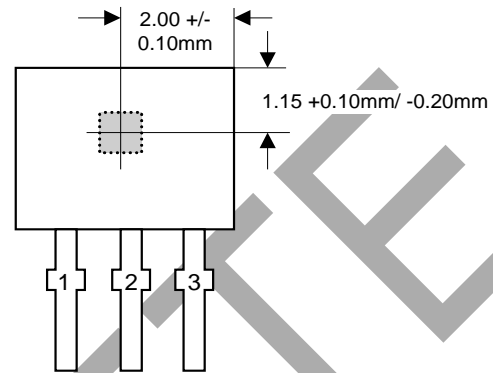

Sensor Location

Package Dimension

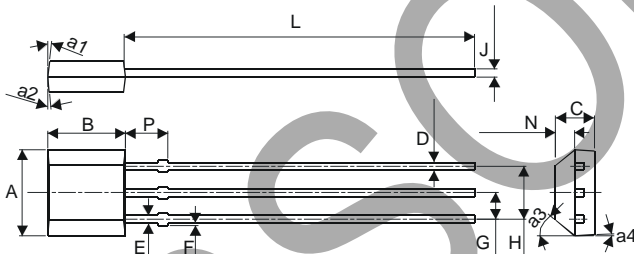

SIP-3 (Bulk Pack)		
Dim	Min	Max
A	3.9	4.3
a1	5	typ
a2	5	□ Ty
a3	45	□ Ty
a4	3	□ Ty
B	2.8	3.2
C	1.40	1.60
D	0.33	0.432
E	0.40	0.508
F	0	0.2
G	1.24	1.30
H	2.51	2.57
J	0.35	0.43
L	14.0	15.0
N	0.63	0.84
P	1.55	-
All Dimensions in mm		

OBSOLETE - PART DISCONTINUED

OBSOLETE

**Package Outline Dimensions (Cont.)**

Please see <http://www.diodes.com/package-outlines.html> for the latest version.

**(2) Package Type: SIP-3 (Ammo Pack)**

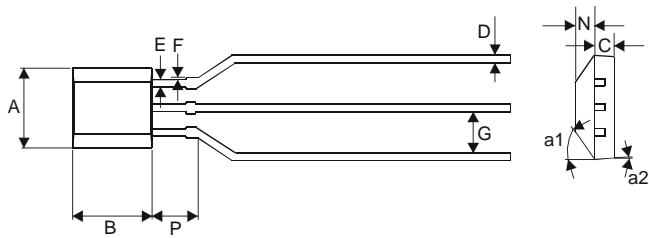

SIP-3 (Ammo Pack)		
Dim	Min	Max
A	3.9	4.3
a1	45	<input type="checkbox"/> Ty
a2	3	<input type="checkbox"/> Ty
B	2.8	3.2
C	1.40	1.00
<input type="checkbox"/>	0.35	0.41
E	0.43	0.48
F	0	0.2
G	2.4	2.9
N	0.63	0.84
P	1.55	-
All Dimensions in mm		

**(3) Package Type: SC59**

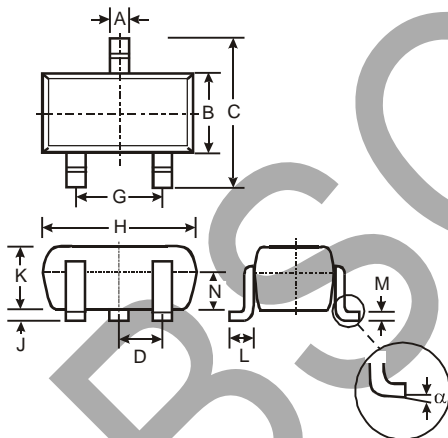

SC59			
Dim	Min	Max	Typ
A	0.35	0.50	0.38
B	1.50	1.70	1.60
C	2.70	3.00	2.80
D	-	-	0.95
G	-	-	1.90
H	2.90	3.10	3.00
J	0.013	0.10	0.05
K	1.00	1.30	1.10
L	0.35	0.55	0.40
M	0.10	0.20	0.15
N	0.70	0.80	0.75
<input type="checkbox"/>	0°	8°	-
All Dimensions in mm			

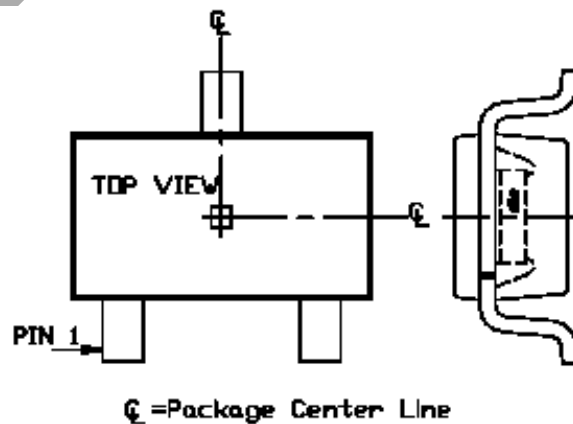

OBSOLETE - PART DISCONTINUED



**Suggested Pad Layout**

Please see <http://www.diodes.com/package-outlines.html> for the latest version.

(1) Package Type: SC59

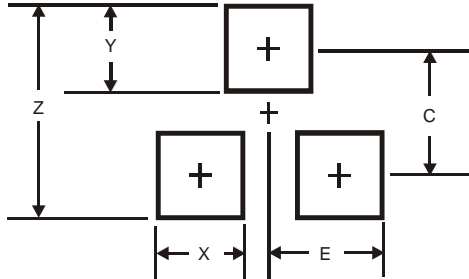

Dimensions	Value (in mm)
Z	3.4
X	0.8
Y	1.0
C	2.4
E	1.35

OBSOLETE - PART DISCONTINUED

OBSOLETE

**IMPORTANT NOTICE**

DIODES INCORPORATED MAKES NO WARRANTY OF ANY KIND, EXPRESS OR IMPLIED, WITH REGARDS TO THIS DOCUMENT, INCLUDING, BUT NOT LIMITED TO, THE IMPLIED WARRANTIES OF MERCHANTABILITY AND FITNESS FOR A PARTICULAR PURPOSE (AND THEIR EQUIVALENTS UNDER THE LAWS OF ANY JURISDICTION).

Diodes Incorporated and its subsidiaries reserve the right to make modifications, enhancements, improvements, corrections or other changes without further notice to this document and any product described herein. Diodes Incorporated does not assume any liability arising out of the application or use of this document or any product described herein; neither does Diodes Incorporated convey any license under its patent or trademark rights, nor the rights of others. Any Customer or user of this document or products described herein in such applications shall assume all risks of such use and will agree to hold Diodes Incorporated and all the companies whose products are represented on Diodes Incorporated website, harmless against all damages.

Diodes Incorporated does not warrant or accept any liability whatsoever in respect of any products purchased through unauthorized sales channel. Should Customers purchase or use Diodes Incorporated products for any unintended or unauthorized application, Customers shall indemnify and hold Diodes Incorporated and its representatives harmless against all claims, damages, expenses, and attorney fees arising out of, directly or indirectly, any claim of personal injury or death associated with such unintended or unauthorized application.

Products described herein may be covered by one or more United States, international or foreign patents pending. Product names and markings noted herein may also be covered by one or more United States, international or foreign trademarks.

This document is written in English but may be translated into multiple languages for reference. Only the English version of this document is the final and determinative format released by Diodes Incorporated.

**LIFE SUPPORT**

Diodes Incorporated products are specifically not authorized for use as critical components in life support devices or systems without the express written approval of the Chief Executive Officer of Diodes Incorporated. As used herein:

A. Life support devices or systems are devices or systems which:

1. are intended to implant into the body, or
2. support or sustain life and whose failure to perform when properly used in accordance with instructions for use provided in the labeling can be reasonably expected to result in significant injury to the user.

B. A critical component is any component in a life support device or system whose failure to perform can be reasonably expected to cause the failure of the life support device or to affect its safety or effectiveness.

Customers represent that they have all necessary expertise in the safety and regulatory ramifications of their life support devices or systems, and acknowledge and agree that they are solely responsible for all legal, regulatory and safety-related requirements concerning their products and any use of Diodes Incorporated products in such safety-critical, life support devices or systems, notwithstanding any devices- or systems-related information or support that may be provided by Diodes Incorporated. Further, Customers must fully indemnify Diodes Incorporated and its representatives against any damages arising out of the use of Diodes Incorporated products in such safety-critical, life support devices or systems.

Copyright © 2019, Diodes Incorporated

[www.diodes.com](http://www.diodes.com)

# Mouser Electronics

Authorized Distributor

Click to View Pricing, Inventory, Delivery & Lifecycle Information:

[Diodes Incorporated:](#)

[AH3761-PG-A](#) [AH3761-PG-B](#) [AH3761-WG-7](#)