

Description

The AH1912 is an ultra-low power digital Omni-polar Hall Effect switch IC from Diodes broad Hall Effect switches family. Thanks to the hibernating clocking system, the average supply current is only 1.6 μ A at 3V, which makes the AH1912 perfectly fit battery-powered consumer products, Gas or water meter, smoke detectors and IoT devices. The wider range of supply voltage (1.6V to 5.5V) extends battery operating time and supports low voltage system microcontrollers, which provides great flexibility for system design. The advanced chopper stabilized design provides superior stability on switch operating point over temperature and supply voltage. The high ESD level up to 6kV helps to improve the system robustness.

The output is activated with either a north or south pole of sufficient magnetic field strength. When the magnetic flux density (B) perpendicular to the package is larger than operate point (B_{OP}), the output will be turned on (pulled low) and held until B is lower than release point (B_{RP}).

The AH1912 comes with industry standard SC59 and X1-DFN1216-4 packages.

Features

- Omni-Polar Operation (North or South Pole)
- Supply Voltage of 1.6V to 5.5V
- Micro Power Operation
- Chopper Stabilized Design Provides:
 - Superior Temperature Stability
 - Minimal Switch Point Drift
 - Enhanced Immunity to Physical Stress
- No External Pull-Up Resistors Required
- Good RF Noise Immunity
- -40°C to +85°C Operating Temperature
- High ESD Capability of 6kV (Human Body Model)
- Small Low Profile, SC59 and X1-DFN1216-4 Packages
- **Totally Lead-Free & Fully RoHS Compliant (Notes 1 & 2)**
- **Halogen and Antimony Free. "Green" Device (Note 3)**

- Notes:
1. No purposely added lead. Fully EU Directive 2002/95/EC (RoHS), 2011/65/EU (RoHS 2) & 2015/863/EU (RoHS 3) compliant.
 2. See <https://www.diodes.com/quality/lead-free/> for more information about Diodes Incorporated's definitions of Halogen- and Antimony-free, "Green" and Lead-free.
 3. Halogen- and Antimony-free "Green" products are defined as those which contain <900ppm bromine, <900ppm chlorine (<1500ppm total Br + Cl) and <1000ppm antimony compounds.

Pin Assignments

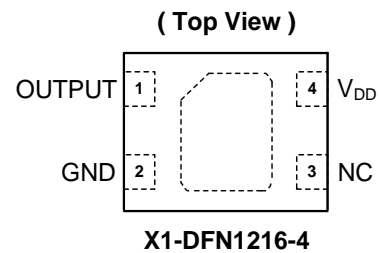
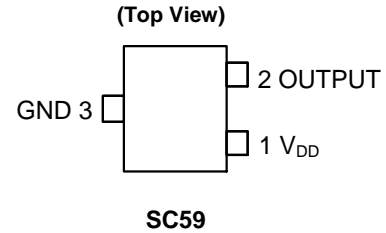

Applications

- Smart Cover or Dock Detect for Cellular Phones and Tablet PCs
- Gas or Water Consumption Measurement in Remote, Battery-Operated Utility Meters
- Medical Devices, IoT Systems
- Level, Proximity and Position Switches
- E-Locks, Smoke Detectors, Appliances

Typical Applications Circuit (Note 4)

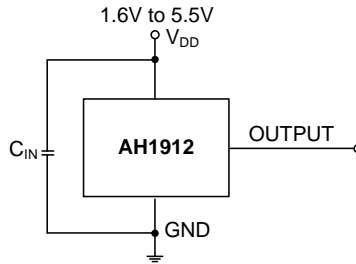

Note: 4. C_{IN} is for power stabilization and to strengthen the noise immunity, the recommended capacitance is 100nF typical and should be placed as close to the supply pin as possible.

Pin Descriptions

(1) Package: SC59

Pin Number	Pin Name	Function
1	V_{DD}	Power Supply Input
2	OUTPUT	Output Pin
3	GND	Ground Pin

(2) Package: X1-DFN1216-4

Pin Number	Pin Name	Function
1	OUTPUT	Output Pin
2	GND	Ground Pin
3	NC	No Connection (Note 5)
4	V_{DD}	Power Supply Input
Pad	Pad	The center exposed pad – No connection internally. The exposed pad can be left open (unconnected to) on the PCB layout.

Note: 5. NC is "No Connection" pin and is not connected internally. This pin can be left open or tied to ground.

Functional Block Diagram

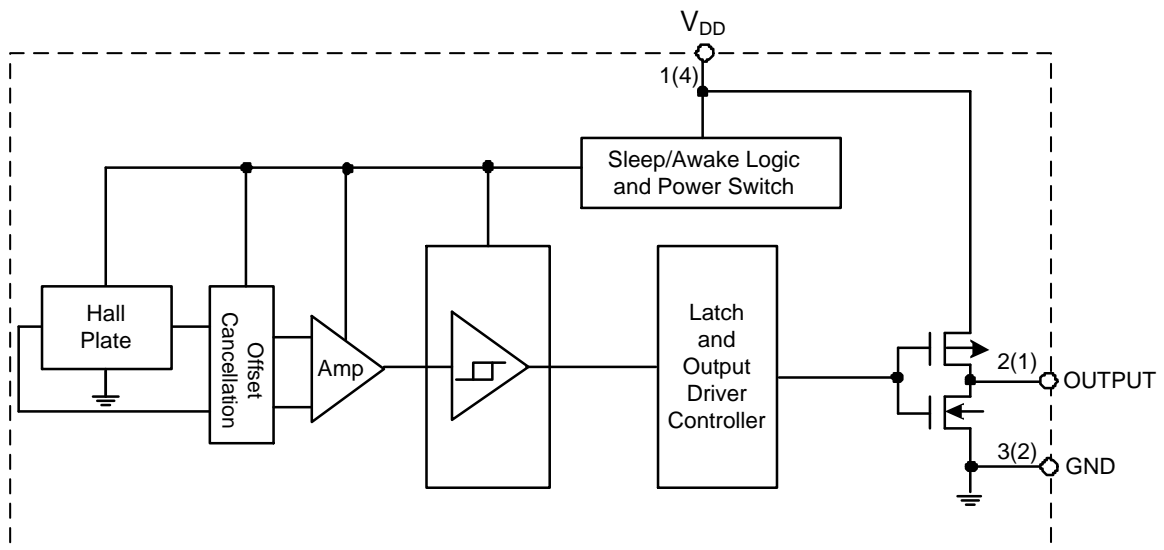

A(B)
A for SC59
B for X1-DFN1216-4

Absolute Maximum Ratings (Note 6) (@ $T_A = +25^\circ\text{C}$, unless otherwise specified.)

Symbol	Parameter	Rating	Unit
V_{DD}	Supply Voltage (Note 7)	6	V
V_{DD_REV}	Reverse Supply Voltage	-0.3	V
I_{OUTPUT}	Output Current (Source and Sink)	1	mA
B	Magnetic Flux Density	Unlimited	
P_D	Package Power Dissipation	SC59 and X1-DFN1216-4	230 mW
T_S	Storage Temperature Range	-65 to +150	$^\circ\text{C}$
T_J	Maximum Junction Temperature	+150	$^\circ\text{C}$
ESD HBM	Human Body Model (HBM) ESD Capability	6	kV

- Notes:
- Stresses greater than the 'Absolute Maximum Ratings' specified above can cause permanent damage to the device. These are stress ratings only; functional operation of the device at these or any other conditions exceeding those indicated in this specification is not implied. Device reliability can be affected by exposure to absolute maximum rating conditions for extended periods of time.
 - The absolute maximum V_{DD} of 6V is a transient stress rating and is not meant as a functional operating condition. It is not recommended to operate the device at the absolute maximum rated conditions for any period of time.

Recommended Operating Conditions (@ $T_A = +25^\circ\text{C}$, unless otherwise specified.)

Symbol	Parameter	Conditions	Rating	Unit
V_{DD}	Supply Voltage	Operating	1.6V to 5.5V	V
T_A	Operating Temperature Range	Operating	-40 to +85	$^\circ\text{C}$

Electrical Characteristics (@ $T_A = +25^\circ\text{C}$, $V_{DD} = 3\text{V}$, unless otherwise specified.)

Symbol	Parameter	Conditions	Min	Typ	Max	Unit
V_{OL}	Output Low Voltage (On)	$I_{OUT} = 0.1\text{mA}$	—	0.1	0.2	V
V_{OH}	Output High Voltage (Off)	$I_{OUT} = -0.1\text{mA}$	$V_{DD}-0.2$	$V_{DD}-0.1$	—	V
$I_{DD(AWAKE)}$	Supply Current	$T_A = +25^\circ\text{C}$, $V_{DD} = 3\text{V}$	—	1	1.5	mA
		$T_A = -40$ to $+85^\circ\text{C}$, $V_{DD} = 1.6\text{V}$ to 5.5V	—	1	3	mA
$I_{DD(SLEEP)}$	Supply Current	$T_A = +25^\circ\text{C}$, $V_{DD} = 3\text{V}$	—	0.6	1	μA
		$T_A = -40$ to $+85^\circ\text{C}$, $V_{DD} = 1.6\text{V}$ to 5.5V	—	0.6	3	μA
$I_{DD(AVG)}$	Average Supply Current	$T_A = +25^\circ\text{C}$, $V_{DD} = 3\text{V}$	—	1.6	3	μA
		$T_A = -40$ to $+85^\circ\text{C}$, $V_{DD} = 1.6\text{V}$ to 5.5V	—	1.6	9	μA
t_{AWAKE}	Awake Time	(Note 8)	30	45	80	μs
t_{PERIOD}	Period	(Note 8)	30	45	80	ms
D.C.	Duty Cycle	—	—	0.1	—	%

- Note: 8. When power is initially turned on, the operating V_{DD} (1.6V to 5.5V) must be applied to guaranteed the output sampling. The output state is valid after the second operating cycle (typical 90ms).

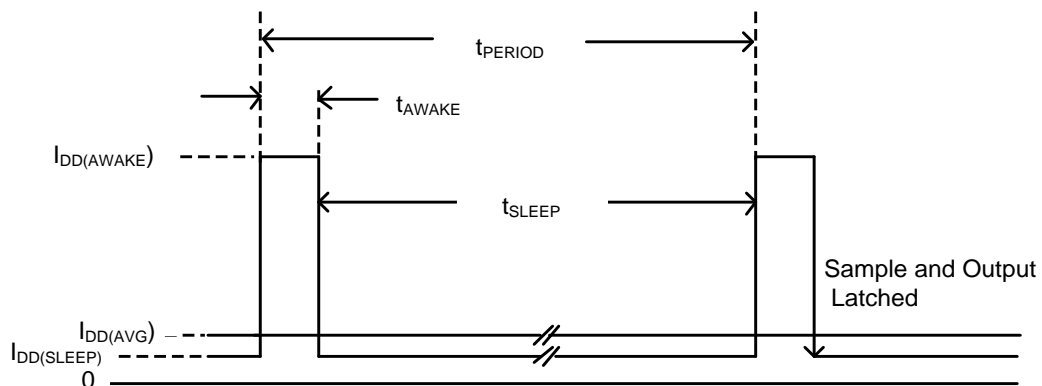

Magnetic Characteristics (Note 9) ($T_A = +25^\circ\text{C}$, $V_{DD} = 3\text{V}$, unless otherwise specified.)

(1mT=10 Gauss)

Symbol	Characteristics	Test Condition	Min	Typ	Max	Unit
B_{OPS} (South Pole to the Part Marking Side)	Operation Point	—	21	30	39	Gauss
		$V_{DD} = 1.6\text{V to } 5.5\text{V}$ $T_A = -40^\circ\text{C to } +85^\circ\text{C}$	19	30	42	
B_{OPN} (North Pole to the Part Marking Side)	Operation Point	—	-39	-30	-21	
		$V_{DD} = 1.6\text{V to } 5.5\text{V}$ $T_A = -40^\circ\text{C to } +85^\circ\text{C}$	-42	-30	-19	
B_{RPS} (South Pole to the Part Marking Side)	Release Point	—	14	23	30	
		$V_{DD} = 1.6\text{V to } 5.5\text{V}$ $T_A = -40^\circ\text{C to } +85^\circ\text{C}$	12	23	33	
B_{RPN} (North Pole to the Part Marking Side)	Release Point	—	-30	-23	-14	
		$V_{DD} = 1.6\text{V to } 5.5\text{V}$ $T_A = -40^\circ\text{C to } +85^\circ\text{C}$	-33	-23	-12	
B_{HY} ($ B_{OPX} - B_{RPX} $)	Hysteresis	—	2	7	—	

Note: 9. Maximum and minimum parameters values over operating temperature range are not tested in production, they are guaranteed by design, characterization and process control. The magnetic characteristics may vary with supply voltage, operating temperature and after soldering.

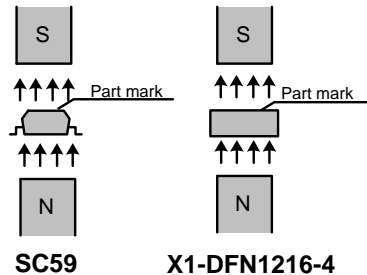
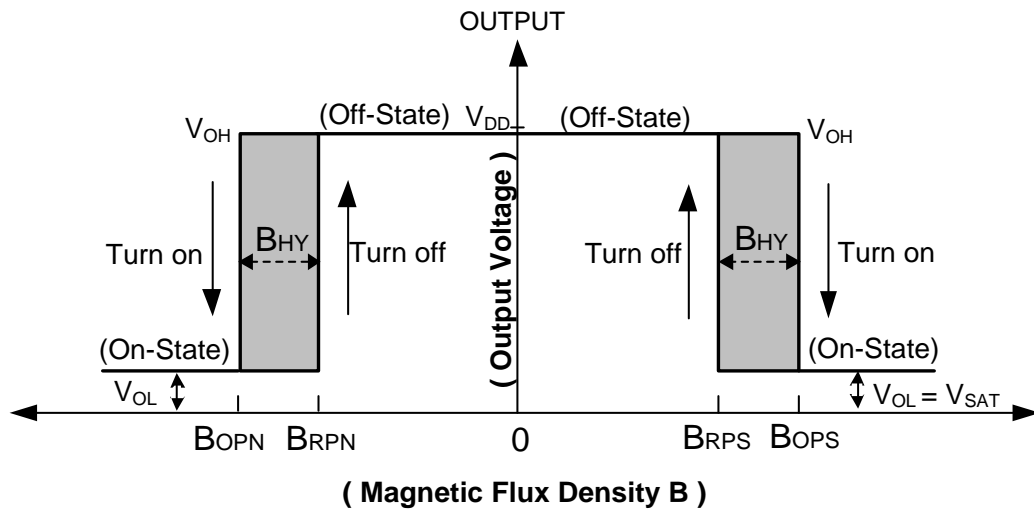

NEW PRODUCT

Typical Operating Characteristics

Output Switch Operate and Release Points (Magnetic Thresholds)

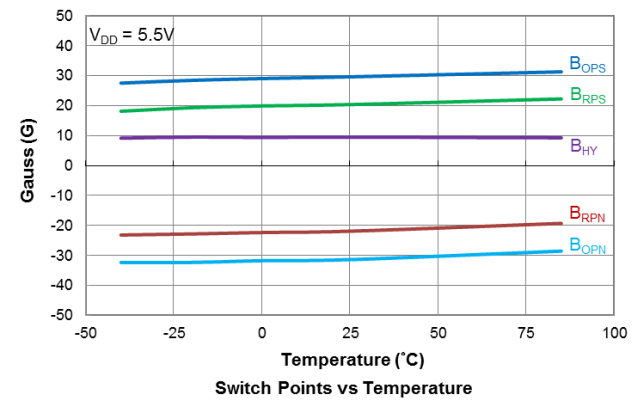
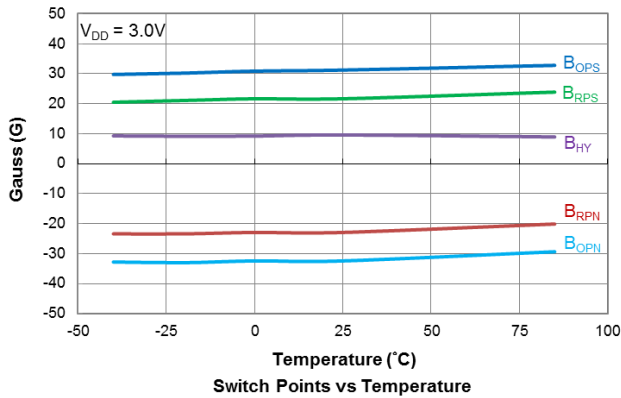
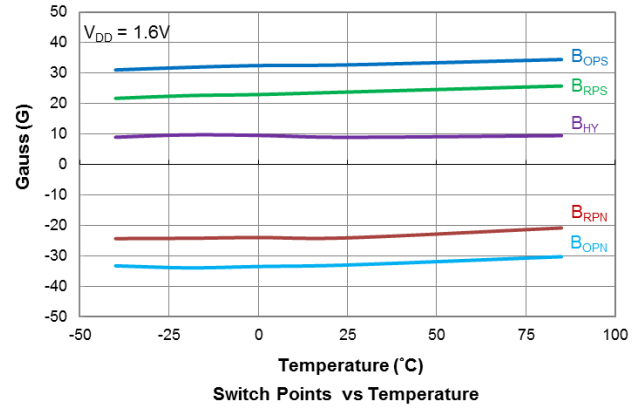
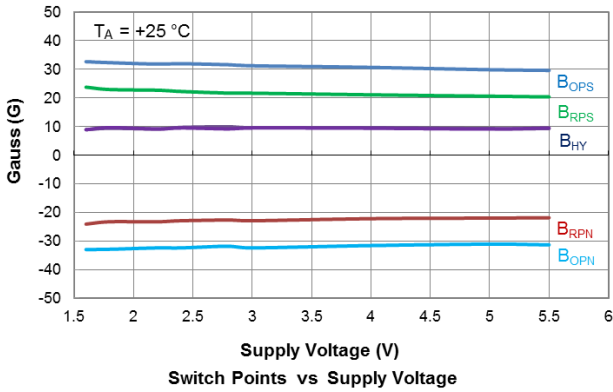

Average Supply Current

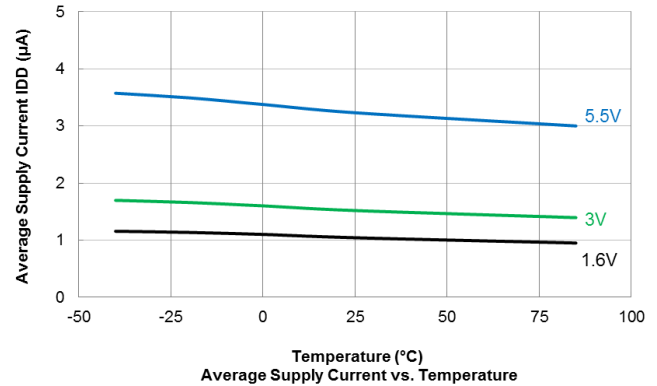
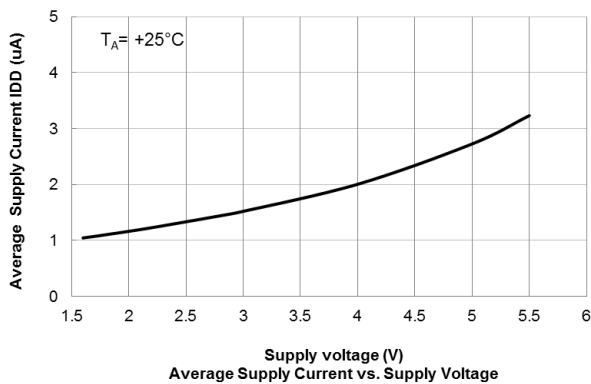

Ordering Information

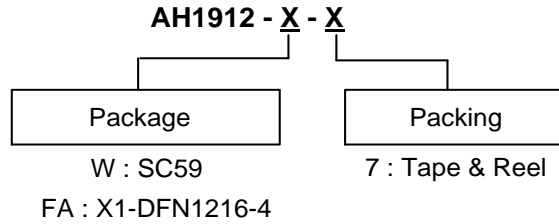

Part Number	Package Code	Packaging	7" Tape and Reel	
			Quantity	Part Number Suffix
AH1912-W-7	W	SC59	3000/Tape and Reel	-7
AH1912-FA-7	FA	X1-DFN1216-4	3000/Tape and Reel	-7

Marking Information

(1) Package Type: SC59

(Top View)

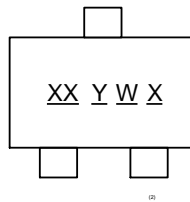

XX : Identification Code
Y : Year 0 to 9
W : Week : A to Z : 1 to 26 week;
 a to z : 27 to 52 week; z represents
 52 and 53 week
X : Internal Code

Part Number	Package	Identification Code
AH1912-W-7	SC59	KX

(2) Package Type: X1-DFN1216-4

(Top View)

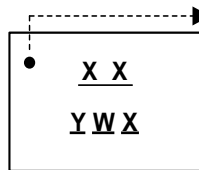

Pin 1 Indicator
XX : Identification Code
Y : Year : 0~9
W : Week : A~Z : 1~26 week;
 a~z : 27~52 week; z represents
 52 and 53 week
X : Internal Code

Part Number	Package	Identification Code
AH1912-FA-7	X1-DFN1216-4	KX

Package Outline Dimensions

Please see <http://www.diodes.com/package-outlines.html> for the latest version.

(1) Package Type: SC59

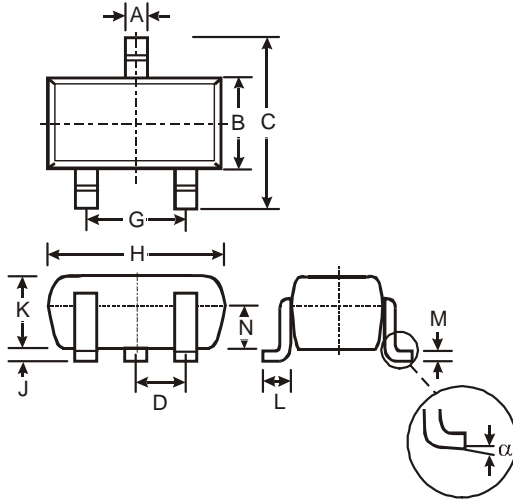

SC59			
Dim	Min	Max	Typ
A	0.35	0.50	0.38
B	1.50	1.70	1.60
C	2.70	3.00	2.80
D	—	—	0.95
G	—	—	1.90
H	2.90	3.10	3.00
J	0.013	0.10	0.05
K	1.00	1.30	1.10
L	0.35	0.55	0.40
M	0.10	0.20	0.15
N	0.70	0.80	0.75
α	0°	8°	—

All Dimensions in mm

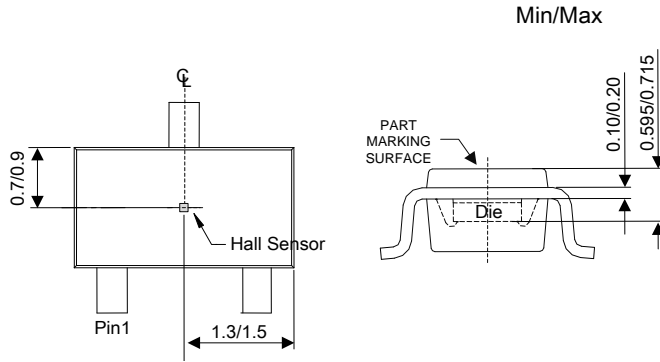

Sensor Location

NEW PRODUCT

Package Outline Dimensions (continued)

Please see <http://www.diodes.com/package-outlines.html> for the latest version.

(2) Package Type: X1-DFN1216-4

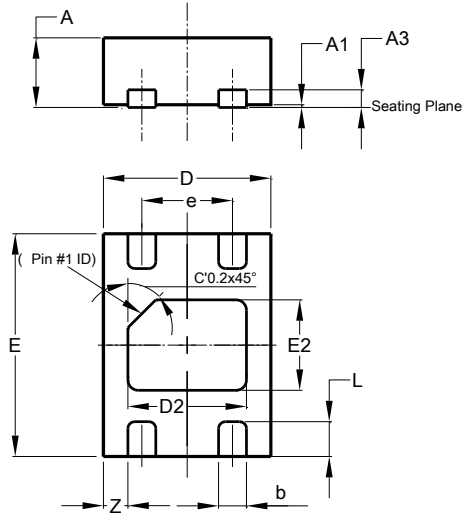

X1-DFN1216-4			
Dim	Min	Max	Typ
A	0.47	0.53	0.50
A1	0.00	0.05	0.02
A3	—	—	0.13
b	0.15	0.25	0.20
D	1.15	1.25	1.20
D2	0.75	0.95	0.85
E	1.55	1.65	1.60
E2	0.55	0.75	0.65
e	—	—	0.65
L	0.20	0.30	0.25
Z	—	—	0.175
All Dimensions in mm			

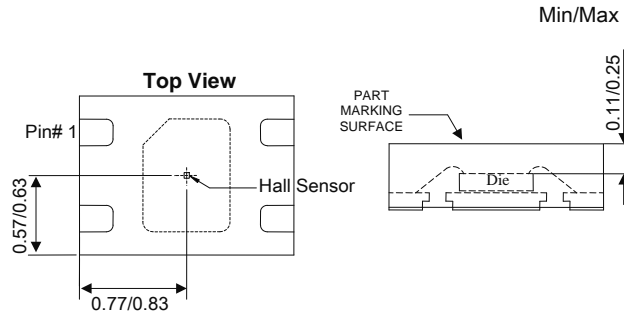

Sensor Location

NEW PRODUCT

Suggested Pad Layout

Please see <http://www.diodes.com/package-outlines.html> for the latest version.

(1) Package Type: SC59

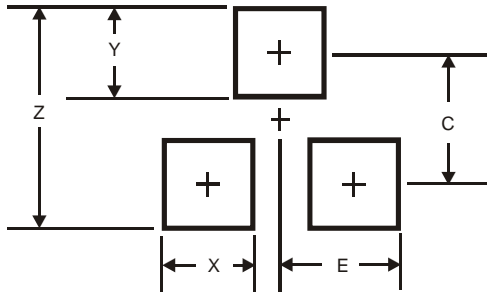

Dimensions	Value (in mm)
Z	3.4
X	0.8
Y	1.0
C	2.4
E	1.35

(2) Package Type: X1-DFN1216-4

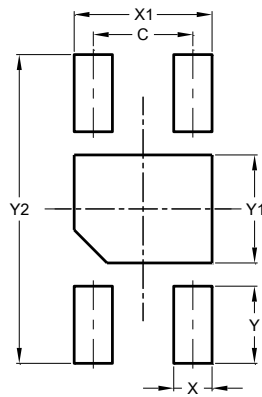

X1-DFN1216-4	
Dimensions	Value (in mm)
C	0.65
X	0.25
X1	0.90
Y	0.50
Y1	0.70
Y2	2.00

IMPORTANT NOTICE

DIODES INCORPORATED MAKES NO WARRANTY OF ANY KIND, EXPRESS OR IMPLIED, WITH REGARDS TO THIS DOCUMENT, INCLUDING, BUT NOT LIMITED TO, THE IMPLIED WARRANTIES OF MERCHANTABILITY AND FITNESS FOR A PARTICULAR PURPOSE (AND THEIR EQUIVALENTS UNDER THE LAWS OF ANY JURISDICTION).

Diodes Incorporated and its subsidiaries reserve the right to make modifications, enhancements, improvements, corrections or other changes without further notice to this document and any product described herein. Diodes Incorporated does not assume any liability arising out of the application or use of this document or any product described herein; neither does Diodes Incorporated convey any license under its patent or trademark rights, nor the rights of others. Any Customer or user of this document or products described herein in such applications shall assume all risks of such use and will agree to hold Diodes Incorporated and all the companies whose products are represented on Diodes Incorporated website, harmless against all damages.

Diodes Incorporated does not warrant or accept any liability whatsoever in respect of any products purchased through unauthorized sales channel. Should Customers purchase or use Diodes Incorporated products for any unintended or unauthorized application, Customers shall indemnify and hold Diodes Incorporated and its representatives harmless against all claims, damages, expenses, and attorney fees arising out of, directly or indirectly, any claim of personal injury or death associated with such unintended or unauthorized application.

Products described herein may be covered by one or more United States, international or foreign patents pending. Product names and markings noted herein may also be covered by one or more United States, international or foreign trademarks.

This document is written in English but may be translated into multiple languages for reference. Only the English version of this document is the final and determinative format released by Diodes Incorporated.

LIFE SUPPORT

Diodes Incorporated products are specifically not authorized for use as critical components in life support devices or systems without the express written approval of the Chief Executive Officer of Diodes Incorporated. As used herein:

A. Life support devices or systems are devices or systems which:

1. are intended to implant into the body, or
2. support or sustain life and whose failure to perform when properly used in accordance with instructions for use provided in the labeling can be reasonably expected to result in significant injury to the user.

B. A critical component is any component in a life support device or system whose failure to perform can be reasonably expected to cause the failure of the life support device or to affect its safety or effectiveness.

Customers represent that they have all necessary expertise in the safety and regulatory ramifications of their life support devices or systems, and acknowledge and agree that they are solely responsible for all legal, regulatory and safety-related requirements concerning their products and any use of Diodes Incorporated products in such safety-critical, life support devices or systems, notwithstanding any devices- or systems-related information or support that may be provided by Diodes Incorporated. Further, Customers must fully indemnify Diodes Incorporated and its representatives against any damages arising out of the use of Diodes Incorporated products in such safety-critical, life support devices or systems.

Copyright © 2019, Diodes Incorporated

www.diodes.com

Mouser Electronics

Authorized Distributor

Click to View Pricing, Inventory, Delivery & Lifecycle Information:

[Diodes Incorporated:](#)

[AH1912-W-7](#) [AH1912-FA-7](#)