

Pressure Switch/Reed Switch Type

IS10 Series

16% lighter

Weight: 62 g

*Previous type 74 g
Compared with IS1000
(Made by SMC)

11% smaller

Overall height: 52 mm

*Previous type 58.5 mm
Compared with IS1000
(Made by SMC)

- 100 V AC/DC specifications
- Set pressure range
0.1 to 0.4 MPa
- Service life: **5 million cycles**



Pressure switch with spacer



Pressure switch with piping adapter



RoHS

- Can be connected to Modular type F.R.L. units.

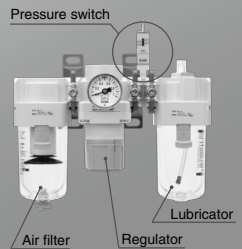

Specifications

Model	IS10-01
Fluid	Air/Inert gas
Proof pressure	1.0 MPa
Max. operating pressure	0.7 MPa
Set pressure range	0.1 to 0.4 MPa Option: 0.1 to 0.6 MPa
Ambient and fluid temperature	-5 to 60°C (No freezing)
Contacts	1a
Error of scale	±0.05 MPa or less
Hysteresis	Fixed 0.08 MPa or less
Repeatability	±0.05 MPa or less
Wiring specifications	Grommet, Lead wire length: 0.5 m Option: 3 m, 5 m
Enclosure	Equivalent to IP40
Port size	1/8
Weight	62 g

Switch Characteristics

Max. contact capacity	AC 2 VA, DC 2 W		
Voltage AC/DC	24 V or less	48 V	100 V
Max. operating current and range	50 mA	40 mA	20 mA

Electrical Circuit

Up to 100 V AC/DC

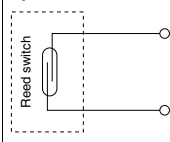

Symbol

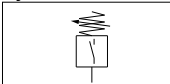

Set Pressure Range

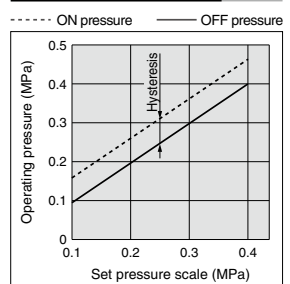

How to Order

IS10- 01 -

	Symbol	Description		
①	Nil	R		
	N	NPT		
②	Nil	None		
	S	With seal		
③	a	Set pressure range	Nil + 0.1 to 0.4 MPa	
		6 Note(1)	0.1 to 0.6 MPa	
	b	Lead wire length	L	0.5 m
			Z	3 m
			Z	5 m
	c	Scale plate pressure unit	Nil	MPa
P Note(2)			Both MPa and psi	

Semi-standard: Select one option each in a through c. Place them in alphabetical order.

Example) IS10-N01-6PZ

Note 1) Set pressure range of 6P(L, Z) is 0.2 to 0.6 MPa (30 to 90 psi).

Note 2) This product is for overseas use only according to the new Measurement Law. (The SI unit type is provided for use in Japan.)

ZSE20
ISE20

ZSE30
ISE30

ZSE40
ISE40

ZSE10
ISE10

ISE70

ZSE80
ISE80

PS

ISA3

ISA2

ISE35

PSE

IS

ISG

ZSM1

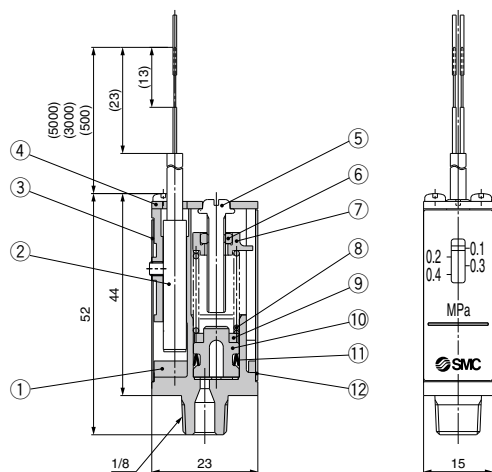

Component Parts

No.	Description	Material
1	Body	ZDC
2	Switch assembly	—
3	Shield plate	Steel sheet
4	Cover	Steel sheet
5	Adjusting screw	Brass
6	Hexagon nut	Brass
7	Indicator	PBT
8	Spring	Stainless steel
9	Magnet	—
10	Piston	POM
11	Seal piston	NBR
12	Scale plate	PC

Wiring

⚠ Warning

1. Connect load before connecting with power source.

The switch will break instantly if no load is connected.

2. Make the wiring length as short as possible. When the load which is operated by the pressure switch is an inductive load, or the lead wire is 5 m or longer, use the contact protection box shown in the table below.

Otherwise, damage to the switch can result.

Part no.	Voltage	Lead wire length
CD-P11	100 VAC	Switch side: 0.5 m
CD-P12	24 VDC	Load side: 0.5 m

- Internal circuit of contact protection box

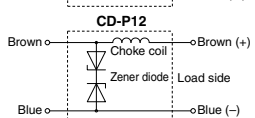
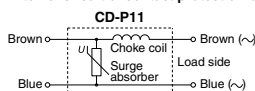

- How to connect contact protection box
Connect the lead wires from the body and the contact protective box side indicated "SWITCH." Make the lead wire as short as possible, within 1 m.

3. Dimensions of lead wire

Enclosure: ϕ 3.4
Insulator: ϕ 1.1
Conductor: ϕ 0.64

For details, refer to the operation manual.

Mounting

⚠ Warning

1. When handling the product, hold the body and do not apply tensile stress to the power supply cable. Otherwise, damage may occur to the product.
2. Avoid repeatedly bending or stretching the lead wire.
Wiring which applies repeated bending and tensile stress to the lead wire can break the circuit. If the lead wire is damaged, causing operation failure, replace the product with a new one.
3. Do not drop or bump the product when handling the product.
4. Apply a wrench to the bottom of the product when screwing.
Turning it by applying a wrench on the top of the main body may cause damage to the product.
Recommended tightening torque: 7 to 9 N·m

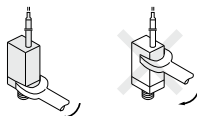

5. Mounting direction is available in either horizontal or perpendicular.

Operating Environment

⚠ Warning

1. Avoid using a switch in a magnetic environment. It may cause a malfunction.
2. Do not use in such an environment, where water or oil is splashed.
Since it is the open type construction, if water or oil make an ingress into the internal parts, the electric circuit will be corroded and may result in a malfunction or damage.
3. Avoid vibration.
Vibration may cause a malfunction or may cause setting to be incorrect.

Pressure Source

⚠ Warning

1. Operating fluids are either air or inert gas exclusively.
Never use other fluids. Never use in an environment where flammable fluid or gas is used. Since this is not an explosion-proof construction, it may lead to an explosive disaster.
2. Not applicable to corrosive gas and liquid.
Otherwise, damage to the body or liquid leakage can result.
3. Avoid use in vacuum applications.
Switch may be imploded.
4. This product (IS10 series) uses a reed switch. If the chattering of the output signal is a problem, choose a solid state type pressure switch or adjust by PLC.

Pressure Setting

⚠ Warning

1. Set within the display pressure range of the scale plate.

⚠ Caution

1. The pressure can be adjusted by rotating the adjustment screw. The red indicator goes up and down according to the adjustment. Rotate the screw clockwise for high pressure.
2. Use a screwdriver of a size suitable for the groove of the adjustment screw.
3. Scale of switching set display is the set value at the pressure drop.
4. The ON signal is output through the pressure set on the scale plate, to which the hysteresis is added for detecting the ON-pressure signal.
5. The pressure displayed on the scale plate is a guideline only.
Measure the accurate pressure with the pressure gauge.

Pressure Switch for Connecting to Modular/F.R.L. Units

Pressure Switch with Spacer

IS10M-30-□-A

① ②

Semi-standard: Select one option each in a through c. Place them in alphabetical order.
Example) IS10M-6LP-A

		Symbol	Description	① Body size				
				20	30	40	50	60
② Semi-standard	a	Set pressure range	NH 0.1 to 0.4 MPa 6 ^{Note 1)} 0.1 to 0.6 MPa	●	●	●	●	●
	+							
	b	Lead wire length	NH 0.5 m L 3 m Z 5 m	●	●	●	●	●
+								
c	Scale plate pressure unit	NH MPa P ^{Note 2)} Both MPa and psi	●	●	●	●	●	

Note 1) Set pressure range of 6P(L, Z) is 0.2 to 0.6 MPa (30 to 90 psi).
Note 2) This product is for overseas use only according to the new Measurement Law. (The SI unit type is provided for use in Japan.)

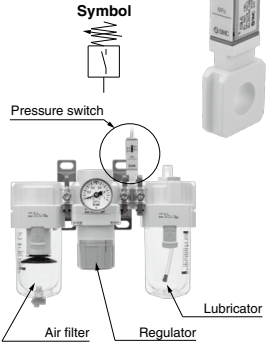
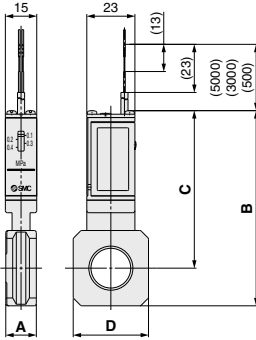

Model	A	B	C	D	Applicable model
IS10M-20-A	11	74	64	28	AC20□-A
IS10M-30-A	13	85	71	30	AC25□-A, AC30□-A
IS10M-40-A	15	93	75	36	AC40□-A
IS10M-50-A	17	97	77	44	AC40□-06-A
IS10M-60-A	22	91	67	53	AC50□-B, AC55□-B, AC60□-B

Note) Prepare a spacer separately for modular connection.

Pressure Switch with Piping Adapter

IS10E-30-□-03-□-A

① ② ③ ④

Semi-standard: Select one option each in a through d. Place them in alphabetical order.
Example) IS10E-30N03-6PRZ-A

		Symbol	Description	① Body size		
				20	30	40
②	Thread type	NH N F	Rc NPT G	●	●	●
	+					
	③	Port size	01	1/8	●	—
02			1/4	—	●	—
03			3/8	—	●	●
04			1/2	—	—	●
06		3/4	—	—	●	
④ Semi-standard	a	Set pressure range	NH 0.1 to 0.4 MPa 6 ^{Note 1)} 0.1 to 0.6 MPa	●	●	●
	+					
	b	Lead wire length	NH 0.5 m L 3 m Z 5 m	●	●	●
	+					
c	Scale plate pressure unit	NH MPa P ^{Note 2)} Both MPa and psi	●	●	●	
+						
d	Mounting position	NH Right R Left	●	●	●	

Note 1) Set pressure range of 6P(L, R, Z) is 0.2 to 0.6 MPa (30 to 90 psi).
Note 2) For thread type: NPT only.

This product is for overseas use only according to the new Measurement Law. (The SI unit type is provided for use in Japan.)

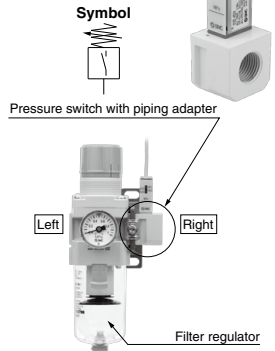
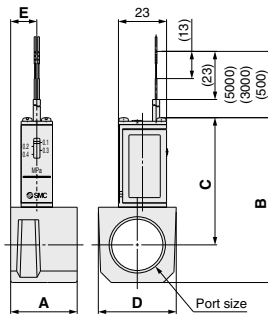

Model (Note 1)	Port size	A	B	C	D	E	Applicable model
IS10E-20□01-A	1/8	30	66	55	28	16	AC20□-A
IS10E-20□02-A	1/4						
IS10E-20□03-A	3/8						
IS10E-30□02-A	1/4	32	73	59	30	13	AC25□-A, AC30□-A
IS10E-30□03-A	3/8						
IS10E-30□04-A	1/2						
IS10E-40□02-A	1/4	32	79	61	37	13	Note 2) AC40□-A
IS10E-40□03-A	3/8						
IS10E-40□04-A	1/2						
IS10E-40□06-A	3/4						

Note 1) □ in the model numbers indicates a thread type. No indication is necessary for Rc; however, indicate N for NPT, and F for G.

Note 2) Cannot be mounted to the AC40□-06-A.

* Prepare a spacer separately for modular connection.

† The pressure switch can be mounted on the AC40□-06-A by screwing the IS10-01S into the piping adapter E50□-06-A-X501 (Rc1/8 threaded on top surface). Products with a pre-mounted switch are available as a special order. Please contact SMC beforehand.

For details, refer to "Modular/F.R.L. Units, AC series" in Best Pneumatics No.6.