

Click to
ORDER
samples

AM20EWM-NZ



Encapsulated

The AM20EWM-NZ is a brand-new 20W medical grade DC/DC converter that offers 4:1 ultra-wide input voltage range and meets the 2xMOPP EN60601-1 third edition medical grade standard. This series will offer many benefits to your new medical grade system design for high isolation requirement. This series offers great operating temperatures, from -40°C to +85°C with full power up to 55°C. It also features an isolation of 5000VAC for improved reliability and system safety. Furthermore, a higher MTBF of 1,000,000h, output short circuit protection (OSCP), output over-current protection (OCP), output over-voltage protection (OVP) and input under-voltage protection (UVLO) come standard with the series. The AM20EWM-NZ is perfect for high insulation required area such as medical applications.

Features



- Operating Temp: -40 °C to +85 °C
- High isolation voltage: 5000VAC
- Low ripple & noise, 200mV (p-p), max.
- Regulated Output
- Output short circuit, over-current, over-voltage, input under-voltage protection
- Design to meet 2xMOPP EN60601-1 medical standard

Summary

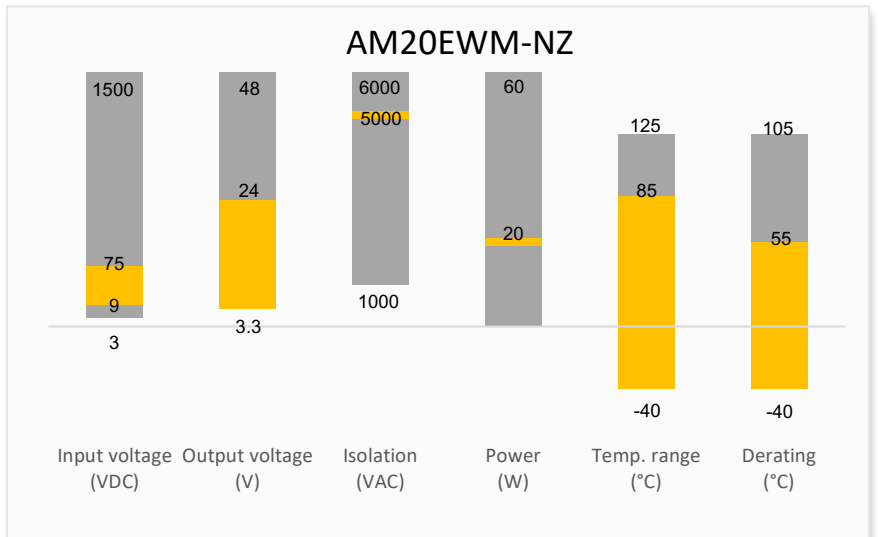

Training

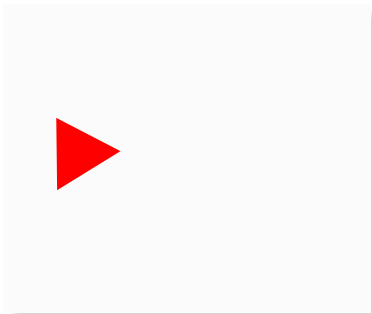

Product Training Video
(click to open)

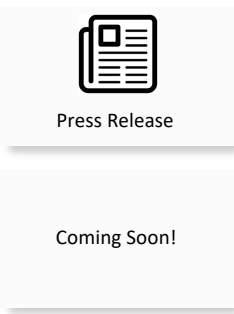

Application Notes

Applications

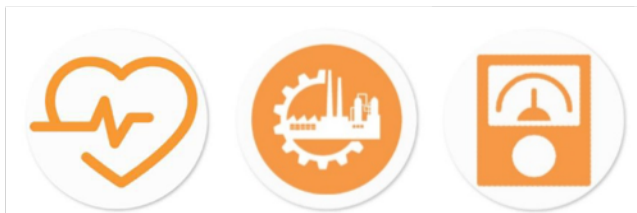

Medical

Industrial

Instrumentation

Models & Specifications

Single Output							
Model	Input Voltage (VDC)	Output Voltage (VDC)	Input Current Max (mA)		Output Current Max (mA)	Maximum Capacitive Load (μF)	Efficiency (%) Full Load Typ.
			No Load	Full Load			
AM20EWM-2403SH50NZ	24 (9-36)	3.3	50	992	5000	10000	85
AM20EWM-2405SH50NZ	24 (9-36)	5	50	992	4000	10000	86
AM20EWM-2412SH50NZ	24 (9-36)	12	15	992	1666	4700	86
AM20EWM-2415SH50NZ	24 (9-36)	15	15	992	1333	1600	87
AM20EWM-2424SH50NZ	24 (9-36)	24	15	992	833	470	89
AM20EWM-4803SH50NZ	48 (18-75)	3.3	30	491	5000	10000	86
AM20EWM-4805SH50NZ	48 (18-75)	5	30	491	4000	10000	87
AM20EWM-4812SH50NZ	48 (18-75)	12	10	491	1666	4700	87
AM20EWM-4815SH50NZ	48 (18-75)	15	10	491	1333	1600	88
AM20EWM-4824SH50NZ	48 (18-75)	24	10	491	833	470	89

Input Specification				
Parameters	Conditions	Typical	Maximum	Units
Input voltage	24VDC	9-36	40	VDC
	48VDC	18-75	80	
Input reflected ripple current		30		mA
Absolute maximum rating	24VDC, 1s max.	≥ -0.7	50	VDC
	48VDC, 1s max.	≥ -0.7	100	
Start-up voltage	24VDC		9	VDC
	48VDC		18	
Shut down voltage	24VDC	6.5		VDC
	48VDC	15.5		
On/Off Control	On - Ctrl pin open or apply 3.5-12V Off - Ctrl pin connect to GND or apply 0-1.2V; Idle current 8mA max.			

Isolation Specification				
Parameters	Conditions	Typical	Maximum	Units
Tested isolation voltage	Input / output 60 sec, ≤ 1mA	5000		VAC
Resistance	500VDC	≥10000		MΩ
Capacitance	100KHz, 0.1V	40		pF
Patient leakage current	240VAC/60Hz	3.6	5	μA
Insulation	Transformer creepage, clearance	≥8		mm

Output Specification					
Parameters	Conditions	Typical	Maximum	Units	
Voltage accuracy		±1	±2	%	
Line regulation	LL – HL 100% load	±0.2	±0.5	%	
Load regulation	5% - 100% load	±0.5	±1	%	
	0% - 5% load		±5	%	
Short circuit protection	Continues, Auto recovery				
Over current protection		180	260	% Io	
Over voltage protection		≥110	160	% Vo	
Transient Recovery Time	Nominal input, 25% load step change		300	500	µs
Transient Response Deviation*	Nominal input, 25% load step change	3.3V, 5V model	±5	±8	%
		others	±3	±5	
Ripple & Noise**	20MHz bandwidth	3.3V, 5V model	100	200	mV pk-pk
		AM20EWM-2415SH50NZ	80	150	
		AM20EWM-2424SH50NZ			
		AM20EWM-4824SH50NZ			
		AM20EWM-2412SH50NZ	50	100	
		AM20EWM-4812SH50NZ			
AM20EWM-4815SH50NZ					

*An 270µF electrolytic capacitor is required for 3.3V model.
**Ripple & noise is ±10% Vout max. for 3.3V, 5V model and 5% Vout max. for other models.

General Specifications				
Parameters	Conditions	Typical	Maximum	Units
Switching frequency*	100% Load	280		KHz
Operating temperature	With derating	-40 to +85		°C
Storage temperature		-55 to +125		°C
Manual soldering temperature	1.5mm distance from case ≤ 10s		300	°C
Wave soldering temperature	10s max.		260	°C
Temperature coefficient	100% Load		± 0.03	%/°C
Cooling	Free air convection			
Humidity	Non-condensing		95	% RH
Weight		27.0		g
Case material	Plastic (flammability to UL 94V-0)			
Dimensions (L x W x H)	2.03 x 1.04 x 0.47 inches (51.50 x 26.50 x 12.00 mm)			
Vibration	10-150Hz, 5G, 0.75mm, along all axis			
MTBF	> 1 000 000 hrs (MIL-HDBK -217F, t=+25°C)			

*Switching frequency reduces when load under 50%.
NOTE: All specifications in this datasheet are measured at an ambient temperature of 25°C, humidity<75%, nominal input voltage and at rated output load unless otherwise specified.

Safety Specifications

Parameters

Standards	Design to meet 2xMOPP EN60601-1 3rd, EN62368	
	EMI - Conducted and radiated emission	CISPR32/EN55032 Class A without additional components Class B with recommended EMC circuit 2-B (For AM20EWM-2412SH50NZ use recommended EMC circuit 1)
	Electrostatic Discharge Immunity	IEC/EN 61000-4-2, Contact $\pm 8\text{KV}$, Air $\pm 15\text{KV}$, Criteria B
	RF, Electromagnetic Field Immunity	IEC/EN 61000-4-3, 10V/m, Criteria A
	Electrical Fast Transient/Burst Immunity	IEC/EN 61000-4-4, 100KHz, $\pm 2\text{KV}$, with recommended EMC circuit 2-A, Criteria B
	Surge Immunity	IEC/EN 61000-4-5, L-L $\pm 2\text{KV}$ with recommended EMC circuit 2-A, Criteria B
	RF, Conducted Disturbance Immunity	IEC/EN 61000-4-6, 10Vr.m.s, Criteria A
	Power frequency Magnetic Field Immunity	IEC 61000-4-8: 30A/m, Continuous, Criteria A

Derating



AM20EWM-2403SH50NZ, AM20EWM-2405SH50NZ

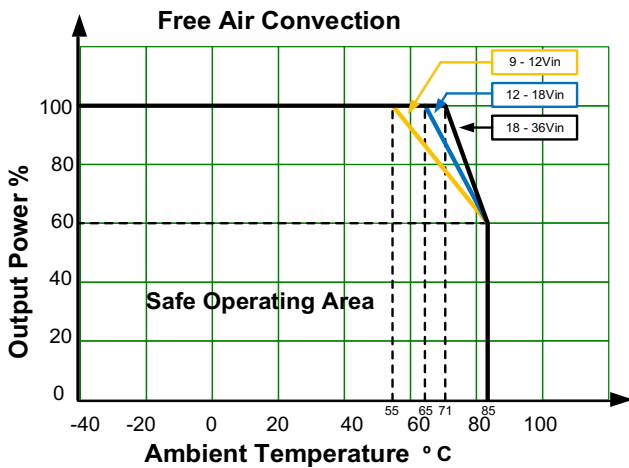

AM20EWM-4803SH50NZ, AM20EWM-4805SH50NZ

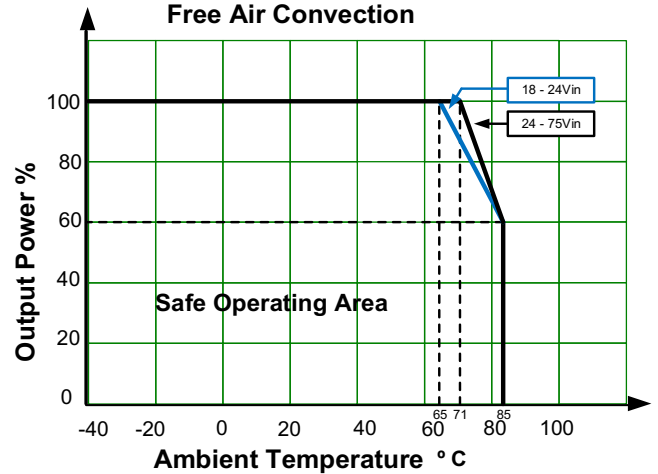

AM20EWM-2412SH50NZ, AM20EWM-2415SH50NZ

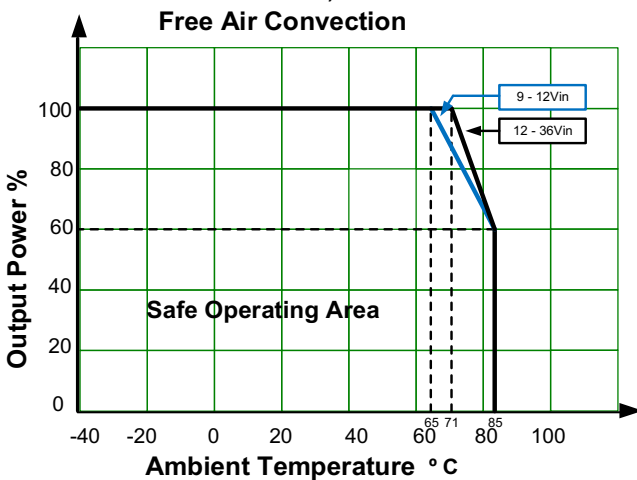

Other models

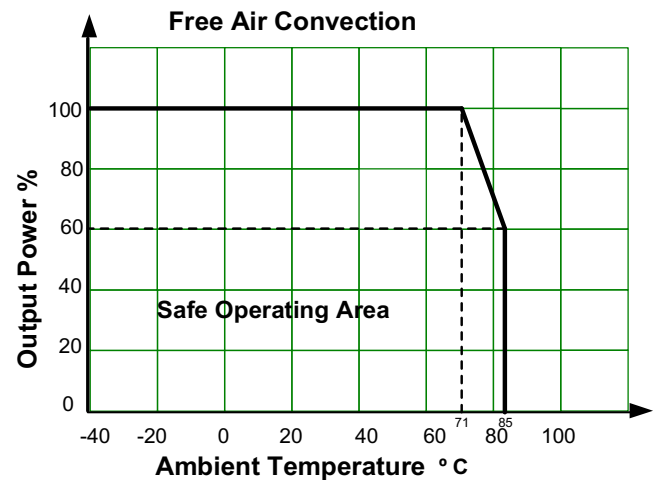

Typical Application Circuit

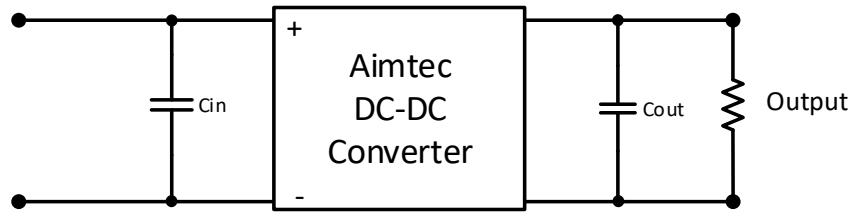

Vin	Cin	Cout	
		3.3Vout	Others
24V	100μF	270μF	10μF
48V	10 - 47μF	270μF	10μF

Recommended EMC Circuit 1

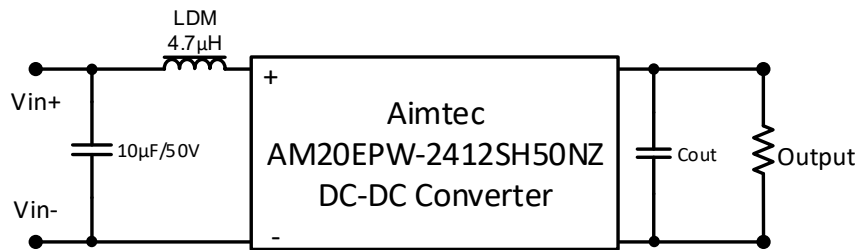

Recommended EMC Circuit 2

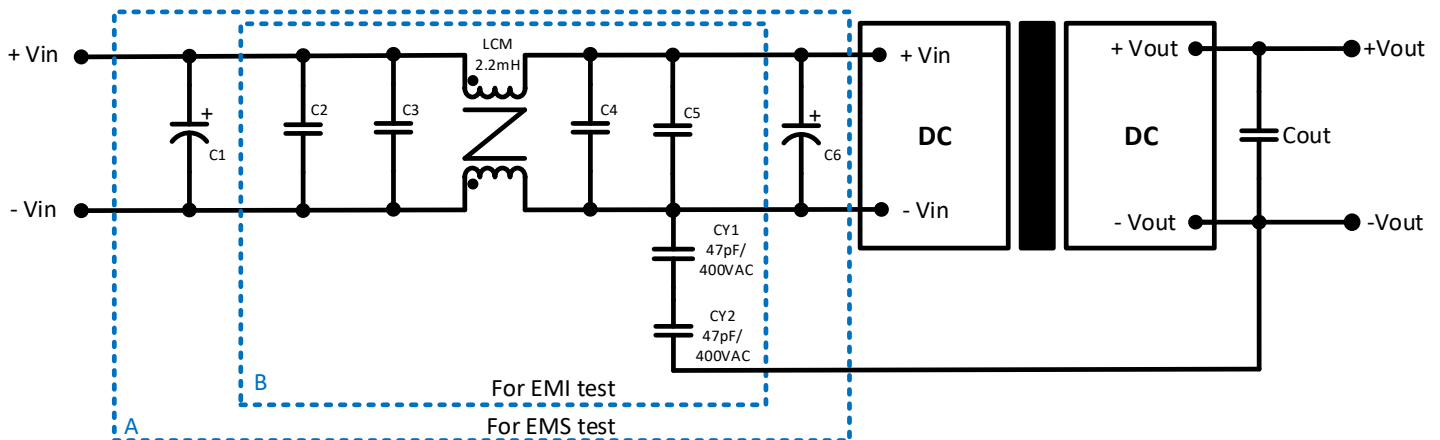

Notes: Part A for EMS filtering and Part B is used for EMI filtering.

	24Vin	48Vin
C1 / C6	680μF / 50V	330μF / 100V
C2 / C3 / C4 / C5	10μF / 50V	10μF / 100V
CY1 / CY2	3.3V / 5V output model required	

Dimensions

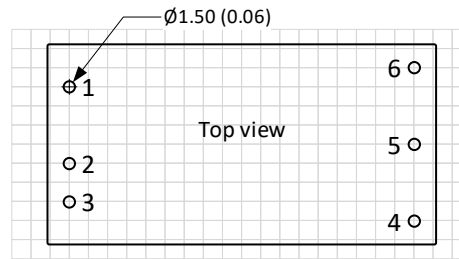
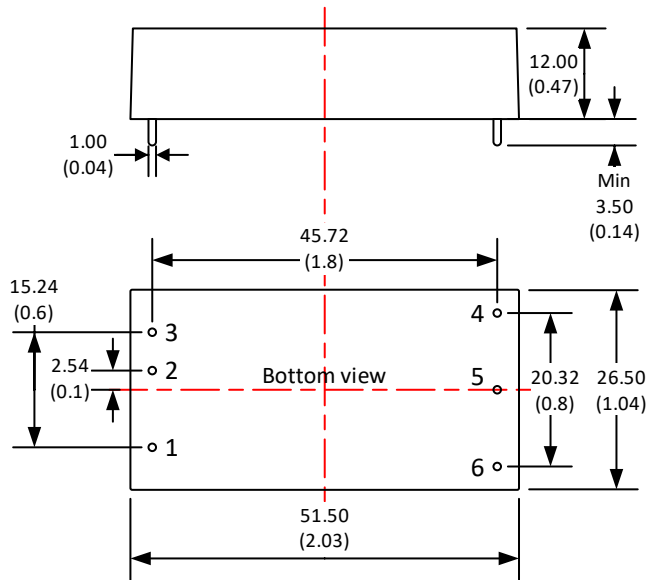

Note:
 Unit: mm (inch)
 Pin tolerance: ± 0.1 (0.004)
 General tolerance: ± 0.5 (0.02)

Pin Out Specifications	
Pin	Function
1	Ctrl
2	-V Input
3	+V Input
4	+V Output
5	-V Output
6	Trim

Trimming

Output voltage can be externally trimmed by utilizing the methods as shown below

Fixed Resistor

Variable Potentiometer

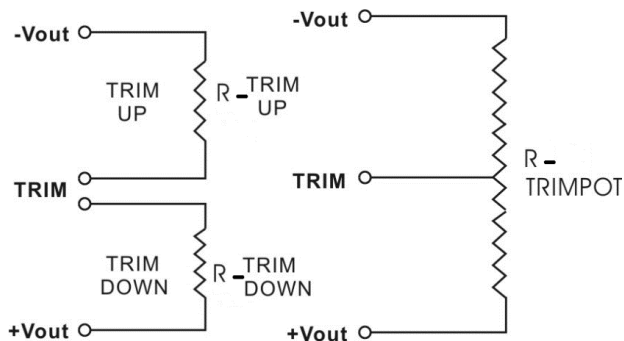

3.3V output models

Trim down %	1	2	3	4	5	6	7	8	9	10
Vout (VDC)	3.267	3.234	3.201	3.168	3.135	3.102	3.069	3.036	3.003	2.97
Rt down (K Ω)	195.744	109.218	73.096	53.27	40.741	32.108	25.797	20.983	17.19	14.124
Trim up %	1	2	3	4	5	6	7	8	9	10
Vout (VDC)	3.333	3.366	3.399	3.432	3.465	3.498	3.531	3.564	3.597	3.63
Rt up (K Ω)	308.349	105.149	60.286	40.58	29.504	22.407	17.472	13.842	11.058	8.857

5V output models

Trim down %	1	2	3	4	5	6	7	8	9	10
Vout (VDC)	4.95	4.9	4.85	4.8	4.75	4.7	4.65	4.6	4.55	4.5
Rt down (KΩ)	106.981	53.954	33.797	23.178	16.623	12.173	8.955	6.519	4.611	3.077
Trim up %	1	2	3	4	5	6	7	8	9	10
Vout (VDC)	5.05	5.1	5.15	5.2	5.25	5.3	5.35	5.4	5.45	5.5
Rt up (KΩ)	178.156	73.079	43.774	30	21.998	16.767	13.081	10.344	8.23	6.549

12V output models

Trim down %	1	2	3	4	5	6	7	8	9	10
Vout (VDC)	11.88	11.76	11.64	11.52	11.4	11.28	11.16	11.04	10.92	10.8
Rt down (KΩ)	819.546	401.372	259.971	188.888	146.115	117.548	97.118	81.781	69.845	60.29
Trim up %	1	2	3	4	5	6	7	8	9	10
Vout (VDC)	12.12	12.24	12.36	12.48	12.6	12.72	12.84	12.96	13.08	13.2
Rt up (KΩ)	217.33	99.886	61.311	42.129	30.653	23.016	17.569	13.486	10.314	7.777

15V output models

Trim down %	1	2	3	4	5	6	7	8	9	10
Vout (VDC)	14.85	14.7	14.55	14.4	14.25	14.1	13.95	13.8	13.65	13.5
Rt down (KΩ)	1139.984	562.028	366.415	268.044	208.839	169.294	141.009	119.775	103.248	90.019
Trim up %	1	2	3	4	5	6	7	8	9	10
Vout (VDC)	15.15	15.3	15.45	15.6	15.75	15.9	16.05	16.2	16.35	16.5
Rt up (KΩ)	229.923	106.022	65.367	45.158	33.07	25.027	19.29	14.991	11.65	8.979

24V output models

Trim down %	1	2	3	4	5	6	7	8	9	10
Vout (VDC)	23.76	23.52	23.28	23.04	22.8	22.56	22.32	22.08	21.84	21.6
Rt down (KΩ)	1641.145	916.523	628.023	472.994	376.213	310.045	261.948	225.408	196.708	173.567
Trim up %	1	2	3	4	5	6	7	8	9	10
Vout (VDC)	24.24	24.48	24.72	24.96	25.2	25.44	25.68	25.92	26.16	26.4
Rt up (KΩ)	363.754	136.467	78.989	52.775	37.771	28.052	21.245	16.211	12.337	9.264

NOTE: 1. Datasheets are updated as needed and as such, specifications are subject to change without notice. Once printed or downloaded, datasheets are no longer controlled by Aimtec; refer to www.aimtec.com for the most current product specifications. **2.** Product labels shown, including safety agency certifications on labels, may vary based on the date manufactured. **3.** Mechanical drawings and specifications are for reference only. **4.** All specifications are measured at an ambient temperature of 25°C, humidity<75%, nominal input voltage and at rated output load unless otherwise specified. **5.** Aimtec may not have conducted destructive testing or chemical analysis on all internal components and chemicals at the time of publishing this document. CAS numbers and other limited information are considered proprietary and may not be available for release. **6.** This product is not designed for use in critical life support systems, equipment used in hazardous environments, nuclear control systems or other such applications which necessitate specific safety and regulatory standards other the ones listed in this datasheet. **7.** Warranty is in accordance with Aimtec's standard Terms of Sale available at www.aimtec.com.