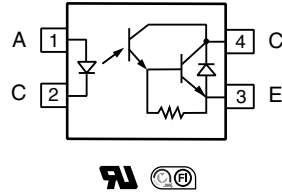


Optocoupler, Photodarlington Output, High Gain, 300 V BV_{CEO}



FEATURES

- High collector emitter voltage, $V_{CEO} = 300\text{ V}$
- Low coupling capacitance
- High common mode transient immunity
- Isolation rated voltage 5000 V_{RMS}
- Standard plastic DIP-4 package
- Material categorization:
for definitions of compliance please see www.vishay.com/doc?99912



APPLICATIONS

- Telecom
- Industrial controls
- Battery powered equipment
- Office machines
- Programmable controllers

DESIGN SUPPORT TOOLS AVAILABLE



DESCRIPTION

The SFH619A has a GaAs infrared emitting diode emitter, which is optically coupled to a silicon photodarlington detector, and is incorporated in a plastic DIP-4 package.

It features a high current transfer ratio, low coupling capacitance, and high isolation voltage.

The coupling device is designed for signal transmission between two electrically separated circuits.

AGENCY APPROVALS

- [UL](#)
- [cUL](#)
- [CQC](#)

ORDERING INFORMATION												
S	F	H	6	1	9	A	-	X	0	0	#	T
PART NUMBER							PACKAGE OPTION			TAPE AND REEL		
AGENCY CERTIFIED / PACKAGE							CTR (%)					
UL, BSI, FIMKO							≥ 1000					
DIP-4							SFH619A					
SMD-4, option 7							SFH619A-X007T ⁽¹⁾					
SMD-4, option 9							SFH619A-X009T ⁽¹⁾					

Notes

- Additional options may be possible, please contact sales office
- ⁽¹⁾ Also available in tubes; do not put T on the end



ABSOLUTE MAXIMUM RATINGS (T _{amb} = 25 °C, unless otherwise specified)				
PARAMETER	TEST CONDITION	SYMBOL	VALUE	UNIT
INPUT				
Reverse voltage		V _R	6	V
Forward current		I _F	50	mA
Power dissipation		P _{diss}	70	mW
OUTPUT				
Collector emitter voltage		V _{CEO}	300	V
Emitter collector voltage		V _{ECO}	0.3	V
Collector current		I _C	125	mA
Power dissipation		P _{diss}	150	mW
COUPLER				
Total power dissipation		P _{tot}	200	mW
Storage temperature		T _{stg}	-55 to +125	°C
Operating temperature		T _{amb}	-55 to +100	°C
Soldering temperature	t = 10 s	T _{slid}	260	°C

Note

- Stresses in excess of the absolute maximum ratings can cause permanent damage to the device. Functional operation of the device is not implied at these or any other conditions in excess of those given in the operational sections of this document. Exposure to absolute maximum ratings for extended periods of the time can adversely affect reliability

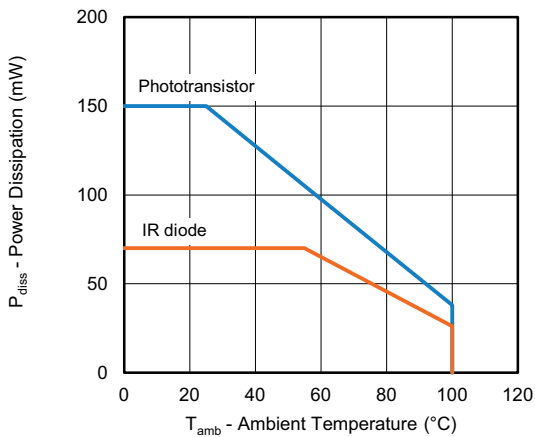


Fig. 1 - Power Dissipation vs. Ambient Temperature

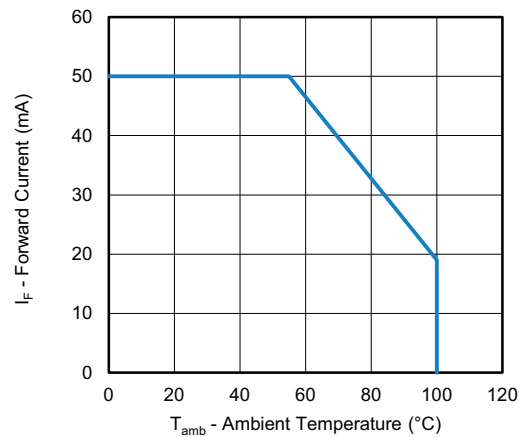


Fig. 2 - Maximum Forward Current vs. Ambient Temperature

ELECTRICAL CHARACTERISTICS ($T_{amb} = 25\text{ }^{\circ}\text{C}$, unless otherwise specified)						
PARAMETER	TEST CONDITION	SYMBOL	MIN.	TYP.	MAX.	UNIT
INPUT						
Forward voltage	$I_F = 10\text{ mA}$	V_F	-	1.2	1.5	V
Reverse current	$V_R = 6\text{ V}$	I_R	-	0.02	10	μA
Capacitance	$V_R = 0\text{ V}$	C_I	-	30	-	pF
OUTPUT						
Collector emitter breakdown voltage	$I_{CE} = 100\text{ }\mu\text{A}$	BV_{CEO}	300	-	-	V
Emitter collector breakdown voltage	$I_{EC} = 100\text{ }\mu\text{A}$	BV_{ECO}	0.3	-	-	V
Collector emitter leakage current	$V_{CE} = 200\text{ V}, T_{amb} = 25\text{ }^{\circ}\text{C}$	I_{CEO}	-	10	200	nA
	$V_{CE} = 200\text{ V}, T_{amb} = 100\text{ }^{\circ}\text{C}$	I_{CEO}	-	-	20	μA
COUPLER						
Collector emitter saturation voltage	$I_F = 1\text{ mA}, I_C = 10\text{ mA}$	V_{CEsat}	-	-	1	V
Coupling capacitance	$V_{I-O} = 0\text{ V}, f = 1\text{ MHz}$	$C_{I/O}$	-	0.6	-	pF

Note

- Minimum and maximum values are testing requirements. Typical values are characteristics of the device and are the result of engineering evaluation. Typical values are for information only and are not part of the testing requirements

CURRENT TRANSFER RATIO						
PARAMETER	TEST CONDITION	SYMBOL	MIN.	TYP.	MAX.	UNIT
I_C/I_F	$I_F = 1\text{ mA}, V_{CE} = 1\text{ V}$	CTR	1000	-	-	%

SWITCHING CHARACTERISTICS						
PARAMETER	TEST CONDITION	SYMBOL	MIN.	TYP.	MAX.	UNIT
Turn-on time	$V_{CC} = 10\text{ V}, I_F = 5\text{ mA}, R_L = 100\text{ }\Omega$	t_{on}	-	6.5	-	μs
Turn-off time	$V_{CC} = 10\text{ V}, I_F = 5\text{ mA}, R_L = 100\text{ }\Omega$	t_{off}	-	72	-	μs

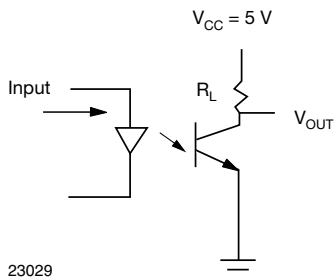


Fig. 3 - Test Circuit for Switching Characteristics

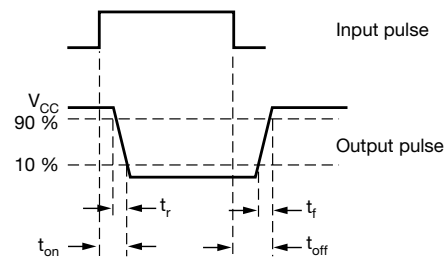


Fig. 4 - Parameter and Limit Definition

SAFETY AND INSULATION RATINGS				
PARAMETER	TEST CONDITION	SYMBOL	VALUE	UNIT
Climatic classification	According to IEC 68 part 1		55 / 115 / 21	
Pollution degree	According to DIN VDE 0109		2	
Comparative tracking index	Insulation group IIIa	CTI	175	
Maximum rated withstanding isolation voltage	According to UL1577, t = 1 min	V_{ISO}	5000	V_{RMS}
Maximum transient isolation voltage	According to DIN EN 60747-5-5	V_{IOTM}	8000	V_{peak}
Maximum repetitive peak isolation voltage	According to DIN EN 60747-5-5	V_{IORM}	890	V_{peak}
Isolation resistance	$V_{IO} = 500\text{ V}, T_{amb} = 25\text{ }^{\circ}\text{C}$	R_{IO}	$\geq 10^{12}$	Ω
	$V_{IO} = 500\text{ V}, T_{amb} = 100\text{ }^{\circ}\text{C}$	R_{IO}	$\geq 10^{11}$	Ω
Output safety power		P_{SO}	700	mW
Input safety current		I_{SI}	400	mA
Input safety temperature		T_S	175	$^{\circ}\text{C}$
Creepage distance			≥ 7	mm
Clearance distance			≥ 7	mm
Insulation thickness		DTI	≥ 0.4	mm

Note

- As per IEC 60747-5-5, § 7.4.3.8.2, this optocoupler is suitable for “safe electrical insulation” only within the safety ratings. Compliance with the safety ratings shall be ensured by means of protective circuits.

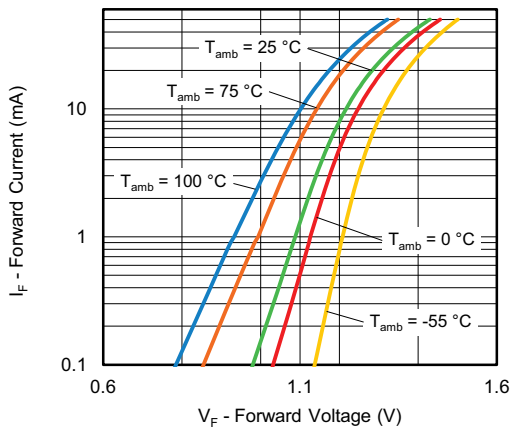
TYPICAL CHARACTERISTICS ($T_{amb} = 25\text{ }^{\circ}\text{C}$, unless otherwise specified)


Fig. 5 - Forward Current vs. Forward Voltage

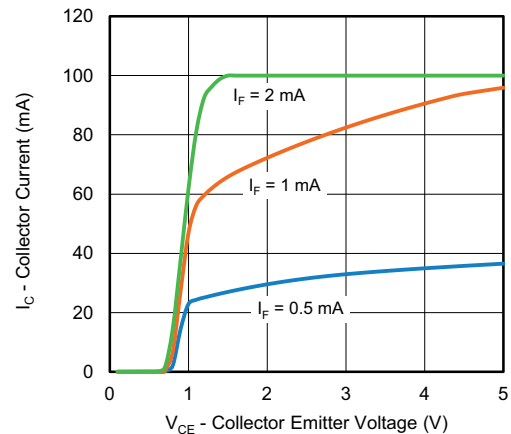


Fig. 6 - Collector Current vs. Collector Emitter Voltage (non-saturated)

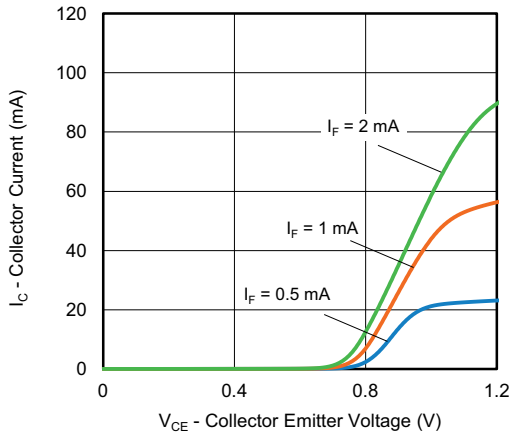


Fig. 7 - Collector Current vs. Collector Emitter Voltage (saturated)

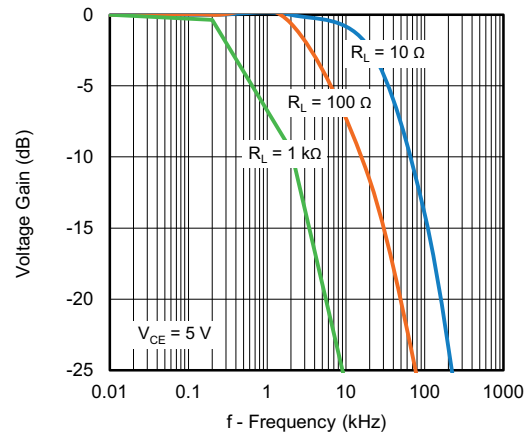


Fig. 10 - Voltage Gain vs. Frequency

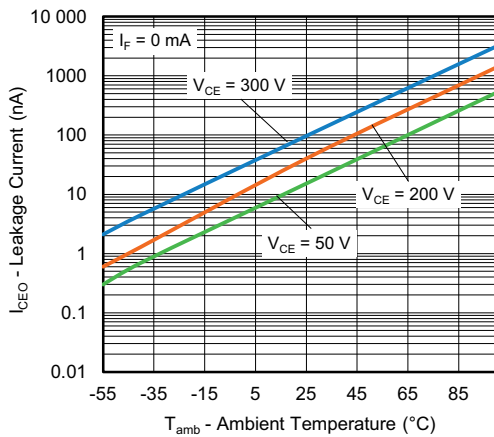


Fig. 8 - Leakage Current vs. Ambient Temperature

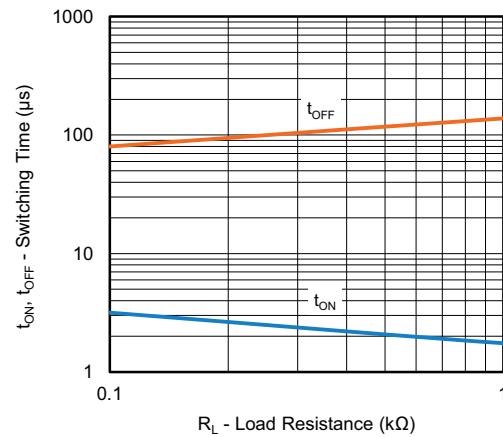


Fig. 11 - Switching Time vs. Load Resistance

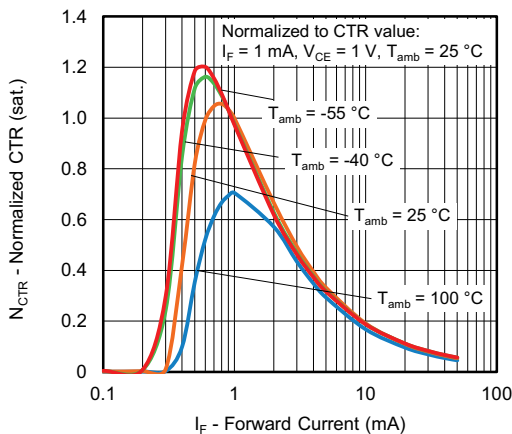
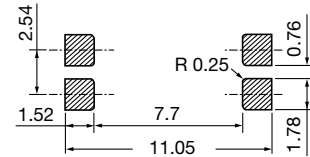
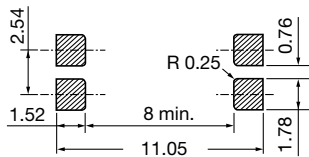
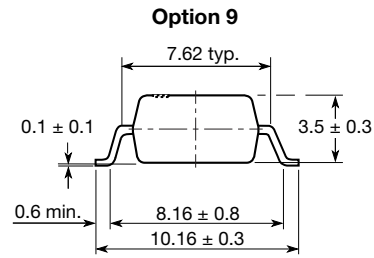
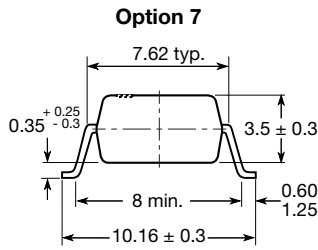
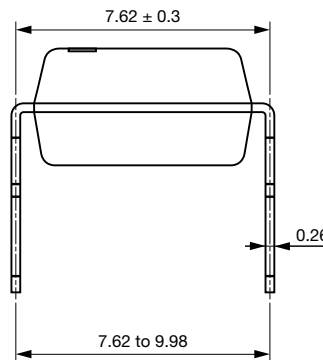
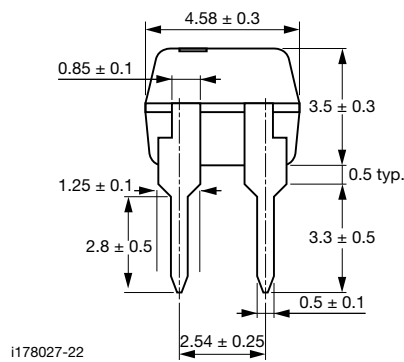
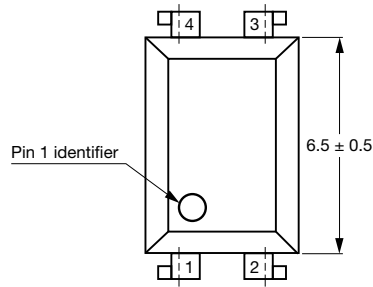


Fig. 9 - Normalized CTR vs. Forward Current



PACKAGE DIMENSIONS in millimeters

4 Pin Package



20802-51

PACKAGE MARKING



Fig. 12 - Example of SFH619A

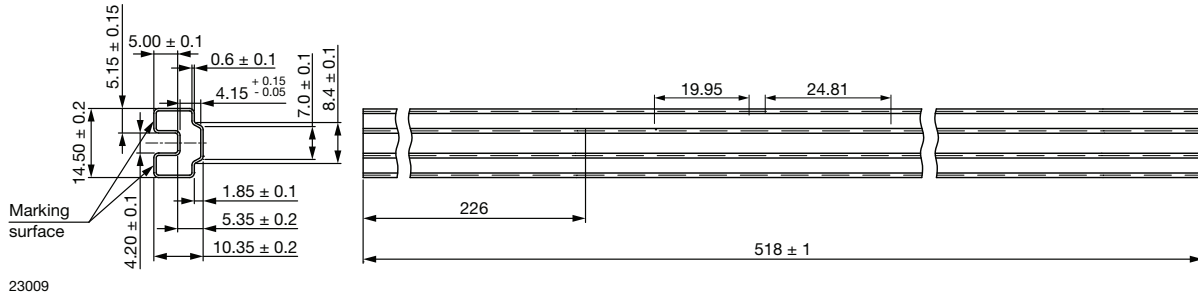
Note

- Tape and reel suffix (T) is not part of the package marking

PACKAGING INFORMATION

DEVICES PER TUBE			
TYPE	UNITS/TUBE	TUBES/BOX	UNITS/BOX
DIP-4	100	40	4000
SMD-4, option 7	100	40	4000
SMD-4, option 9	100	40	4000

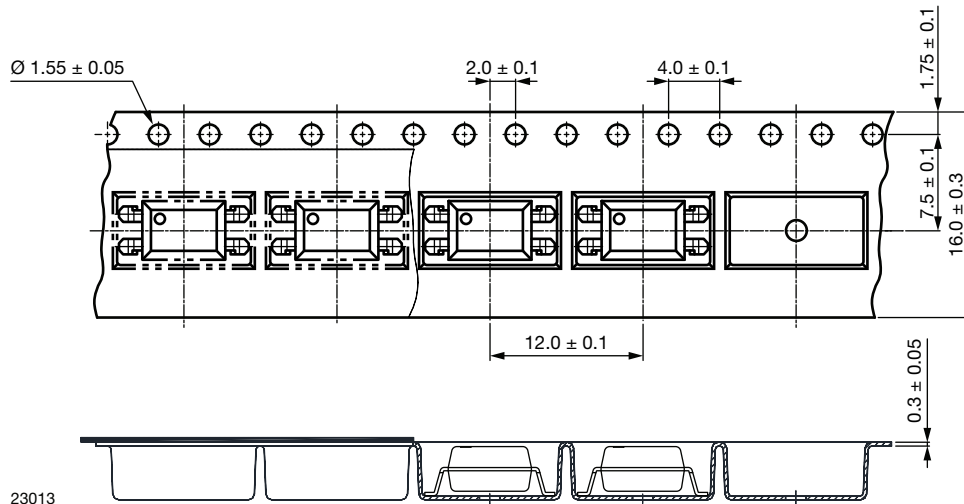
DIP-4 Tube



23009

Fig. 13 - Tube

SMD-4 Tape



23013

Fig. 14 - Tape and Reel Packaging (1000 pieces on reel)

Reel


Fig. 15 - Tape and Reel Shipping Medium

SOLDER PROFILES
IR Reflow Soldering (JEDEC® J-STD-020C compliant)

One time soldering reflow is recommended within the condition of temperature and time profile shown below. Do not solder more than three times.

PROFILE ITEM	CONDITIONS
Preheat	
- Temperature minimum ($T_{S \text{ min.}}$)	150 °C
- Temperature maximum ($T_{S \text{ max.}}$)	200 °C
- Time (min. to max.) (t_S)	90 s ± 30 s
Soldering zone	
- Temperature (T_L)	217 °C
- Time (t_L)	60 s
Peak temperature (T_p)	260 °C
Ramp-up rate	3 °C/s max.
Ramp-down rate	3 °C/s to 6 °C/s

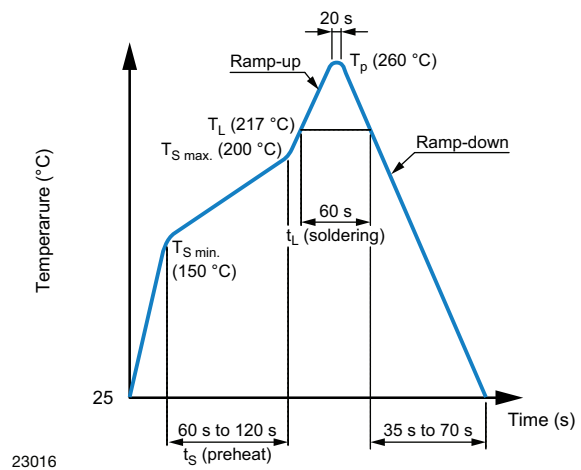


Fig. 16



Wave Soldering (JEDEC JESD22-A111 compliant)

One time soldering is recommended within the condition of temperature.

Temperature: 260 °C + 0 °C / - 5 °C

Time: 10 s

Preheat temperature: 25 °C to 140 °C

Preheat time: 30 s to 80 s

Hand Soldering by Soldering Iron

Allow single lead soldering in every single process. One time soldering is recommended.

Temperature: 380 °C + 0 °C / - 5 °C

Time: 3 s max.



Fig. 17

23017



Disclaimer

ALL PRODUCT, PRODUCT SPECIFICATIONS AND DATA ARE SUBJECT TO CHANGE WITHOUT NOTICE TO IMPROVE RELIABILITY, FUNCTION OR DESIGN OR OTHERWISE.

Vishay Intertechnology, Inc., its affiliates, agents, and employees, and all persons acting on its or their behalf (collectively, "Vishay"), disclaim any and all liability for any errors, inaccuracies or incompleteness contained in any datasheet or in any other disclosure relating to any product.

Vishay makes no warranty, representation or guarantee regarding the suitability of the products for any particular purpose or the continuing production of any product. To the maximum extent permitted by applicable law, Vishay disclaims (i) any and all liability arising out of the application or use of any product, (ii) any and all liability, including without limitation special, consequential or incidental damages, and (iii) any and all implied warranties, including warranties of fitness for particular purpose, non-infringement and merchantability.

Statements regarding the suitability of products for certain types of applications are based on Vishay's knowledge of typical requirements that are often placed on Vishay products in generic applications. Such statements are not binding statements about the suitability of products for a particular application. It is the customer's responsibility to validate that a particular product with the properties described in the product specification is suitable for use in a particular application. Parameters provided in datasheets and / or specifications may vary in different applications and performance may vary over time. All operating parameters, including typical parameters, must be validated for each customer application by the customer's technical experts. Product specifications do not expand or otherwise modify Vishay's terms and conditions of purchase, including but not limited to the warranty expressed therein.

Except as expressly indicated in writing, Vishay products are not designed for use in medical, life-saving, or life-sustaining applications or for any other application in which the failure of the Vishay product could result in personal injury or death. Customers using or selling Vishay products not expressly indicated for use in such applications do so at their own risk. Please contact authorized Vishay personnel to obtain written terms and conditions regarding products designed for such applications.

No license, express or implied, by estoppel or otherwise, to any intellectual property rights is granted by this document or by any conduct of Vishay. Product names and markings noted herein may be trademarks of their respective owners.