

SFH 4546

Radial T1 3/4

High Power Infrared Emitter (940 nm)



Applications

- Electronic Equipment
- Industrial Automation (Machine controls, Light barriers, Vision controls)
- Safety systems and CCTV
- Smoke Detectors

Features:

- Package: black epoxy
- ESD: 2 kV acc. to ANSI/ESDA/JEDEC JS-001 (HBM, Class 2)
- High Power Infrared LED
- Short switching times

Ordering Information

Type	Radiant intensity ¹⁾ $I_F = 100 \text{ mA}; t_p = 20 \text{ ms}$ I_e	Radiant intensity ¹⁾ typ. $I_F = 100 \text{ mA}; t_p = 20 \text{ ms}$ I_e	Ordering Code
SFH 4546	63 ... 320 mW/sr	130 mW/sr	Q65110A8096
SFH 4546-AWBW	100 ... 320 mW/sr	130 mW/sr	Q65110A9615

Maximum Ratings

$T_A = 25\text{ °C}$

Parameter	Symbol		Values
Operating temperature	T_{op}	min. max.	-40 °C 100 °C
Storage temperature	T_{stg}	min. max.	-40 °C 100 °C
Reverse voltage ²⁾	V_R	max.	12 V
Forward current	I_F	max.	100 mA
Surge current $t_p \leq 100\ \mu\text{s}; D = 0$	I_{FSM}	max.	1 A
Power consumption	P_{tot}	max.	180 mW
ESD withstand voltage acc. to ANSI/ESDA/JEDEC JS-001 (HBM, Class 2)	V_{ESD}	max.	2 kV

Characteristics

$I_F = 100 \text{ mA}$; $t_p = 20 \text{ ms}$; $T_A = 25 \text{ °C}$

Parameter	Symbol		Values
Peak wavelength	λ_{peak}	typ.	950 nm
Centroid wavelength	$\lambda_{\text{centroid}}$	typ.	940 nm
Spectral bandwidth at 50% $I_{\text{rel,max}}$	$\Delta\lambda$	typ.	42 nm
Half angle	φ	typ.	20 °
Dimensions of active chip area	L x W	typ.	0.3 x 0.3 mm x mm
Rise time (10% / 90%) $I_F = 100 \text{ mA}$; $R_L = 50 \text{ }\Omega$	t_r	typ.	12 ns
Fall time (10% / 90%) $I_F = 100 \text{ mA}$; $R_L = 50 \text{ }\Omega$	t_f	typ.	12 ns
Forward voltage	V_F	typ. max.	1.5 V 1.8 V
Forward voltage $I_F = 1 \text{ A}$; $t_p = 100 \text{ }\mu\text{s}$	V_F	typ. max.	2.3 V 3 V
Reverse current ²⁾ $V_R = 5 \text{ V}$	I_R	max. typ.	10 μA 0.01 μA
Total radiant flux ³⁾	Φ_e	typ.	55 mW
Radiant intensity ¹⁾ $I_F = 1 \text{ A}$; $t_p = 25 \text{ }\mu\text{s}$	I_e	typ.	1000 mW/sr
Temperature coefficient of brightness	TC_I	typ.	-0.5 % / K
Temperature coefficient of voltage	TC_V	typ.	-1.3 mV / K
Temperature coefficient of wavelength	TC_λ	typ.	0.3 nm / K
Thermal resistance junction ambient real ⁴⁾	R_{thJA}	max.	450 K / W

Brightness Groups

$T_A = 25\text{ °C}$

Group	Radiant intensity	Radiant intensity
	$I_F = 100\text{ mA}; t_p = 20\text{ ms}$ min. I_e	$I_F = 100\text{ mA}; t_p = 20\text{ ms}$ max. I_e
V	63 mW/sr	125 mW/sr
AW	100 mW/sr	200 mW/sr
BW	160 mW/sr	320 mW/sr

Only one group in one packing unit (variation lower 2:1).

Relative Spectral Emission ^{5), 6)}

$I_{rel} = f(\lambda); I_F = 100\text{ mA}; t_p = 20\text{ ms}$

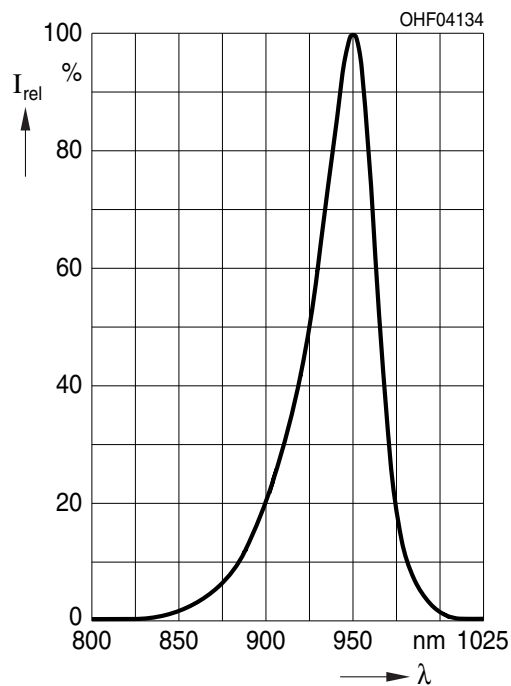

Radiation Characteristics 5), 6)

$I_{rel} = f(\varphi)$

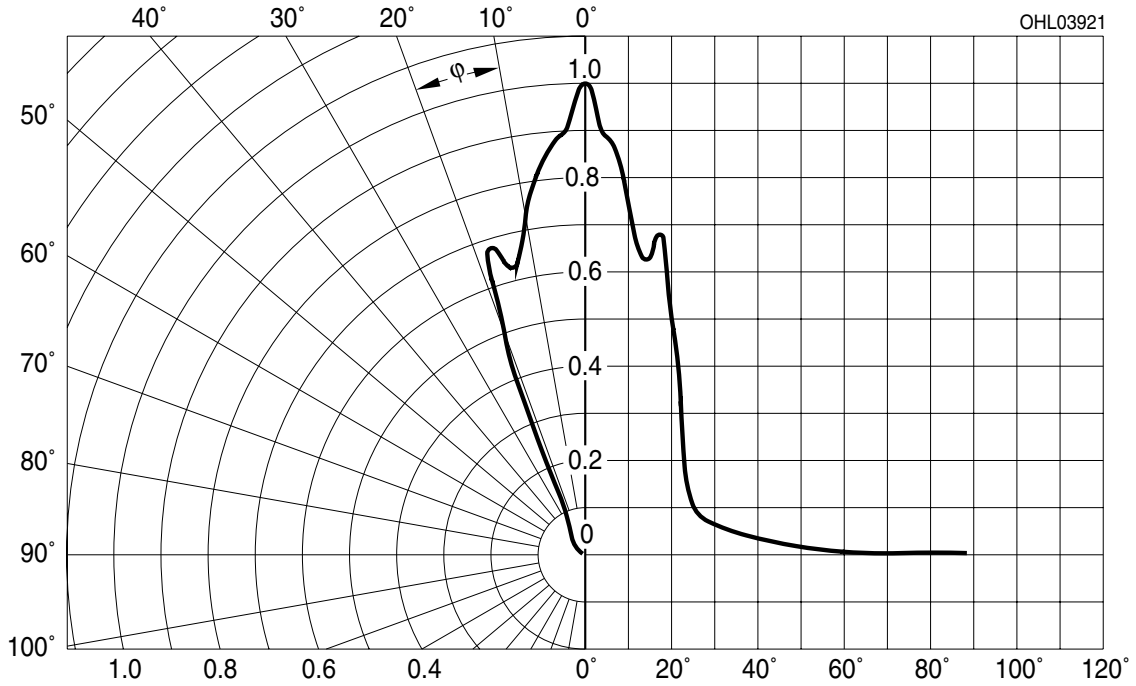

Forward current 5), 6)

$I_F = f(V_F)$; single pulse; $t_p = 100 \mu s$

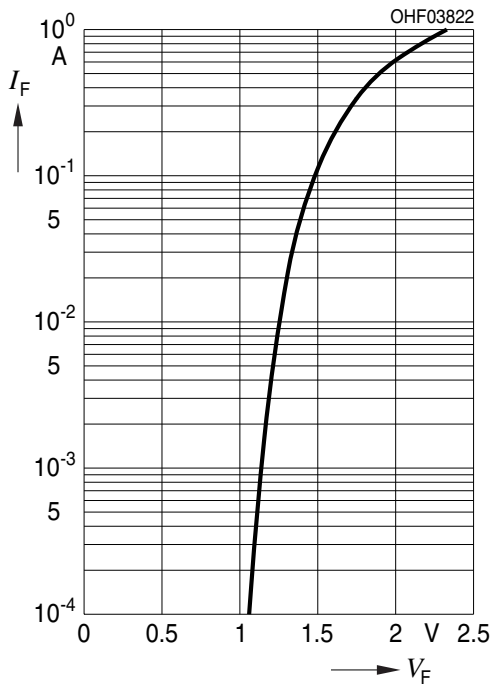

Relative Radiant Intensity 5), 6)

$I_e/I_e(100mA) = f(I_F)$; single pulse; $t_p = 25 \mu s$

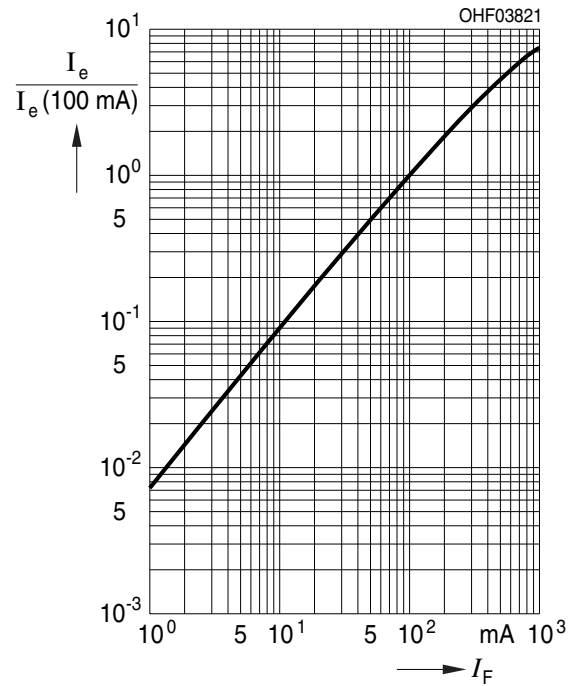

Max. Permissible Forward Current

$I_{F,max} = f(T_A); R_{thJA} = 450 \text{ K/W}$

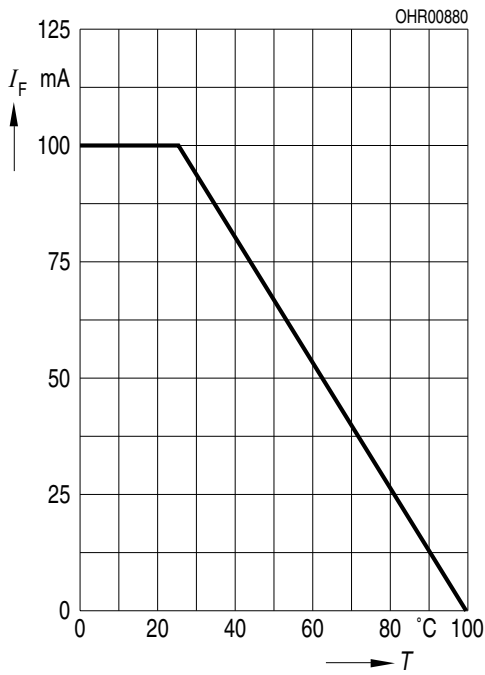

Permissible Pulse Handling Capability

$I_F = f(t_p); \text{duty cycle } D = \text{parameter}; T_A = 25^\circ\text{C}$

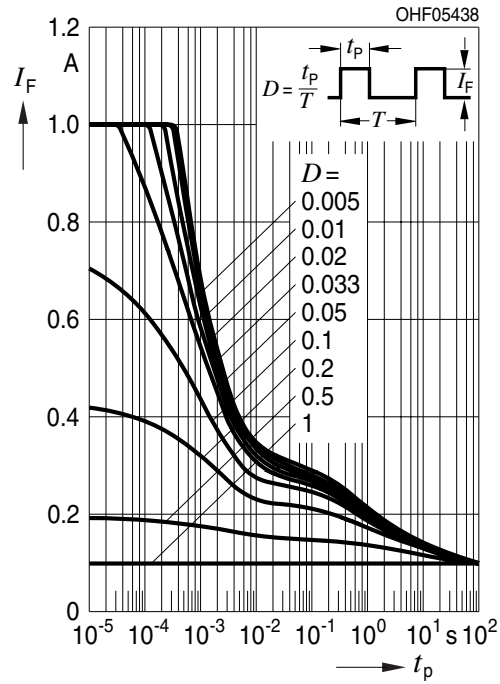

Permissible Pulse Handling Capability

$I_F = f(t_p); \text{duty cycle } D = \text{parameter}; T_A = 85^\circ\text{C}$

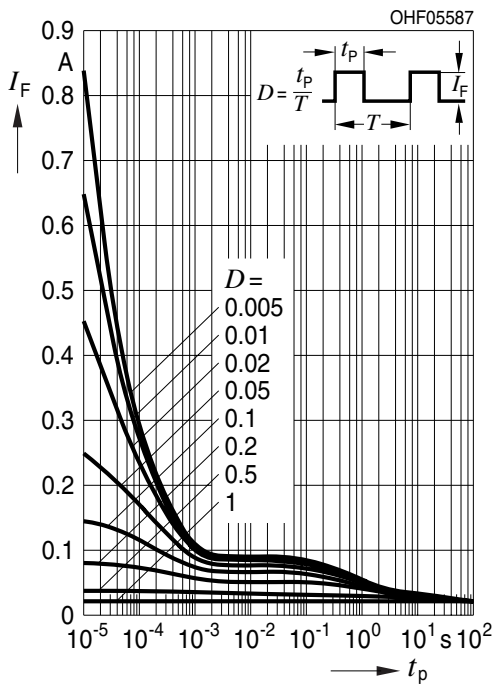

Recommended Solder Pad ⁷⁾

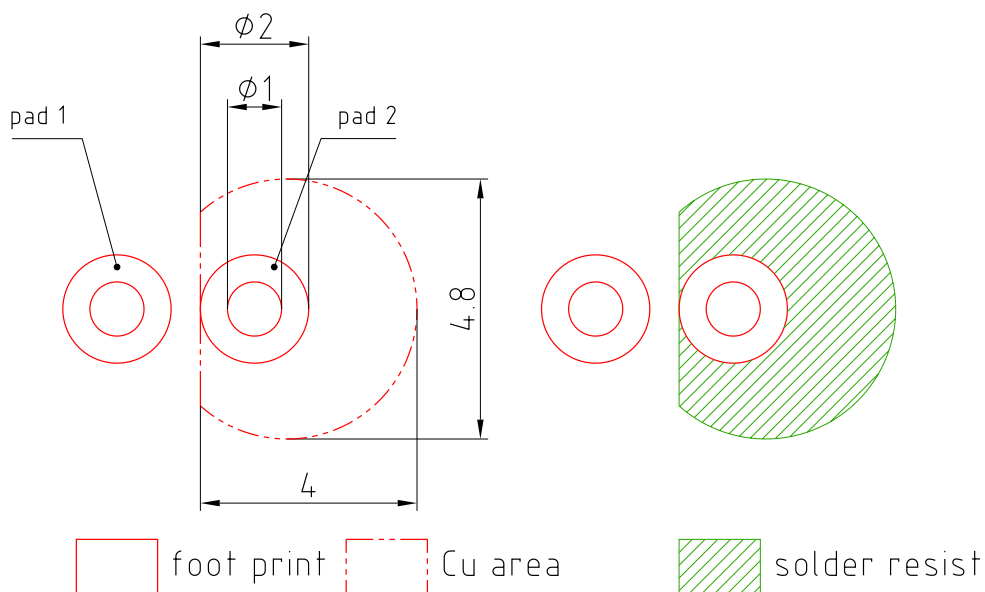

E062.3010.188-01

Pad 1: cathode

TTW Soldering

IEC-61760-1 TTW

OHA04645

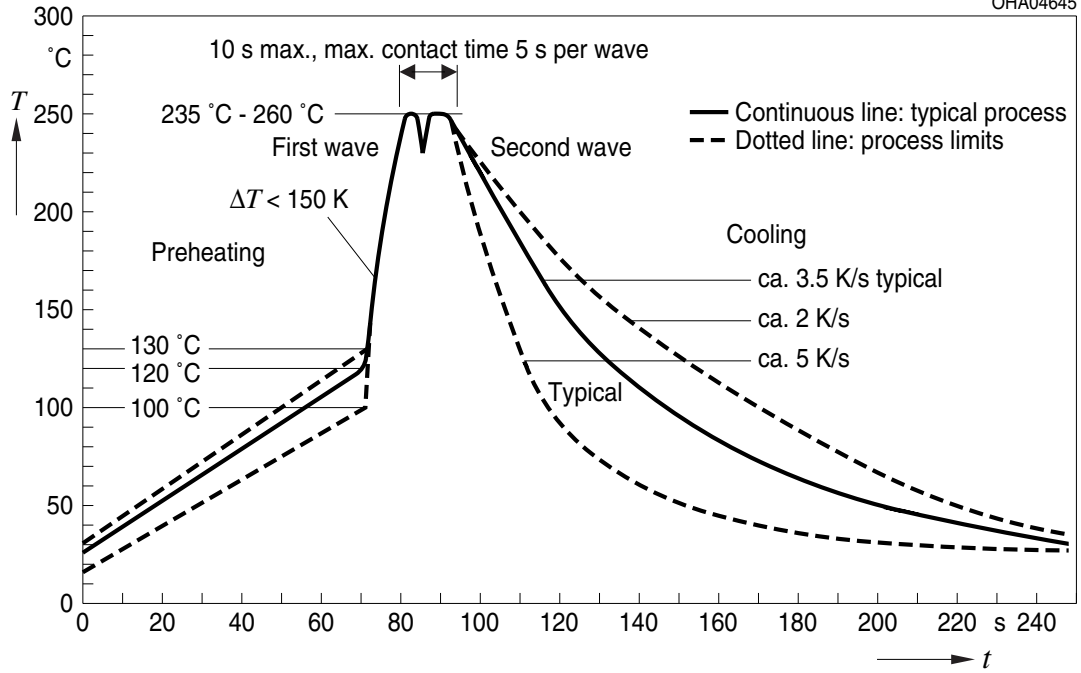

Notes

The evaluation of eye safety occurs according to the standard IEC 62471:2006 (photo biological safety of lamps and lamp systems). Within the risk grouping system of this IEC standard, the LED specified in this data sheet falls into the class **exempt group (exposure time 10000 s)**. Under real circumstances (for exposure time, conditions of the eye pupils, observation distance), it is assumed that no endangerment to the eye exists from these devices. As a matter of principle, however, it should be mentioned that intense light sources have a high secondary exposure potential due to their blinding effect. When looking at bright light sources (e.g. headlights), temporary reduction in visual acuity and afterimages can occur, leading to irritation, annoyance, visual impairment, and even accidents, depending on the situation.

Packing information is available on the internet (online product catalog).

For further application related informations please visit www.osram-os.com/appnotes

Disclaimer

Disclaimer

Language english will prevail in case of any discrepancies or deviations between the two language wordings.

Attention please!

The information describes the type of component and shall not be considered as assured characteristics. Terms of delivery and rights to change design reserved. Due to technical requirements components may contain dangerous substances.

For information on the types in question please contact our Sales Organization.

If printed or downloaded, please find the latest version in the OSRAM OS Webside.

Packing

Please use the recycling operators known to you. We can also help you – get in touch with your nearest sales office.

By agreement we will take packing material back, if it is sorted. You must bear the costs of transport. For packing material that is returned to us unsorted or which we are not obliged to accept, we shall have to invoice you for any costs incurred.

Product safety devices/applications or medical devices/applications

OSRAM OS components are not developed, constructed or tested for the application as safety relevant component or for the application in medical devices.

In case Buyer – or Customer supplied by Buyer– considers using OSRAM OS components in product safety devices/applications or medical devices/applications, Buyer and/or Customer has to inform the local sales partner of OSRAM OS immediately and OSRAM OS and Buyer and /or Customer will analyze and coordinate the customer-specific request between OSRAM OS and Buyer and/or Customer.

Glossary

- 1) **Radiant intensity:** Measured at a solid angle of $\Omega = 0.01$ sr
- 2) **Reverse Operation:** Reverse Operation of 10 hours is permissible in total. Continuous reverse operation is not allowed.
- 3) **Total radiant flux:** Measured with integrating sphere.
- 4) **Thermal resistance:** junction - ambient, mounted on PC-board (FR4), padsize 16 mm² each
- 5) **Typical Values:** Due to the special conditions of the manufacturing processes of LED, the typical data or calculated correlations of technical parameters can only reflect statistical figures. These do not necessarily correspond to the actual parameters of each single product, which could differ from the typical data and calculated correlations or the typical characteristic line. If requested, e.g. because of technical improvements, these typ. data will be changed without any further notice.
- 6) **Testing temperature:** $T_A = 25^\circ\text{C}$
- 7) **Tolerance of Measure:** Unless otherwise noted in drawing, tolerances are specified with ± 0.1 and dimensions are specified in mm.

Published by OSRAM Opto Semiconductors GmbH
Leibnizstraße 4, D-93055 Regensburg
www.osram-os.com © All Rights Reserved.

EU RoHS and China RoHS compliant product



此产品符合欧盟 RoHS 指令的要求；
按照中国的相关法规和标准，不含有毒有害物质或元素。