

4

3

2

1

THIS DRAWING IS UNPUBLISHED.

RELEASED FOR PUBLICATION

© COPYRIGHT BY TYCO ELECTRONICS CORPORATION.

ALL RIGHTS RESERVED.

LOC FB DIST 00

REVISIONS

P	LTR	DESCRIPTION	DATE	DWN	APVD
0	RELEASED	FB00-0013-03	23JAN03	J.J	T.S

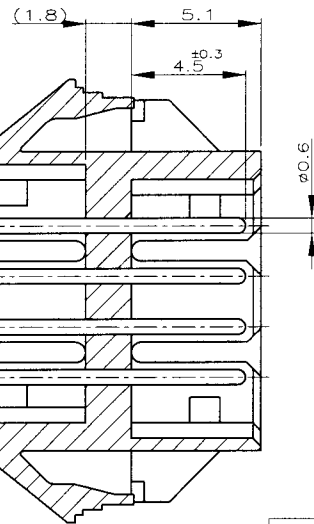
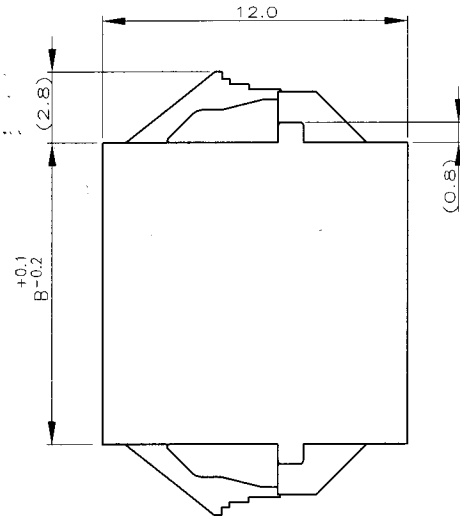
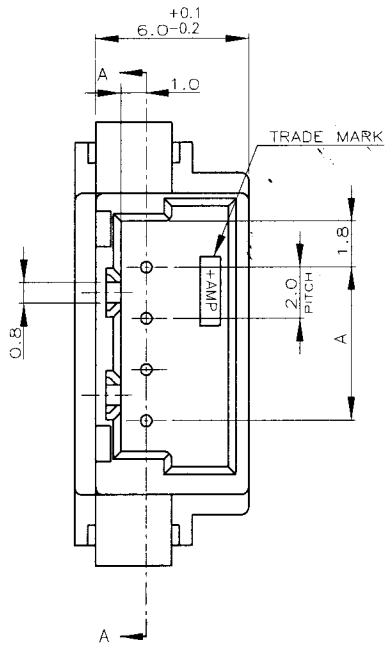

SECT. A-A

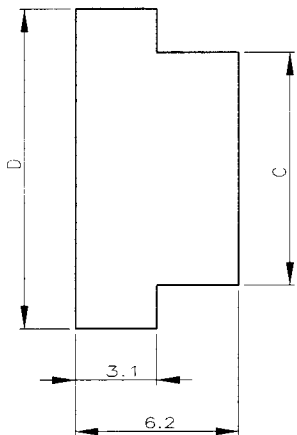

PANEL CUTOUT DIMENSION (TOLERANCE:±0.1)  
(RECOMMENDED PANE THICKNESS:0.8mm ~ 1.6mm)

TOLERANCES UNLESS OTHERWISE SPECIFIED:

- 10 > \* : ±0.2
- 30 > \* > 10 : ±0.25
- 100 > \* > 30 : ±0.3
- ANGLE : ±3°

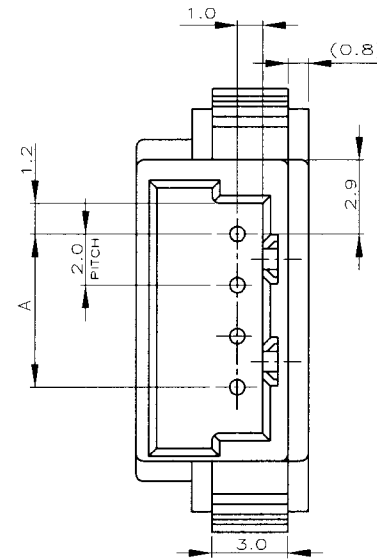

NOTES;

- MATERIAL: HOUSING - 66 NYLON (UL94V-0)  
POST - TIN BRASS
- THE PANEL SHOULD BE PUNCHED SO THAT THE HOUSING ENTERS THE PANEL IN THE SAME DIRECTION AS PUNCH.

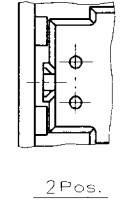
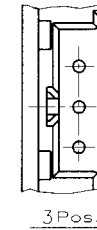

7-292254-5	5-292254-5	3-292254-5	1-292254-5	15	37.6	34.0	33.8	28.0
7- -4	5- -4	3- -4	1- -4	14	35.6	32.0	31.8	26.0
7- -3	5- -3	3- -3	1- -3	13	33.6	30.0	29.8	24.0
7- -2	5- -2	3- -2	1- -2	12	31.6	28.0	27.8	22.0
7- -1	5- -1	3- -1	1- -1	11	29.6	26.0	25.8	20.0
7- -0	5- -0	3- -0	1- -0	10	27.6	24.0	23.8	18.0
6- -9	4- -9	2- -9	-9	9	25.6	22.0	21.8	16.0
6- -8	4- -8	2- -8	-8	8	23.6	20.0	19.8	14.0
6- -7	4- -7	2- -7	-7	7	21.6	18.0	17.8	12.0
6- -6	4- -6	2- -6	-6	6	19.6	16.0	15.8	10.0
6- -5	4- -5	2- -5	-5	5	17.6	14.0	13.8	8.0
6- -4	4- -4	2- -4	-4	4	15.6	12.0	11.8	6.0
6- -3	4- -3	2- -3	-3	3	13.6	10.0	9.8	4.0
6-292254-2	4-292254-2	2-292254-2	292254-2	2	11.6	8.0	7.8	2.0
BLACK	YELLOW	BLUE	NATURAL	Pos.	D	C	B	A

THIS DRAWING IS A CONTROLLED DOCUMENT.

DIMENSIONS: MM

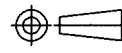

SEE NOTE

TOLERANCES UNLESS OTHERWISE SPECIFIED:

- 0 PLC ±
- 1 PLC ±
- 2 PLC ±
- 3 PLC ±
- 4 PLC ±
- ANGLES ±
- FINISH ±

SEE NOTE

DWN S.XU 31JAN03

CHK S.YAO 31JAN03

APVD T.SASAKI 31JAN03

PRODUCT SPEC

APPLICATION SPEC

WEIGHT

CUSTOMER DRAWING

tyco Tyco Electronics Corporation  
SHANGHAI, CHINA

PANEL MOUNT TYPE RELAY POST HEADER ASS'Y  
(AMP CT CONNECTOR 2mm PITCH)

SIZE A3 CAGE CODE 00779 DRAWING NO C-292254 RESTRICTED TO

SCALE 5:1 SHEET 1 OF 1 REV 0