

**Customer Part:**
**Description**

- Standard 5x3.2mm SMD crystal with four pads.  
Ceramic package with a seam sealed metal lid, hermetically sealed.
- Model CFPX-104
- Model Issue number 9

**Frequency Parameters**

- Frequency 24.5760MHz
- Frequency Tolerance  $\pm 20.00$ ppm
- Tolerance Condition @ 25°C
- Frequency Stability  $\pm 30.00$ ppm
- Operating Temperature Range -40.00 to 85.00°C
- Overtone Order Fundamental
- Ageing  $\pm 3$ ppm max per year @ 25°C

**Electrical Parameters**

- Load Capacitance (CL) 18.00pF
- Shunt Capacitance (C0) 7pF max
- Drive Level 100µW max
- ESR 40.00Ω max

**Environmental Parameters**

- Shock: 1500g, 0.5ms, 3 times in each of 3 mutually perpendicular planes
- Vibration: 20g (20Hz-2000Hz), 1.52mm amplitude, 20mins in 3 mutually perpendicular planes, 4 cycles
- Storage Temperature Range: -55 to 125°C

**Manufacturing Details**

- RoHS Terminations Au 0.3µm~1.0µm
- RoHS Reflow Temp 260degC max for 30s max

**Compliance**

- RoHS Status (2015/863/EU) Compliant
- REACH Status Compliant
- MSL Rating (JDEC-STD-033): Not Applicable

**Packaging Details**

- Tape & reel in accordance with EIA-481  
Quantities below the standard reel size to be supplied on cut tape.  
Standard Quantity: 1,000 Pieces

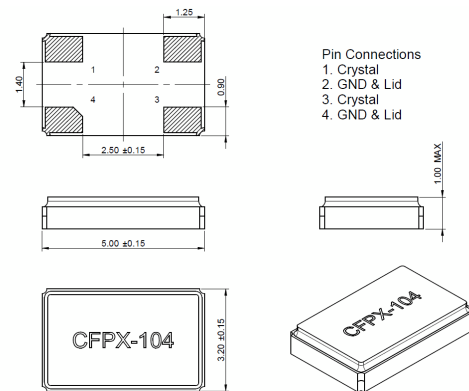
**Outline (mm)**

NOTE: The chamfer may appear on pad 1 or 4.  
This causes no change to the electrical performance of the device.

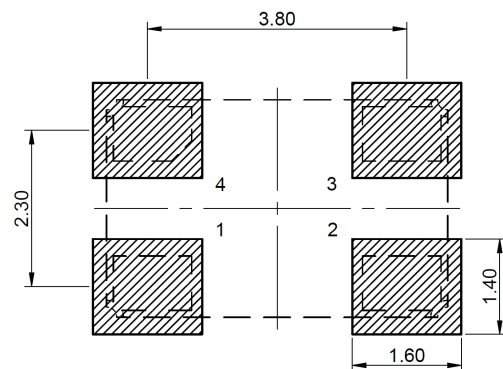
**Recommended Solder Pad Layout**

**Sales Office Contact Details:**

UK: +44 (0)1460 270200

USA: +1.760 668 8935

 Email: [info@iqdfrequencyproducts.com](mailto:info@iqdfrequencyproducts.com)

 Web: [www.iqdfrequencyproducts.com](http://www.iqdfrequencyproducts.com)