

PRODUCT NUMBER
10106814-0XX0X2LF

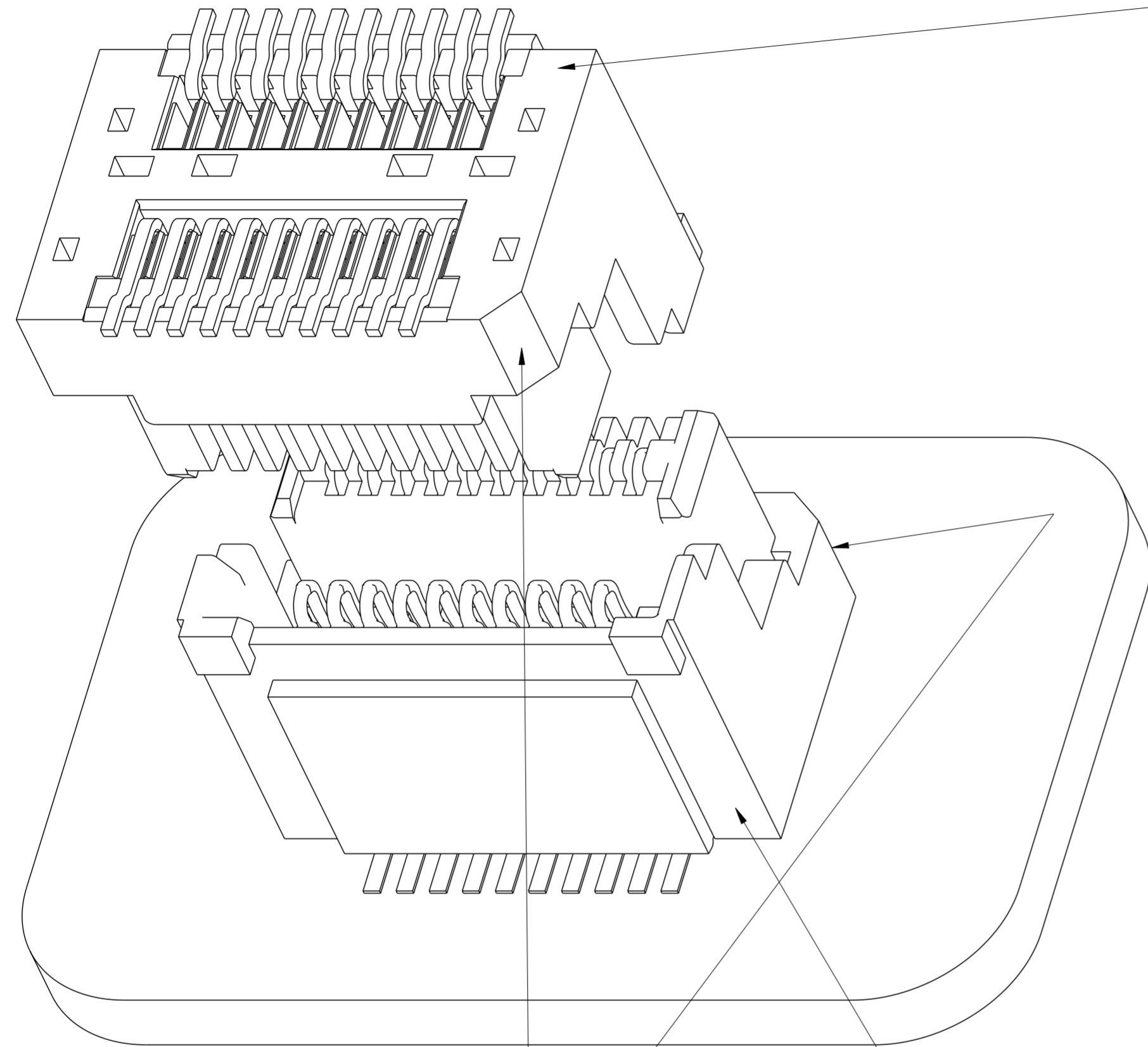

10106814-0XX0X2LF
HERMAPHRODITIC CONNECTOR
ASSEMBLY

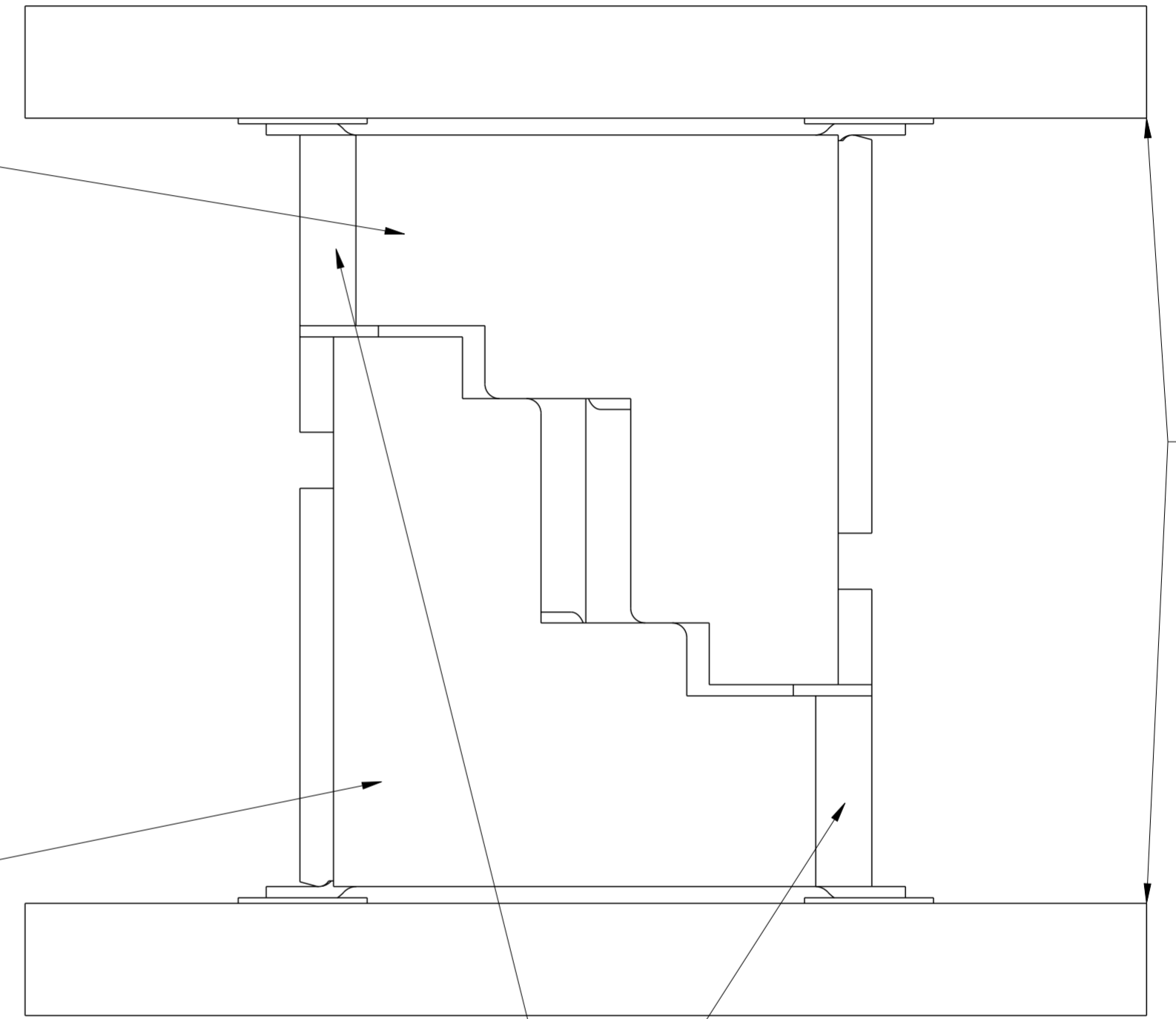

PRINTED
CIRCUIT
BOARD

CONNECTOR ORIENTATION
FEATURE
SEE PCB LAYOUT ON PAGE 5

10106814-0XX0X2LF
HERMAPHRODITIC CONNECTOR
ASSEMBLY

CONNECTOR ORIENTATION
FEATURE
SEE PCB LAYOUT ON PAGE 5

Amphenol
FCi

© 2020 Amphenol Corporation

spec ref	---	dr	Stu Stoner	2010/1/22	projection	mm	size	A2	scale	20:1											
tolerance std	ASME Y14.5	eng	Yuan-Yuan Bao	2022/04/06			ecn no	ELX-N-44329-1													
TOLERANCES UNLESS OTHERWISE SPECIFIED		chr	-	appr			Tim Yao	2022/04/08	product family	MezzoStack	rel level	Released									
surface	<table border="1"> <tr> <td>linear</td> <td>0.X</td> <td>±0.3</td> </tr> <tr> <td></td> <td>0.XX</td> <td>±0.15</td> </tr> <tr> <td></td> <td>0.XXX</td> <td>±0.05</td> </tr> <tr> <td>angular</td> <td>0°</td> <td>±3°</td> </tr> </table>	linear	0.X	±0.3				0.XX	±0.15		0.XXX	±0.05	angular	0°	±3°			Amphenol FCI TITLE HERMAPHRODITIC CONNECTOR, SHORT STYLE 20-90 POS, 0.5MM CTR, 4-7MM STACK HT www.fci.com		cat. no. -	Product - Customer Drw
linear	0.X	±0.3																			
	0.XX	±0.15																			
	0.XXX	±0.05																			
angular	0°	±3°																			

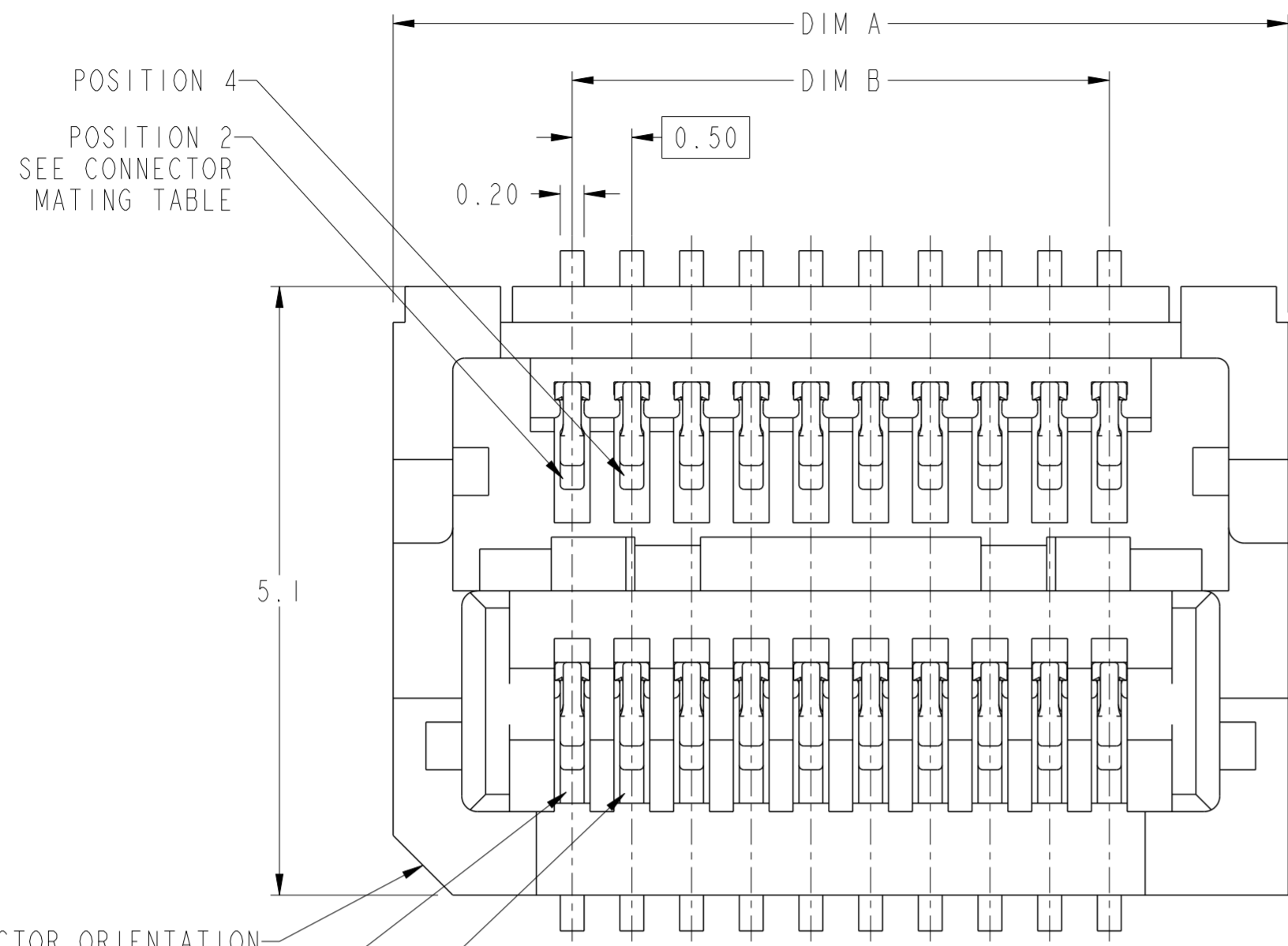

POSITION 4
 POSITION 2
 SEE CONNECTOR
 MATING TABLE

CONNECTOR ORIENTATION
 FEATURE

POSITION 1
 SEE CONNECTOR
 MATING TABLE

POSITION 3

5.1

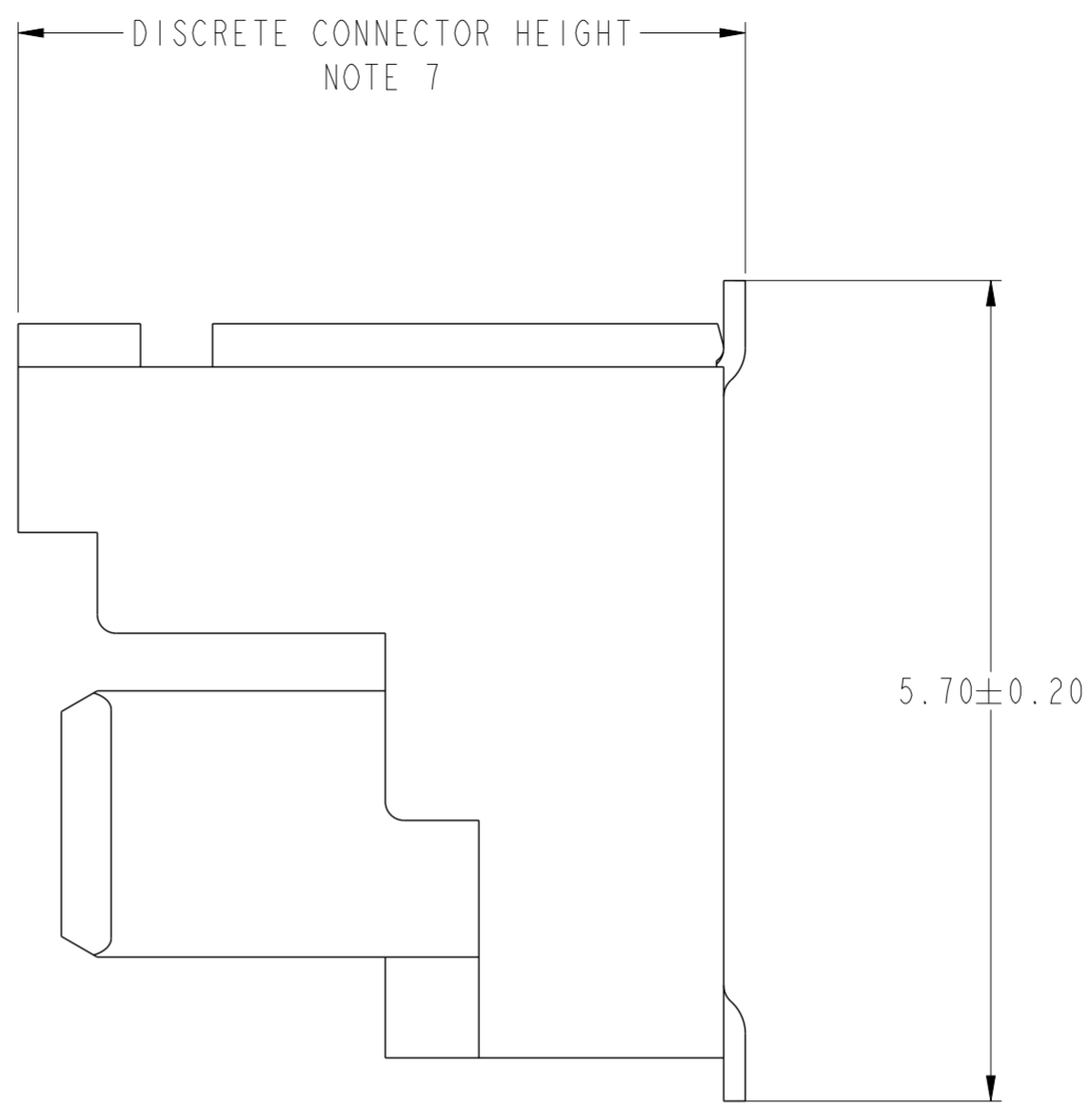

HERMAPHRODITIC CONNECTOR MATING	
CONNECTOR POSITION	MATES WITH CONNECTOR POSITION
1	2
3	4
5	6
7	8
9	10
ETC.	

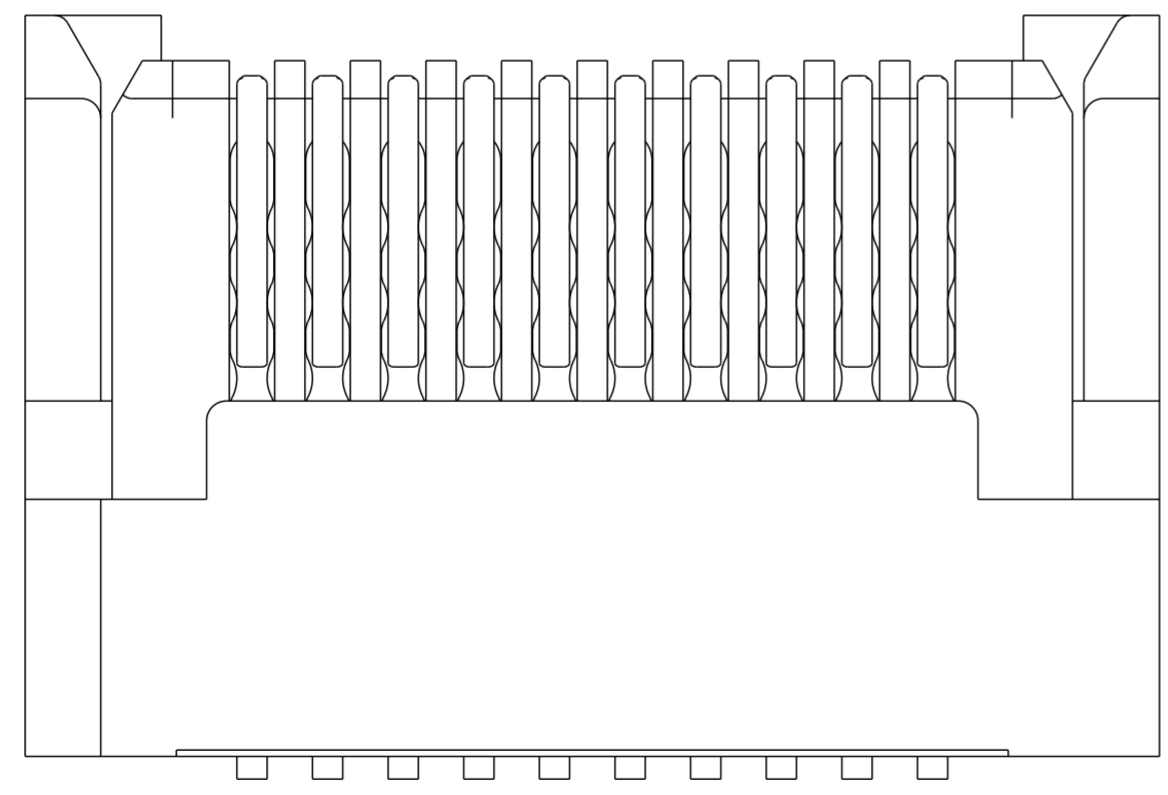

10106814-024002LF SHOWN
 WITHOUT STANDARD PICK-UP CAP

Amphenol
 FCI

© 2020 Amphenol Corporation

spec ref	---	dr	Stu Stoner	2010/1/22	projection	mm	size	A2	scale	20:1
tolerance std	ASME Y14.5	eng	Yuan-Yuan Bao	2022/04/06	chr	-	ecn no	ELX-N-44329-1		
TOLERANCES UNLESS OTHERWISE SPECIFIED		appr	Tim Yao	2022/04/08	product family	MezzoStak	rel level	Released		
surface	linear	0.X	±0.3		title		10106814	rev E		
		0.XX	±0.15		HERMAPHRODITIC CONNECTOR, SHORT STYLE					
		0.XXX	±0.05		20-90 POS, 0.5MM CTR, 4-7MM STACK HT					
ASME Y14.5	angular	0°	±3°	www.fci.com	cat. no.	-	Product - Customer Drw	sheet 2 of 8		

PDS: Rev :E

STATUS:Released

Printed: May 24, 2022

	1	2	3	4	5	6	7	8
	PRODUCT NUMBER	NUMBER OF POSITIONS	DIM A	DIM B	DISCRETE CONNECTOR HEIGHT NOTE 9	PRACTICAL CONNECTOR HEIGHT NOTE 8	DIM.E OVER ALL HEIGHT (CAP IS INCLUDED)	STATUS
A	10106814-021002LF	20	7.5	4.5	3.55	2.00	4.05	RELEASED
	10106814-031002LF	30	10.0	7.0				
	10106814-041002LF	40	12.5	9.5				
	10106814-051002LF	50	15.0	12.0				
	10106814-061002LF	60	17.5	14.5				
	10106814-071002LF	70	20.0	17.0	4.05	2.50	4.55	UN-RELEASED
	10106814-081002LF	80	22.5	19.5				
	10106814-022002LF	20	7.5	4.5				
	10106814-032002LF	30	10.0	7.0				
	10106814-042002LF	40	12.5	9.5				
B	10106814-052002LF	50	15.0	12.0	4.55	3.00	5.05	RELEASED
	10106814-062002LF	60	17.5	14.5				
	10106814-072002LF	70	20.0	17.0				
	10106814-023002LF	20	7.5	4.5				
	10106814-033002LF	30	10.0	7.0				
	10106814-043002LF	40	12.5	9.5				UN-RELEASED
	10106814-053002LF	50	15.0	12.0				
	10106814-063002LF	60	17.5	14.5				
	10106814-073002LF	70	20.0	17.0				
	10106814-083002LF	80	22.5	19.5				
C	10106814-083202LF	80	22.5	19.5	5.05	3.50	5.55	UN-RELEASED
	10106814-093002LF	90	25.0	22.0				UN-RELEASED
	10106814-093012LF	90	25.0	22.0				RELEASED
	10106814-093202LF	90	25.0	22.0				RELEASED
	10106814-024002LF	20	7.5	4.5				RELEASED
	10106814-034002LF	30	10.0	7.0				
	10106814-044002LF	40	12.5	9.5				
	10106814-054002LF	50	15.0	12.0				
	10106814-064002LF	60	17.5	14.5				
	10106814-074002LF	70	20.0	17.0				

0.5 BTB HERMAPHRODITIC CONNECTOR ASSEMBLY PART NUMBER SCHEME

EXAMPLE: 10106814-XX X X X 2 LF

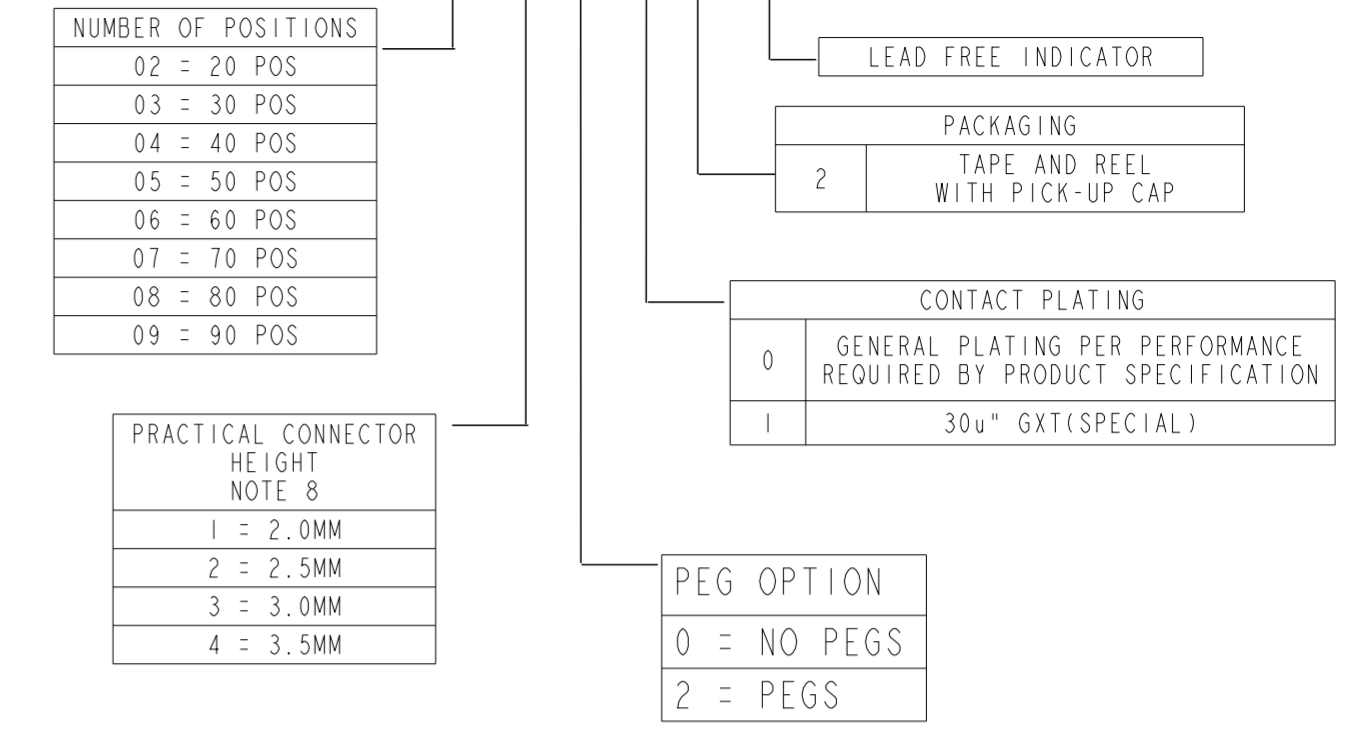

Amphenol FCI
© 2020 Amphenol Corporation

spec ref	---	dr	Stu Stoner	2010/1/22	projection	mm	size	A2	scale	10:1	
tolerance std	ASME Y14.5	eng	Yuan-Yuan Bao	2022/04/06	chr	-	ecn no	ELX-N-44329-1	rel level	Released	
TOLERANCES UNLESS OTHERWISE SPECIFIED		appr	Tim Yao	2022/04/08	product family	MezzoStak	rel level	Released			
surface	ASME Y14.5	linear	0.X ±0.3 0.XX ±0.15 0.XXX ±0.05	angular	0° ±3°	Amphenol FCI	HERMAPHRODITIC CONNECTOR, SHORT STYLE	cat. no.	10106814	rev	E
		www.fci.com			Product - Customer Drw		sheet 3 of 8				

PDS: Rev :E

STATUS:Released

Printed: May 24, 2022

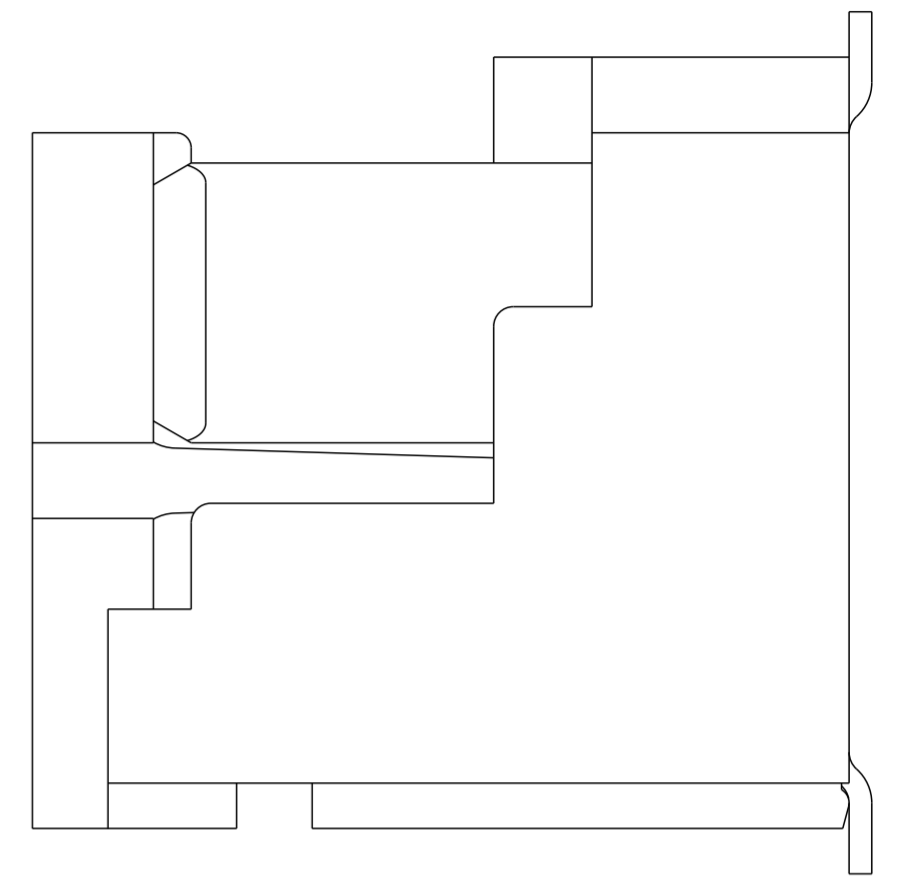
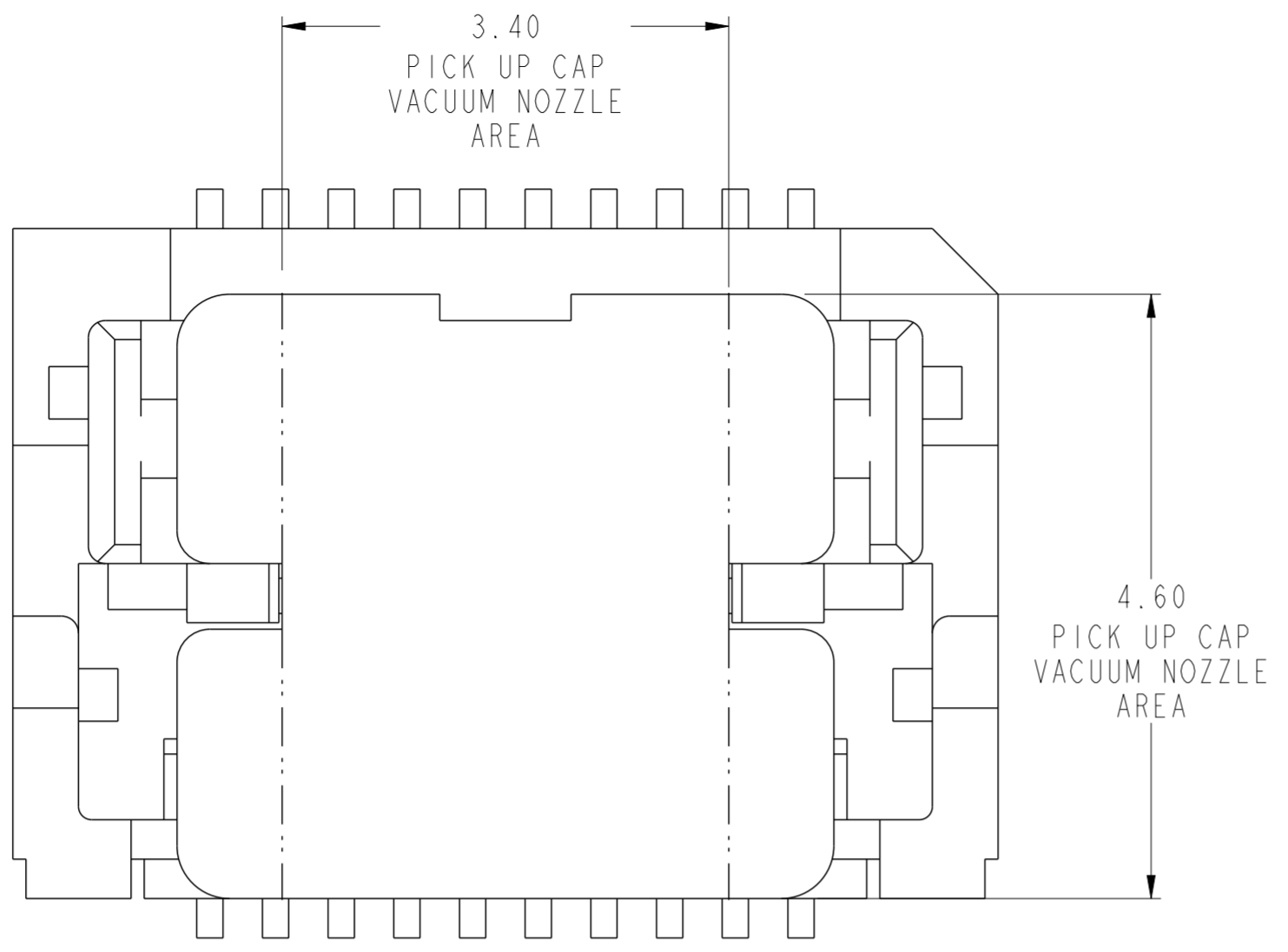

10106814-024002LF SHOWN
WITH STANDARD PICK-UP CAP

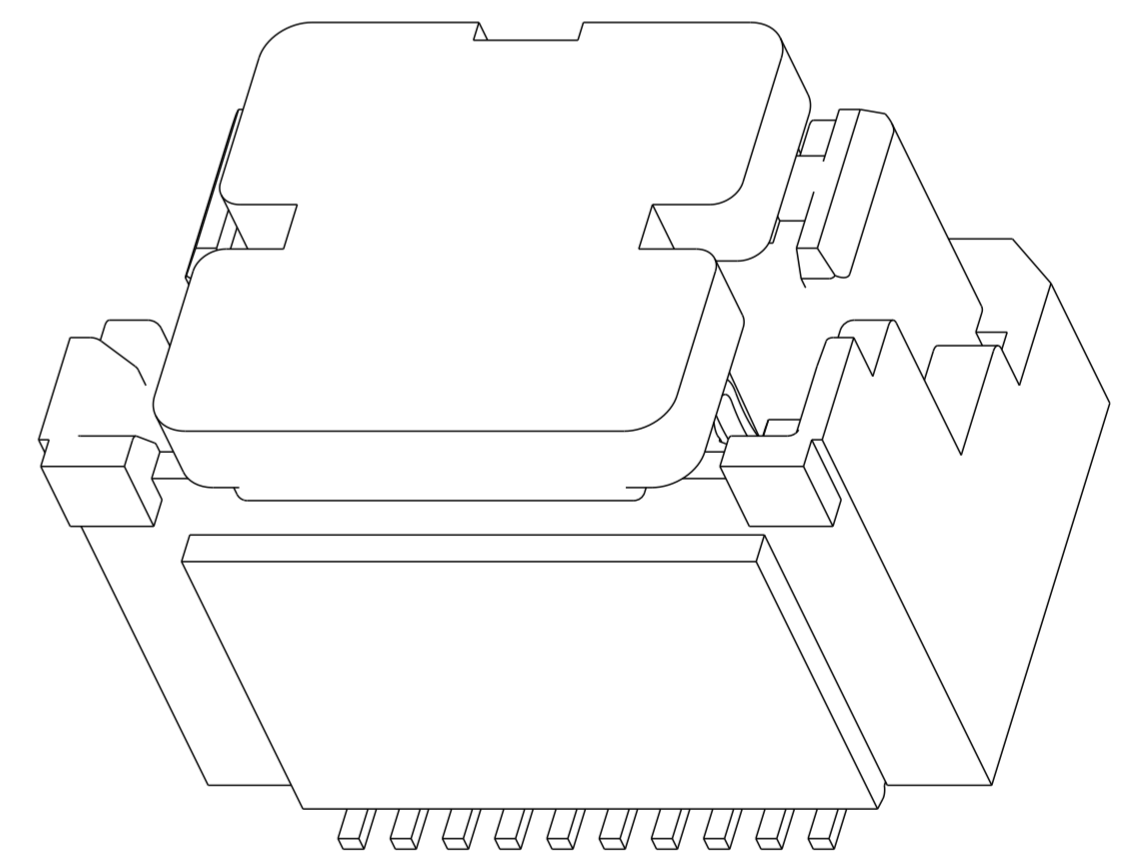
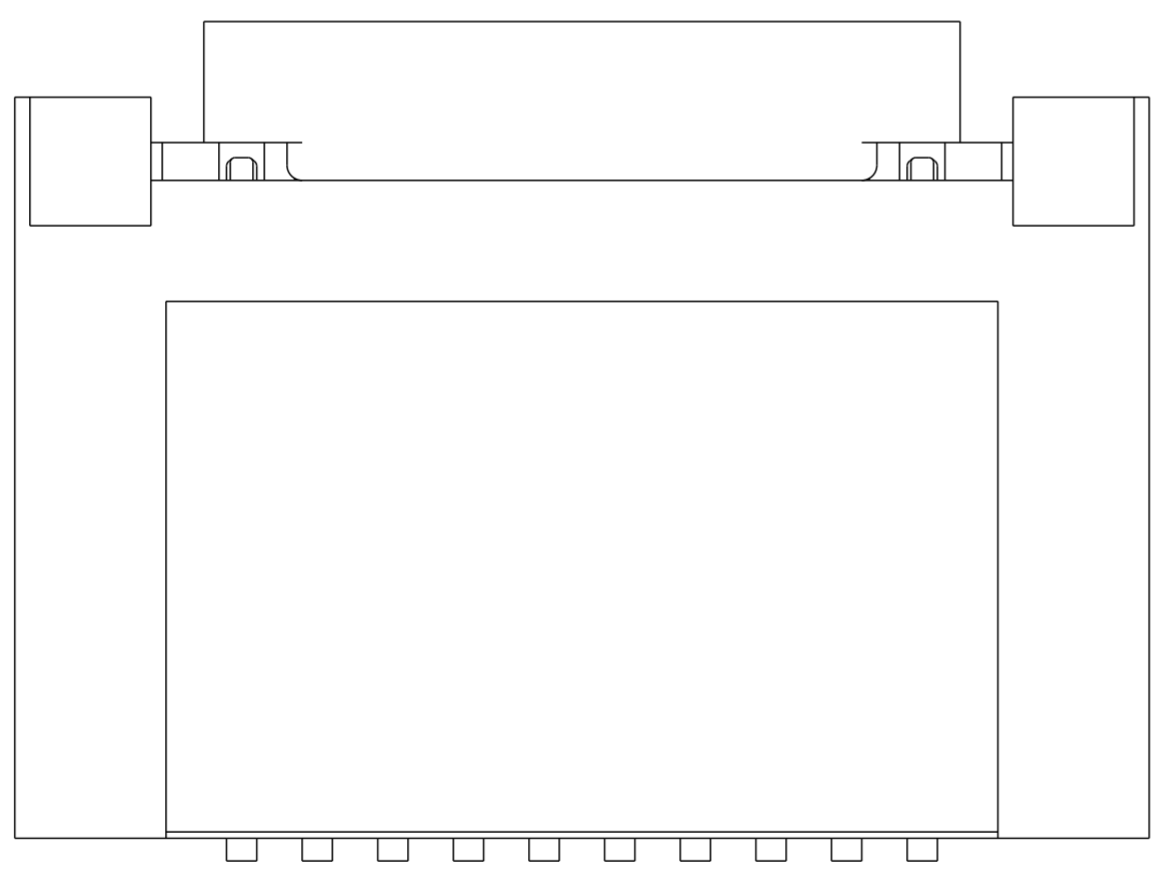

PLEASE REFER PAGE 3 TO GET THE DETAILED DIMENSION VALUE OF DIM.E

Amphenol FCI
© 2020 Amphenol Corporation

spec ref	---	dr	Stu Stoner	2010/1/22	projection	mm	size	A2	scale	20:1
tolerance std	ASME Y14.5	eng	Yuan-Yuan Bao	2022/04/06	chr	-	ecn no	ELX-N-44329-1	rel level	Released
TOLERANCES UNLESS OTHERWISE SPECIFIED		appr	Tim Yao	2022/04/08	product family	MezzoStak	rel level	Released		
surface	✓	linear	0.X	±0.3	Amphenol FCI	HERMAPHRODITIC CONNECTOR, SHORT STYLE	div no	10106814	rev	E
			0.XX	±0.15						
			0.XXX	±0.05						
ASME Y14.5	angular		0°	±3°	www.fci.com	cat. no.	-	Product - Customer Drw	sheet 4 of 8	

PDS: Rev :E

STATUS:Released

Printed: May 24, 2022

PRODUCT NUMBER	NUMBER OF POSITIONS	DIM A	DIM B	DIM C	PEGS STATUS	DIM_D
10106814-02X002LF	20	2.25	4.50	7.50	NO	N/A
10106814-03X002LF	30	3.50	7.00	10.00	NO	N/A
10106814-04X002LF	40	4.75	9.50	12.50	NO	N/A
10106814-05X002LF	50	6.00	12.00	15.00	NO	N/A
10106814-06X002LF	60	7.25	14.50	17.50	NO	N/A
10106814-07X002LF	70	8.50	17.00	20.00	NO	N/A
10106814-08X002LF	80	9.75	19.50	22.50	NO	N/A
10106814-09X0X2LF	90	11.00	22.00	25.00	NO	N/A
10106814-08X202LF	80	9.75	19.50	22.50	YES	22.00
10106814-09X202LF	90	11.00	22.00	25.00	YES	24.50

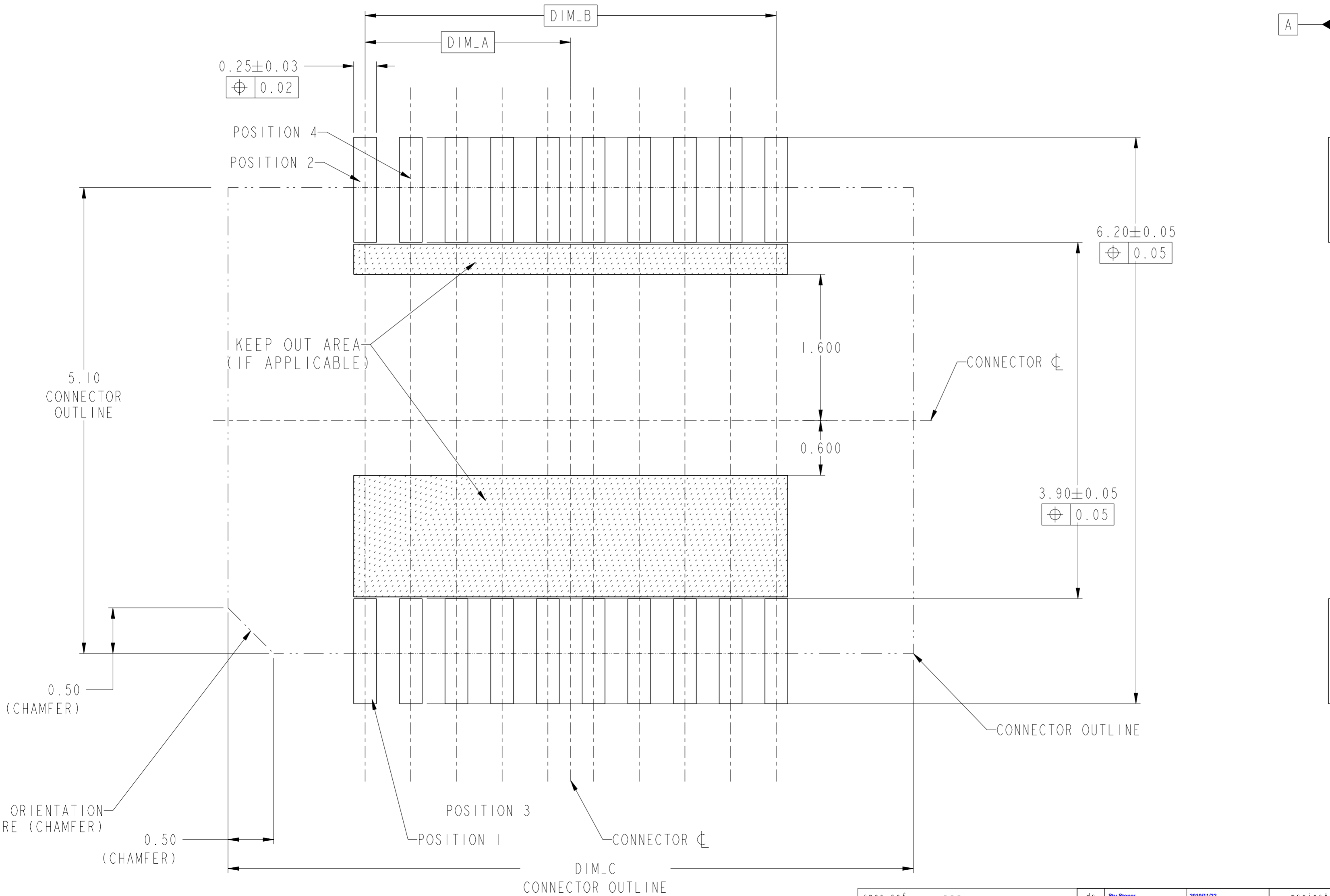

OPTION 1 - SPACE OPTIMIZED FOOTPRINT
SEE TABLE FOR CONNECTOR LAYOUT DIMENSIONS
SEE NOTE 8 FOR STENCIL CREATION GUIDELINES

spec ref	---	dr	Stu Stoner	2010/1/22	projection	mm	size	A2	scale	30:1
tolerance std	ASME Y14.5	eng	Yuan-Yuan Bao	2022/04/06	chr	-	ecn no	ELX-N-44329-1	rel level	Released
surface	linear	app	Tim Yao	2022/04/08	product family	MezzoStack	cat. no.	10106814	rev	E
	angular									

PRODUCT NUMBER	NUMBER OF POSITIONS	DIM A	DIM B	DIM C	PEGS STATUS	DIM_D
10106814-02X002LF	20	2.25	4.50	7.50	NO	N/A
10106814-03X002LF	30	3.50	7.00	10.00	NO	N/A
10106814-04X002LF	40	4.75	9.50	12.50	NO	N/A
10106814-05X002LF	50	6.00	12.00	15.00	NO	N/A
10106814-06X002LF	60	7.25	14.50	17.50	NO	N/A
10106814-07X002LF	70	8.50	17.00	20.00	NO	N/A
10106814-08X002LF	80	9.75	19.50	22.50	NO	N/A
10106814-09X0X2LF	90	11.00	22.00	25.00	NO	N/A
10106814-08X202LF	80	9.75	19.50	22.50	YES	22.00
10106814-09X202LF	90	11.00	22.00	25.00	YES	24.50

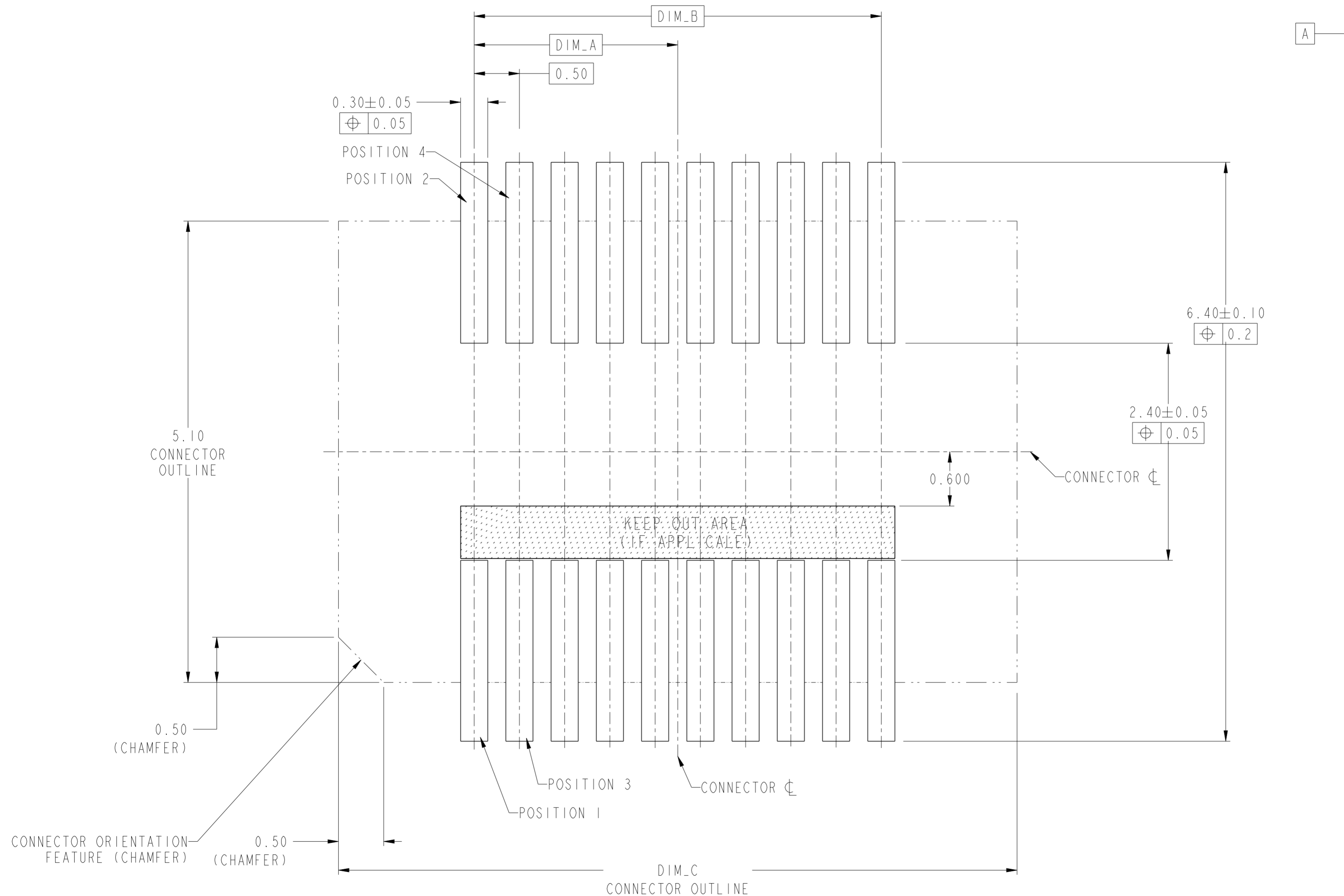

OPTION 2 - FOOTPRINT
SEE TABLE FOR CONNECTOR LAYOUT DIMENSIONS
SEE NOTE 8 FOR STENCIL CREATION GUIDELINES

spec ref	---	dr	Stu Stoner	2010/11/22	projection	mm	size	A2	scale	10:1
tolerance std	ASME Y14.5	eng	Yuan-Yuan Bao	2022/04/06	chr	-	ecn no	ELX-N-44329-1	rel level	Released
surface	linear	app	Tim Yao	2022/04/08	product family	MezzoStak	title	HERMAPHRODITIC CONNECTOR, SHORT STYLE	div no	10106814
ASME Y14.5	angular	0°	±3°	www.fci.com	cat. no.	-	Product - Customer Drw	sheet 6 of 8	rev	E

10106814-0932X2LF SHOWN

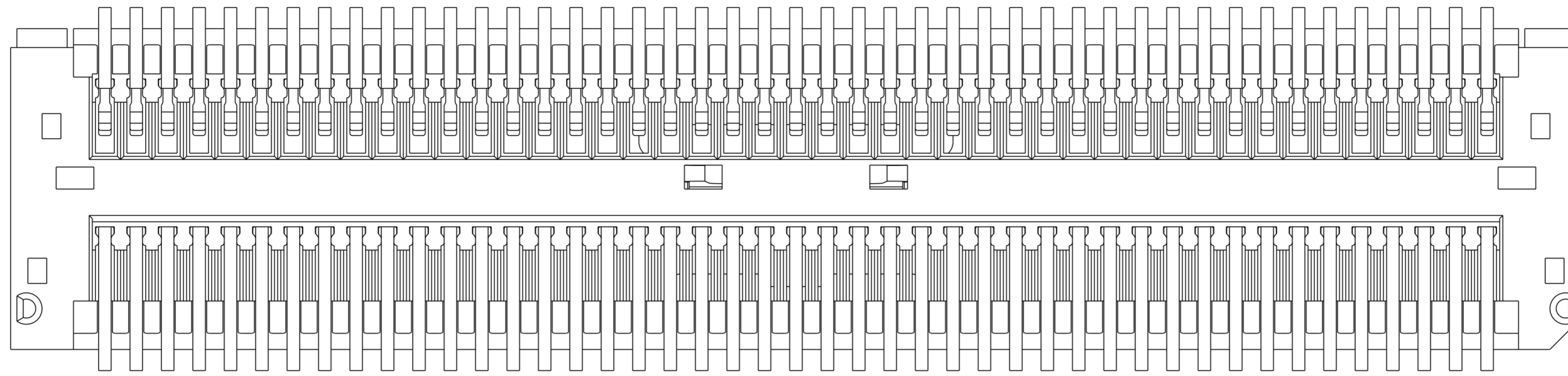

SCALE 15:1

2X (Ø0.50) PEGS FEATURE
ONLY FOR 10106814-083202LF
AND 10106814-093202LF

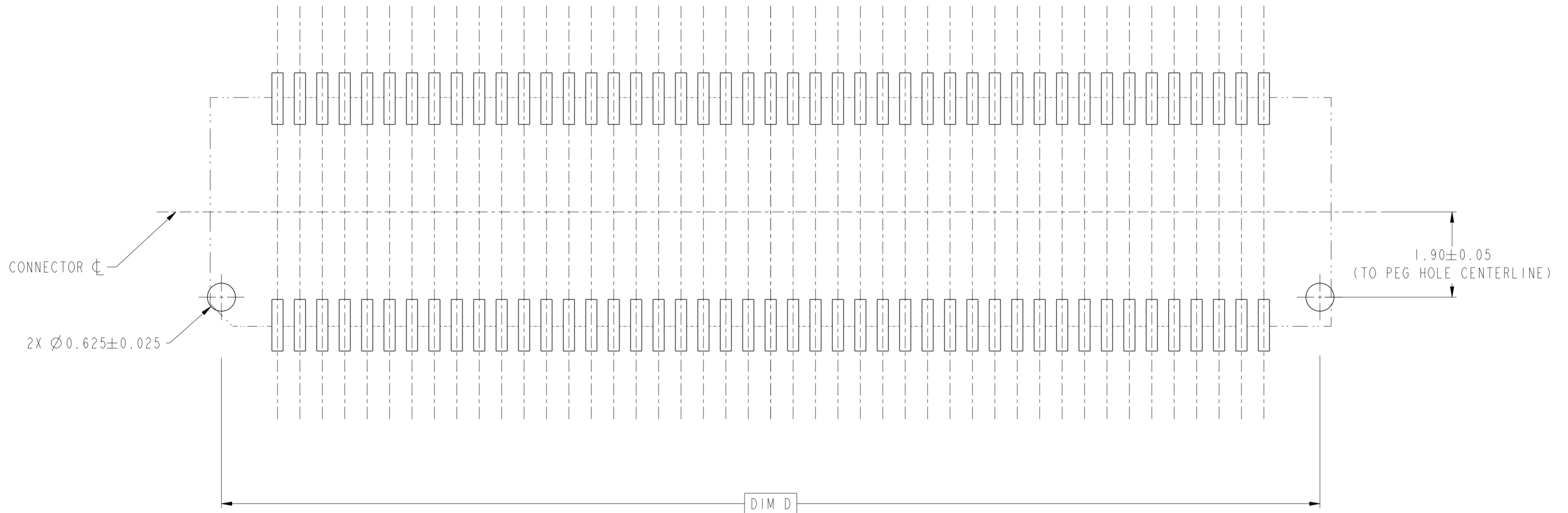

PCB LAYOUT FOR 10106814-083202LF AND 10106814-093202LF
OTHER DIMENSIONS, SEE SHEET 5 AND 6

SCALE 15:1

spec ref	---	dr	Stu Stoner	2010/11/22	projection	mm	size	A2	scale	10:1	
tolerance std	ASME Y14.5	eng	Yuan-Yuan Bao	2022/04/06			ecn no	ELX-N-44329-1	rel level Released		
TOLERANCES UNLESS OTHERWISE SPECIFIED		chr	-	app			Tim Yao	2022/04/08		product family	MezzoStack
surface	linear 0.X ±0.3 0.XX ±0.15 0.XXX ±0.05 angular 0° ±3°	Amphenol FCI www.fci.com		title HERMAPHRODITIC CONNECTOR, SHORT STYLE 20-90 POS, 0.5MM CTR, 4-7MM STACK HT			dwg no 10106814	rev E			
		cat. no.			Product - Customer Drw		sheet 7 of 8				

NOTES

- 1 - MATERIAL:
HOUSING - HIGH-TEMPERATURE THERMOPLASTIC, UL94-V0, COLOR: BLACK
CONTACTS: COPPER ALLOY
CONTACT PLATING:
SEPARABLE INTERFACE: PERFORMANCE-BASED PLATING, QUALIFIED TO MEET THE REQUIREMENTS OF FCI PRODUCT SPECIFICATION.
SOLDER TAILS: GOLD FLASH.
- 2 - RECOMMENDED LEAD FREE SOLDER PASTE THICKNESS 150µm.
- 3 - THE HOUSING WILL WITHSTAND EXPOSURE TO 260°C PEAK TEMPERATURE FOR 30 SECONDS IN A CONVECTION INFRA RED OR VAPOR PHASE REFLOW OVEN.
- 4 - THIS PRODUCT MEETS EUROPEAN UNION DIRECTIVES AND OTHER COUNTRY REGULATION AS DESCRIBED IN GS-22-008
- 5 - PACKAGING TAPE AND REEL. PACKAGING SPECIFICATION GS-14-1320, PRODUCT SPECIFICATION GS-12-1322.
- 6 - PRACTICAL CONNECTOR HEIGHT AS SPECIFIED IN THE TABLE IS NOT THE DIMENSIONAL HEIGHT OF THE CONNECTOR BUT THE HEIGHT AS IT PERTAINS TO TOTAL STACK HEIGHT. AN EXAMPLE IS A CONNECTOR WITH A 2.5MM PRACTICAL CONNECTOR HEIGHT, WHEN MATED TO ITSELF WILL RESULTING IN A BOARD TO BOARD STACK HEIGHT OF 5MM.
- 7 - DISCRETE CONNECTOR HEIGHT AS SHOWN IN THE TABLE IS THE ACTUAL DIMENSIONAL CONNECTOR HEIGHT. ALSO SEE INFORMATION ON PRACTICAL HEIGHT IN NOTE 6.
- 8 - REFER TO IPC 7525-A FOR STENCIL CREATION.

Amphenol FCI

© 2020 Amphenol Corporation

spec ref	---	dr	Stu Stoner	2010/1/22	projection		mm	size	A2	scale	20:1												
tolerance std	ASME Y14.5	eng	Yuan-Yuan Bao	2022/04/06	chr	-	ecn no	ELX-N-44329-1	rel level	Released													
ASME Y14.5	TOLERANCES UNLESS OTHERWISE SPECIFIED	appr	Tim Yao	2022/04/08	product family	MezzoStak	div no	10106814	rev	E													
surface	<table border="1"> <tr> <td>linear</td> <td>0.X</td> <td>±0.3</td> </tr> <tr> <td></td> <td>0.XX</td> <td>±0.15</td> </tr> <tr> <td></td> <td>0.XXX</td> <td>±0.05</td> </tr> <tr> <td>angular</td> <td>0°</td> <td>±3°</td> </tr> </table>	linear	0.X	±0.3		0.XX	±0.15		0.XXX	±0.05	angular	0°	±3°	Amphenol FCI	title	HERMAPHRODITIC CONNECTOR, SHORT STYLE		cat. no.	-	Product - Customer Drw	sheet 8 of 8		
linear	0.X	±0.3																					
	0.XX	±0.15																					
	0.XXX	±0.05																					
angular	0°	±3°																					