

## Transient Voltage Suppressor

### FEATURES

- Excellent clamping capability
- Low dynamic impedance
- 500W surge capability at 10 / 1000  $\mu$ s waveform
- Fast response time: Typically less than 1.0ps from 0 volt to  $V_{BR}$  for unidirectional and 5.0ns for bidirectional
- Typical  $I_R$  less than 1 $\mu$ A above 10V
- Compliant to RoHS Directive 2011/65/EU and in accordance to WEEE 2002/96/EC
- Halogen-free according to IEC 61249-2-21 definition

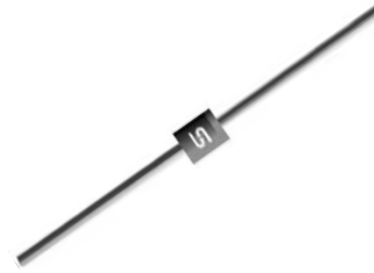

**DO-204AC (DO-15)**

### MECHANICAL DATA

**Case:** DO-204AC (DO-15)

Molding compound, UL flammability classification rating 94V-0

Base P/N with suffix "G" on packing code - green compound (halogen-free)

**Terminal:** Matte tin plated leads, solderable per JESD22-B102

Meet JESD 201 class 1A whisker test,

**Weight:** 0.4g (approximately)

MAXIMUM RATINGS AND ELECTRICAL CHARACTERISTICS ( $T_A=25^\circ\text{C}$ unless otherwise noted)			
PARAMETER	SYMBOL	VALUE	UNIT
Peak power dissipation at $T_A=25^\circ\text{C}$ , $T_p=1\text{ms}$ (Note 1)	$P_{PK}$	500	Watts
Steady state power dissipation at $T_L=75^\circ\text{C}$ lead lengths .375", 9.5mm (Note 2)	$P_D$	3	Watts
Peak forward surge current, 8.3 ms single half sine-wave superimposed on rated load (Note 3)	$I_{FSM}$	70	A
Maximum instantaneous forward voltage at 35 A for Unidirectional only	$V_F$	3.5	Volts
Operating junction temperature range	$T_J$	- 55 to +175	$^\circ\text{C}$
Storage temperature range	$T_{STG}$	- 55 to +175	$^\circ\text{C}$

Note 1: Non-repetitive Current Pulse Per Fig. 3 and Derated above  $T_A=25^\circ\text{C}$  Per Fig. 2

Note 2: Mounted on 10 x 10 mm Copper Pads to Each Terminal

Note 3: 8.3ms Single Half Sine-wave or Equivalent Square Wave, Duty Cycle=4 Pulses Per Minute Maximum

### Devices for Bipolar Applications

1. For Bidirectional Use C or CA Suffix for Types SA5.0 through Types SA170.
2. Electrical Characteristics Apply in Both Directions

ORDERING INFORMATION				
PART NO.	PACKING CODE	GREEN COMPOUND CODE	PACKAGE	PACKING
SAxxx (Note 1)	A0	Suffix "G"	DO-15	1,500 / Ammo box
	R0		DO-15	3,500 / 13" Paper reel
	B0		DO-15	1,000 / Bulk packing

Note 1: "xxx" defines voltage from 5.0V (SA5.0) to 170V (SA170)

EXAMPLE				
PREFERRED P/N	PART NO.	PACKING CODE	GREEN COMPOUND CODE	DESCRIPTION
SA10 A0	SA10	A0		
SA10 A0G	SA10	A0	G	Green compound

RATINGS AND CHARACTERISTICS CURVES

(TA=25°C unless otherwise noted)

FIG. 1- PEAK PULSE POWER RATING CURVE

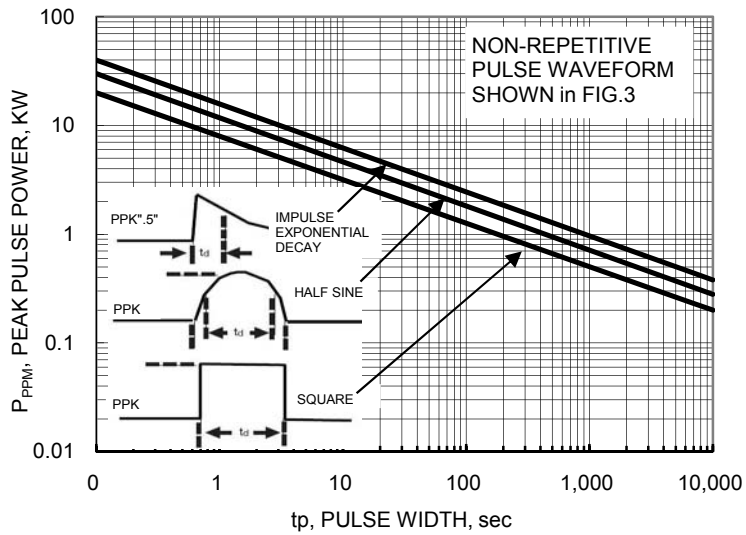

FIG.2- POWER DERATING CURVE

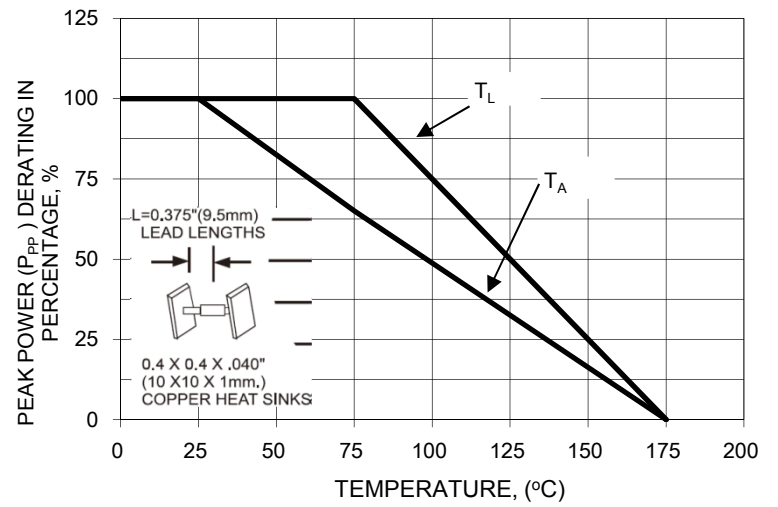

FIG. 3- CLAMPING POWER PULSE WAVEFORM

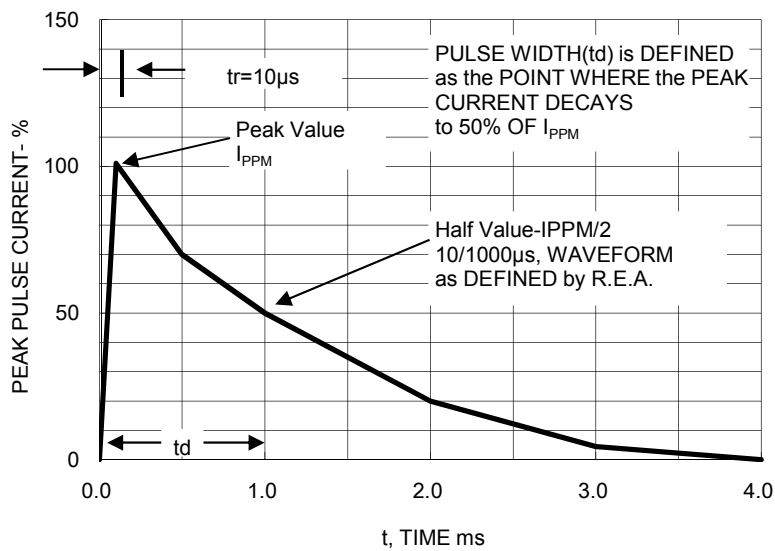

FIG. 4- MAXIMUM NON-REPETITIVE FORWARD SURGE CURRENT UNIDIRECTIONAL ONLY

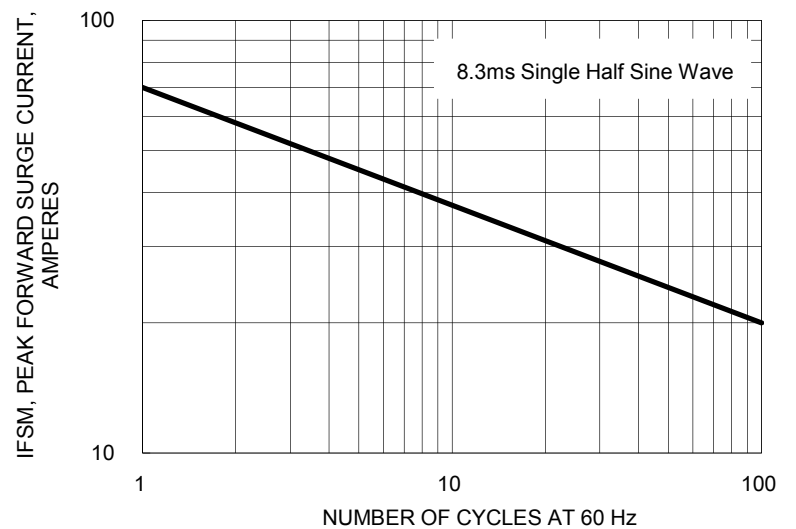
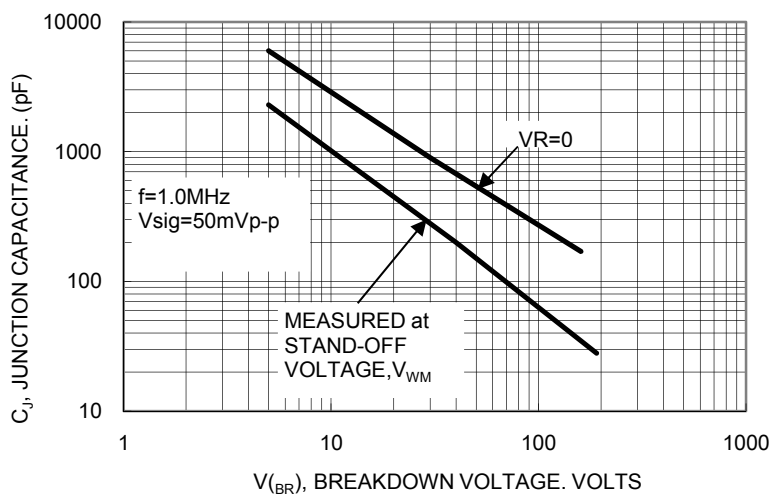

FIG. 5- TYPICAL JUNCTION CAPACITANCE (UNIDIRECTIONAL)



General Part Number	Breakdown Voltage (Note 1)		Test Current	Stand-Off Voltage	Maximum Reverse Leakage @ $V_{WM}$	Maximum Peak Surge Current	Maximum Clamping Voltage @ $I_{PPM}$	Maximum Temperature Coefficient
	$V_{BR}$							
	V		mA	V	$\mu A$	A	V	mV / °C
	Min.	Max.				(Note 2)		
SA5.0	6.40	7.30	10	5.0	600	54.0	9.6	5
SA5.0A	6.40	7.00	10	5.0	600	57.0	9.2	5
SA6.0	6.67	8.15	10	6.0	600	46.0	11.4	5
SA6.0A	6.67	7.37	10	6.0	600	50.0	10.3	5
SA6.5	7.22	8.82	10	6.5	400	42.0	12.3	5
SA6.5A	7.22	7.98	10	6.5	400	46.0	11.2	5
SA7.0	7.78	9.51	10	7.0	150	39.0	13.3	6
SA7.0A	7.78	8.60	10	7.0	150	43.0	12.0	6
SA7.5	8.33	10.20	1	7.5	50	36.0	14.3	7
SA7.5A	8.33	9.21	1	7.5	50	40.0	12.9	7
SA8.0	8.89	10.9	1	8.0	25	35.0	15.0	7
SA8.0A	8.89	9.83	1	8.0	25	38.0	13.6	7
SA8.5	9.44	11.5	1	8.5	10	33.0	15.9	8
SA8.5A	9.44	10.4	1	8.5	10	36.0	14.4	8
SA9.0	10.0	12.2	1	9.0	5	31.0	16.9	9
SA9.0A	10.0	11.1	1	9.0	5	34.0	15.4	9
SA10	11.1	13.6	1	10	1	27.0	18.8	10
SA10A	11.1	12.3	1	10	1	30.0	17.0	10
SA11	12.2	14.9	1	11	1	26.0	20.1	11
SA11A	12.2	13.5	1	11	1	28.0	18.2	11
SA12	13.3	16.3	1	12	1	23.0	22.0	12
SA12A	13.3	14.7	1	12	1	26.3	19.9	12
SA13	14.4	17.6	1	13	1	22.0	23.8	13
SA13A	14.4	15.9	1	13	1	24.0	21.5	13
SA14	15.6	19.1	1	14	1	20.3	25.8	14
SA14A	15.6	17.2	1	14	1	22.6	23.2	14
SA15	16.7	20.4	1	15	1	19.5	26.9	16
SA15A	16.7	18.5	1	15	1	21.0	24.4	16
SA16	17.8	21.8	1	16	1	18.0	28.8	19
SA16A	17.8	19.7	1	16	1	20.0	26.0	17
SA17	18.9	23.1	1	17	1	17.0	30.5	20
SA17A	18.9	20.9	1	17	1	19.0	27.7	19
SA18	20.0	24.4	1	18	1	16.3	32.2	21
SA18A	20.0	22.1	1	18	1	17.9	39.4	20
SA20	22.2	27.1	1	20	1	14.0	35.5	25
SA20A	22.2	24.5	1	20	1	16.0	43.0	23
SA22	24.4	29.8	1	22	1	13.0	38.9	28
SA22A	24.4	26.9	1	22	1	14.7	46.6	25
SA24	26.7	32.6	1	24	1	12.0	42.1	31
SA24A	26.7	29.5	1	24	1	13.4	50.1	28
SA26	28.9	35.3	1	26	1	11.0	45.4	31
SA26A	28.9	31.9	1	26	1	12.4	53.5	30
SA28	31.1	38.0	1	28	1	10.0	48.4	35
SA28A	31.1	34.4	1	28	1	11.5	59.0	31
SA30	33.3	40.7	1	30	1	9.8	53.3	39
SA30A	33.3	36.8	1	30	1	10.8	64.3	36
SA33	36.7	44.9	1	33	1	8.8	58.1	42
SA33A	36.7	40.6	1	33	1	9.8	71.4	39

General Part Number	Breakdown Voltage (Note 1)		Test Current	Stand-Off Voltage	Maximum Reverse Leakage @ $V_{WM}$	Maximum Peak Surge Current	Maximum Clamping Voltage @ $I_{PPM}$	Maximum Temperature Coefficient
	$V_{BR}$							
	V		mA	V	$\mu A$	A	V	mV / °C
	Min.	Max.				(Note 2)		
SA36	40.0	48.9	1	36	1	8.1	64.5	46
SA36A	40.0	44.2	1	36.0	1	9.0	58.1	41
SA40	44.4	54.3	1	40	1	7.3	71.4	51
SA40A	44.4	49.1	1	40	1	8.1	64.5	46
SA43	47.8	58.4	1	43	1	6.8	76.7	55
SA43A	47.8	52.8	1	43	1	7.5	69.4	50
SA45	50.0	61.1	1	45	1	6.5	80.3	58
SA45A	50.0	55.3	1	45	1	7.2	72.7	52
SA48	53.3	65.2	1	48	1	6.1	85.5	63
SA48A	53.3	58.9	1	48	1	6.7	77.4	56
SA51	56.7	69.3	1	51	1	5.7	91.1	66
SA51A	56.7	62.7	1	51	1	6.3	82.4	61
SA54	60.0	73.3	1	54	1	5.4	86.3	71
SA54A	60.0	66.3	1	54	1	6.0	87.1	65
SA58	64.4	78.7	1	58	1	5.0	103	78
SA58A	64.4	71.2	1	58	1	5.6	93.6	70
SA60	66.7	81.5	1	60	1	4.9	107	80
SA60A	66.7	73.7	1	60	1	5.4	96.8	71
SA64	71.1	86.9	1	64	1	4.6	114	86
SA64A	71.1	78.6	1	64	1	5.0	103	76
SA70	77.8	95.1	1	70	1	4.2	125	94
SA70A	77.8	86.0	1	70	1	4.6	113	85
SA75	83.3	102	1	75	1	3.9	134	101
SA75A	83.3	92.1	1	75	1	4.3	121	91
SA78	86.7	103	1	78	1	3.7	139	105
SA78A	86.7	95.8	1	78	1	4.1	126	95
SA85	94.4	115	1	85	1	3.4	151	114
SA85A	94.4	104	1	85	1	3.8	137	103
SA90	100	122	1	90	1	3.2	160	121
SA90A	100	111	1	90	1	3.5	146	110
SA100	111	136	1	100	1	2.9	179	135
SA100A	111	123	1	100	1	3.2	162	123
SA110	122	149	1	110	1	2.6	196	148
SA110A	122	135	1	110	1	2.9	177	133
SA120	133	163	1	120	1	2.4	214	162
SA120A	133	147	1	120	1	2.7	193	146
SA130	144	176	1	130	1	2.2	230	175
SA130A	144	159	1	130	1	2.5	209	158
SA150	167	204	1	150	1	1.9	268	203
SA150A	167	185	1	150	1	2.1	243	184
SA160	178	218	1	160	1	2.0	257	217
SA160A	178	197	1	160	1	2.0	259	196
SA170	189	231	1	170	1	1.7	304	230
SA170A	189	209	1	170	1	0.1	275	208

**Notes:**

- $V_{BR}$  measure after  $I_T$  applied for 300us,  $I_T$ =square wave pulse or equivalent.
- Surge current waveform per Figure. 3 and derate per Figure. 2.
- For bipolar types having  $V_{WM}$  of 10 volts and under, the  $I_D$  limit is doubled.
- All terms and symbols are consistent with ANSI/IEEE C62.35.

PACKAGE OUTLINE DIMENSIONS

**DO-204AC (DO-15)**

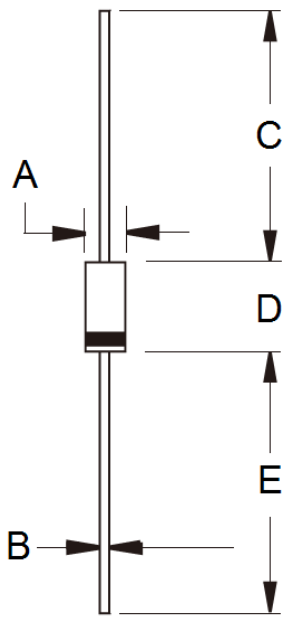

DIM.	Unit (mm)		Unit (inch)	
	Min	Max	Min	Max
A	2.60	3.60	0.102	0.142
B	0.70	0.90	0.028	0.035
C	25.40	-	1.000	-
D	5.80	7.60	0.228	0.299
E	25.40	-	1.000	-

MARKING DIAGRAM



- P/N = Specific Device Code
- G = Green Compound
- YWW = Date Code
- F = Factory Code

## Notice

Specifications of the products displayed herein are subject to change without notice. TSC or anyone on its behalf, assumes no responsibility or liability for any errors inaccuracies.

Information contained herein is intended to provide a product description only. No license, express or implied, to any intellectual property rights is granted by this document. Except as provided in TSC's terms and conditions of sale for such products, TSC assumes no liability whatsoever, and disclaims any express or implied warranty, relating to sale and/or use of TSC products including liability or warranties relating to fitness for a particular purpose, merchantability, or infringement of any patent, copyright, or other intellectual property right.

The products shown herein are not designed for use in medical, life-saving, or life-sustaining applications. Customers using or selling these products for use in such applications do so at their own risk and agree to fully indemnify TSC for any damages resulting from such improper use or sale.