

DA7212 Ultra Low Power Codec and Power Commander™ GUI Software

Introduction

The DA7212 Evaluation Board has been designed to allow measurement and evaluation of the DA7212 device. All Audio Codec functionalities are self-contained within the Evaluation Board (EVB).

The EVB is supplied with a USB memory stick containing various documents and a GUI to allow the user to control the DA7212.

The GUI is called Power Commander™. It uses a simple graphical interface, allowing the DA7212 to be controlled via a USB port of a PC.

The EVB has a number of jumper links to enable the user to change the system configuration and to allow him to make appropriate measurements, although, in reality, few jumper links are required to be altered for standard operations of the DA7212.

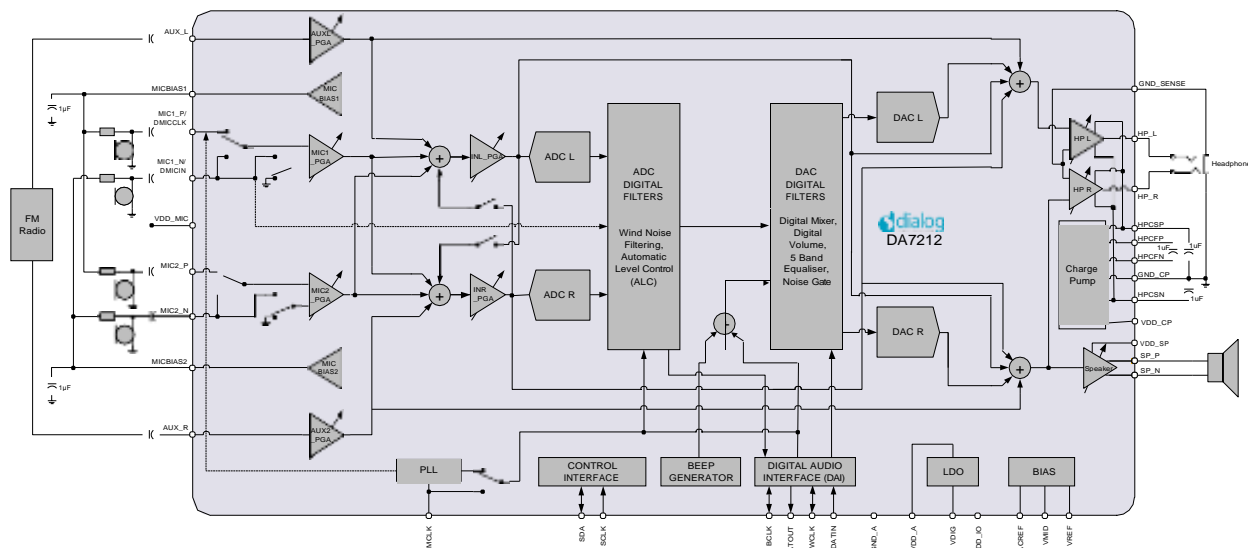

Figure :1 DA7212 Block Diagram

Table of Contents

SUMMARY	3
HARDWARE	4
Power Supplies	6
Audio Connections	7
Jumpers Link Positions and Button Settings	8
CONTROL SOFTWARE	11
Installation	11
Control Panel	13
Status and Controls	14
Control Interface	17
Codec Config Page	18
DAI and PLL Page	19
Analogue Inputs	20
Analogue Outputs	21
Mixers	22
ADC Control	23
DAC Control	24
ALC Control	25
Tone Gen	26
Codec Registers	27
TROUBLESHOOTING	28
Software Issues	28
Hardware Issues	28
APPENDIX A – REGISTER TEXT FILE	30
APPENDIX A – SOCKETED MINIBOARD (169-01-A)	33
REVISION HISTORY	34

Summary

This document provides some useful information to the user about the EVB and the GUI to allow testing and evaluation of the DA7212 Ultra Low Power Codec.

The hardware solution is based upon two PCBs:

- "EVALUATION MOTHERBOARD 170-03-A"
- "CUSTOMER REFERENCE BOARD 169-02-A" (DA7212 mini board)

The GUI, called Power Commander™, requires a PC operating Windows 2000/XP/Vista/Windows 7 with a USB1.1 or USB2 interface.

To run Power Commander™ under Windows Vista, set the default installation location to „C:\Dialog Semiconductor\“.

Note that Dialog recommends connecting the EVB to a 500 mA capable USB port as we cannot guarantee that a USB hub (set to 100 mA) is sufficient to operate it correctly.

See the section on Power Supplies below.

The GUI allows the user to: (i) configure the DA7212 using one of the several pre-loaded initialisation files (i.e. start-up sequences) available; (ii) write and read operations to all control registers; and (iii) monitor of device status.

Hardware

The DA7212 Evaluation Board consists of two boards:

A daughterboard containing the DA7212, and the essential external components. This board could also be used in standalone or as a module for a customer development platform.

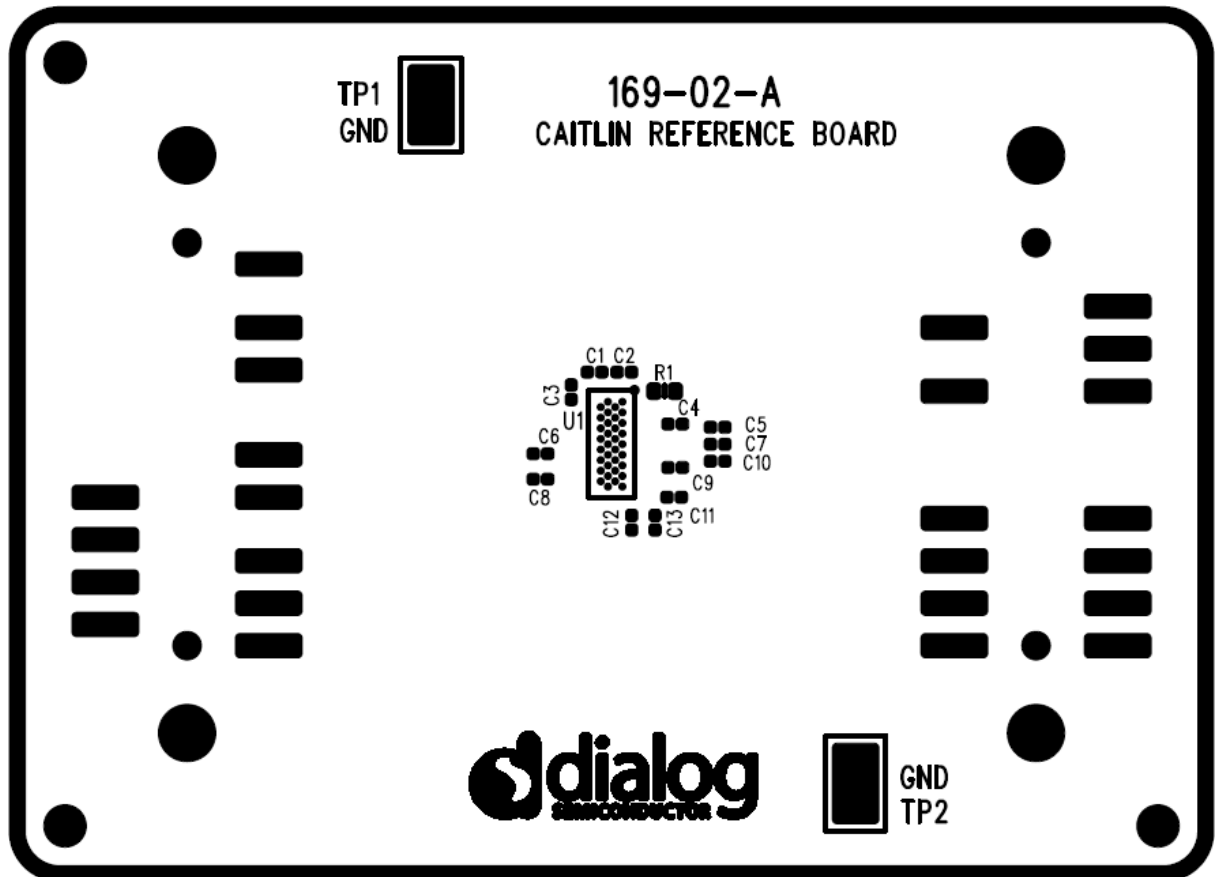

Figure 2: DA7212 Mini Board

Note a socketed mini board (169-01-A) is also available. See appendix B for more information.

A motherboard containing many circuit blocks that allows for flexible configuration and provides test access to the DA7212. It includes:

- a. USB Interface with Control Interface level shifters
- b. 1x audio optical input/output interfaces (with selection matrix)
- c. USB reset and 3.3V reset switches
- d. headphone output
- e. line out outputs
- f. auxiliary inputs
- g. analogue/digital microphone inputs
- h. master clock input
- i. power supply inputs (VBAT, GND)

A USB-I2C bridge is used for communication with the device, and there are a number of external active components to reduce the requirement for external circuitry.

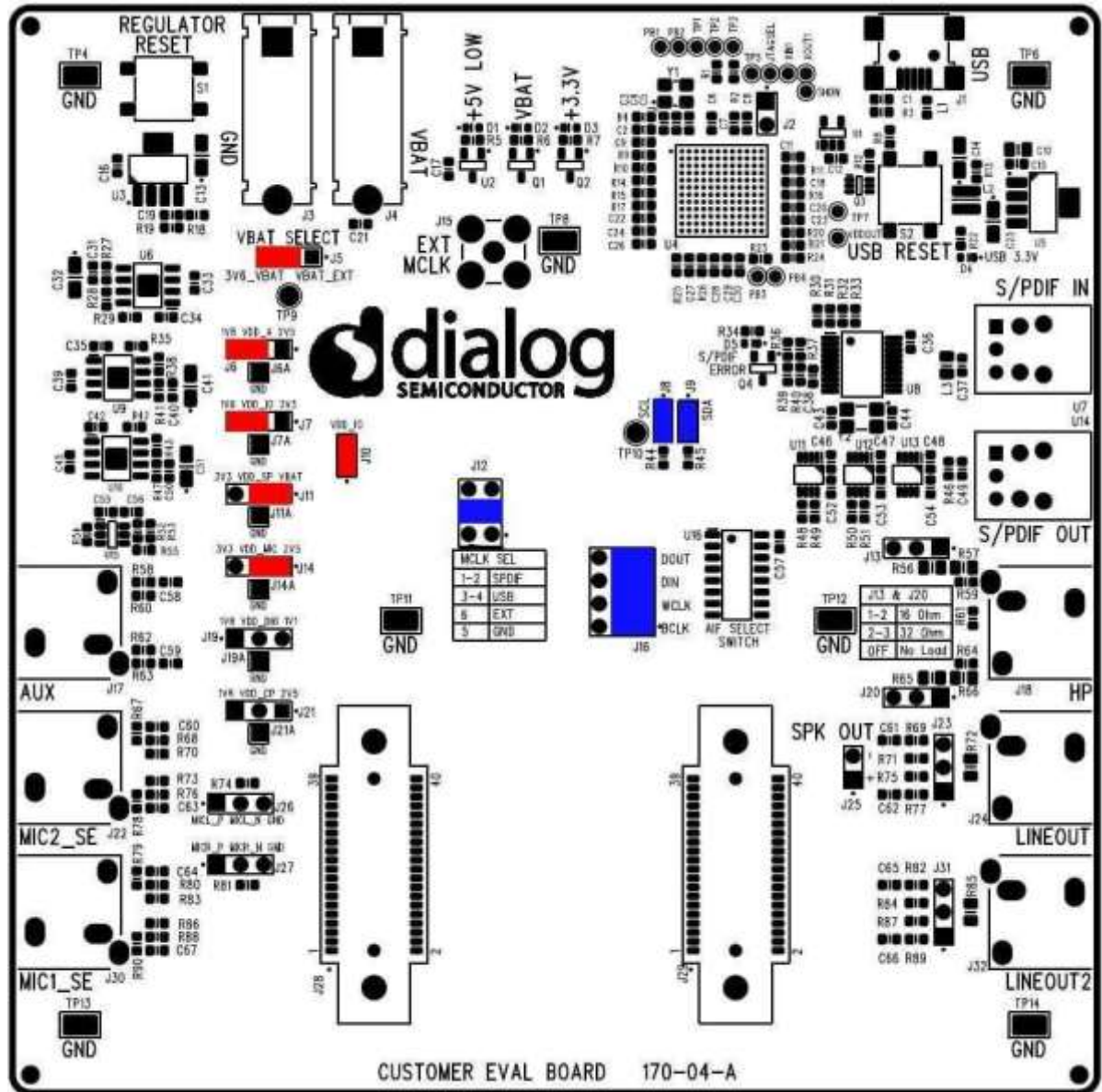
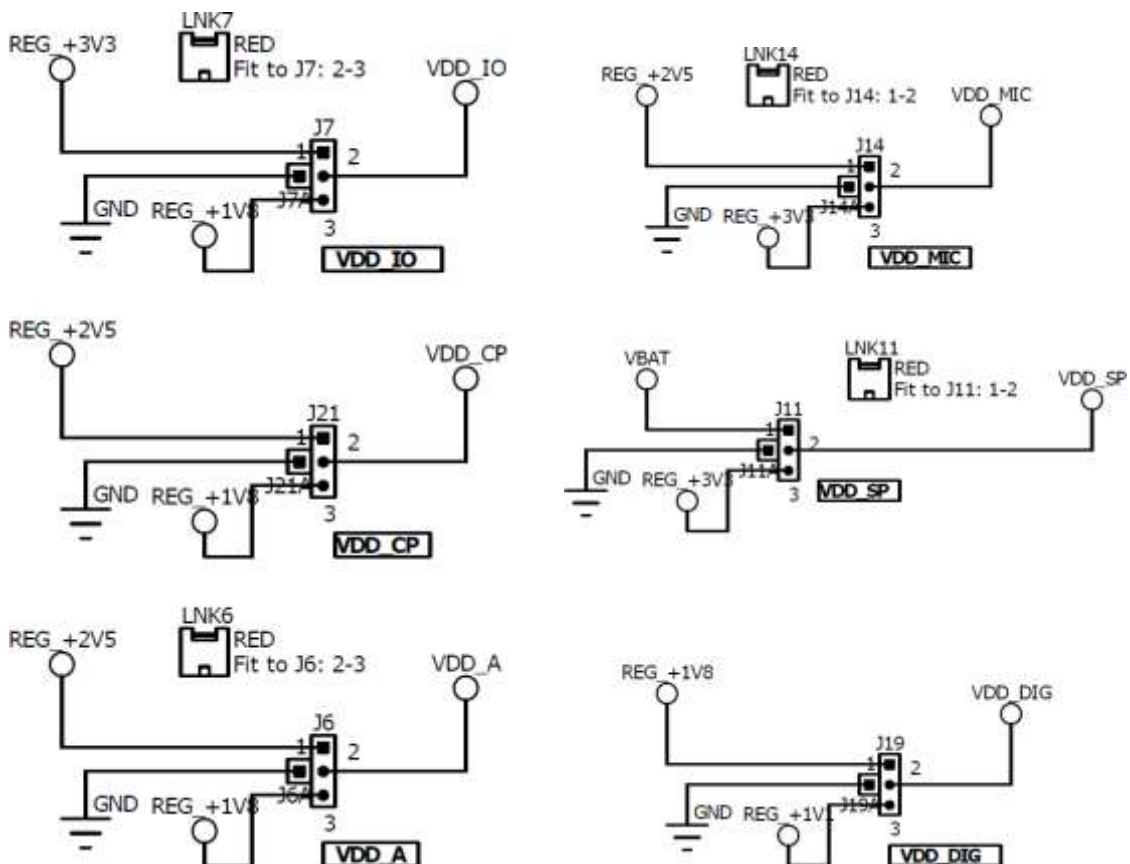

Figure 3: Mother Board – Default Jumper positions shown in Red (power) and Blue (signal)

Note: The EVB has been configured by default to work from the mother board’s on-board regulators.

Power Supplies

The DA7212 EVB is powered when a USB cable is connected to J1 (+5V_USB). With default jumper settings (J6, J7, J11, J14 and J19, J21), the DA7212 device on the daughterboard is powered from the on-board regulators.



As DA7212 supports a wide supply range the jumper configuration allows the user to select one of two on-board supplies for each supply by connecting the jumper link between pins 1&2 or 2&3 of the jumper. For maximum flexibility the jumper link can be removed and a voltage can be supplied directly onto pin 2 of the jumper with a ground connection connected to the A pin of the jumper. Current measurements on individual supplies can also be performed by connecting an ammeter between the supply and pin2 of the jumper.

Note: As VDD_IO supplies the IO voltage for the USB interface and level translators jumper J10 has been provided for current measurements on this supply of the DA7212 device. For current measurements on VDD_IO remove the jumper link and insert an ammeter between pins 1 & 2 of J10.

Note: VDD_CP and VDD_DIG are not used in DA7212 and the jumper link should be left unpopulated.

Audio Connections

Connector	Name	Function
J17	AUX	Stereo single-ended auxiliary input
J30	MIC1_SE	Stereo single-ended microphone input (connects to MIC1_P and MIC2_P)
J22	MIC2_SE	Stereo single-ended microphone input (connects to MIC1_N and MIC2_N)
J26		Mono differential microphone input Pin 1: MIC1_P Pin 2: MIC1_N Pin 3: GND
J27		Mono differential microphone input Pin 1: MIC2_P Pin 2: MIC2_N Pin 3: GND
U7	S/PDIF IN	Digital optical input
U14	S/PDIF OUT	Digital optical output
J18	HP	Stereo single-ended headphone output
J24	LINEOUT	Differential line output (AC coupled, use J25 for speaker)
J23		Differential line output (AC coupled, use J25 for speaker) Pin 1: LINE_P Pin 2: GND Pin 3: LINE_N
J25		Differential speaker output (DC coupled) Pin 1: SP_P Pin 2: SP_N
J32	LINEOUT2	Unused
J31		Unused

Table 1 170-04-A Audio Connectors

Jumpers Link Positions and Button Settings

Jumper number	Position	Function
J3 & J4		External VBAT and GND connection
J5	1-2, (default)	VBAT select: VBAT is generated from an on-board regulator supplied from the USB
	2-3	VBAT select: VBAT is supplied from J3&J4
J6	1-2, (default)	Connects VDD_A from onboard 1.8V supply
	2-3	Connects VDD_A from onboard 2.5V supply
	A	GND connection for connecting external supply between pin 2 and A
J7	1-2, (default)	Connects VDD_IO from onboard 1.8V supply
	2-3	Connects VDD_IO from onboard 3.3V supply
	A	GND connection for connecting external supply between pin 2 and A
J8	On, (default)	Connects USB I2C SCLK to device
J9	On, (default)	Connects USB I2C SDATA to device
J10	On, (default)	Connects VDD_IO to the DA7212 device.
J11	1-2	Connects VDD_SP from onboard 3.3V supply
	2-3, (default)	Connects VDD_SP from VBAT
	A	GND connection for connecting external supply between pin 2 and A
J12	1-2	MCLK comes from the SPDIF interface
	3-4, (default)	MCLK comes from the USB interface
	5	GND pin
	6	External MCLK pin, an external MCLK can be connected between pins 5

		and 6.
J13	1-2	Inserts a 16ohm load across the left headphone output for test purposes
	2-3	Inserts a 32ohm load across the left headphone output for test purposes
J14	1-2	Connects VDD_MIC from onboard 3.3V supply
	2-3, (default)	Connects VDD_MIC from onboard 2.5V supply
	A	GND connection for connecting external supply between pin 2 and A
J15		Allows connection of an external MCLK using an SMB connector. J12 should have it's jumper link removed when using this option.
J16	1-2, (default)	Connects the SPDIF/USB BCLK to the DA7212 device
	3	GND for connecting BCLK to/from an external source between 2-3 (for example Audio Precision PSIA cable)
	4-5, (default)	Connects the SPDIF/USB WCLK to the DA7212 device
	6	GND for connecting WCLK to/from an external source between 5-6 (for example Audio Precision PSIA cable)
	7-8, (default)	Connects the SPDIF/USB DIN to the DA7212 device
	9	GND for connecting DIN from an external source between 8-9 (for example Audio Precision PSIA cable)
	10-11, (default)	Connects the SPDIF/USB WCLK to the DA7212 device
	12	GND for connecting DOUT to an external source between 11-12 (for example Audio Precision PSIA cable)
J19	1-2	Not Used
	2-3,	Do not connect for DA7212
	A	
J20	1-2	Inserts a 16ohm load across

		the right headphone output for test purposes
	2-3	Inserts a 32ohm load across the right headphone output for test purposes
J21	1-2, (default)	Not Used
	2-3	Do not connect for DA7212
	A	
S1		Regulator Reset button: Resets the 3.3V, 2.5V, 1.8V and 1.1V regulators
S2		USB Reset button: Resets the USB sub system

Table 2: 170-04-A Jumpers Link Positions and Button Settings

Control Software

Installation

From the USB memory stick provided with the EVB box, run the „setup.exe“ file (DA7212_USB\DA7212 GUI\setup.exe).

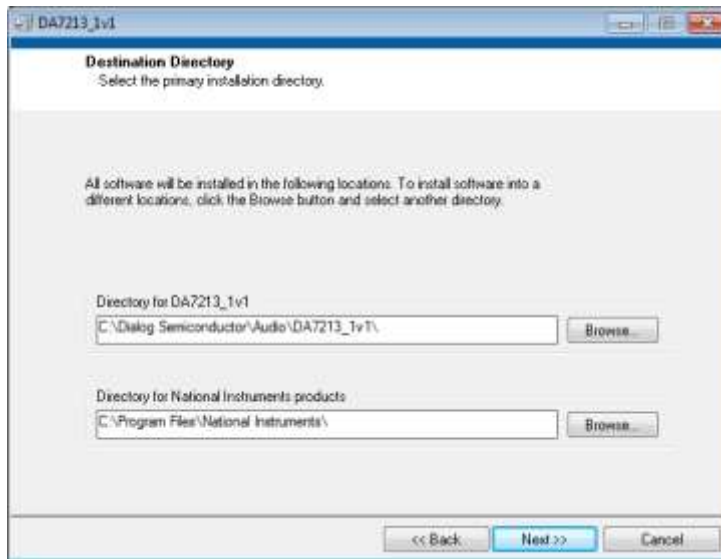

Click “Next>>”.

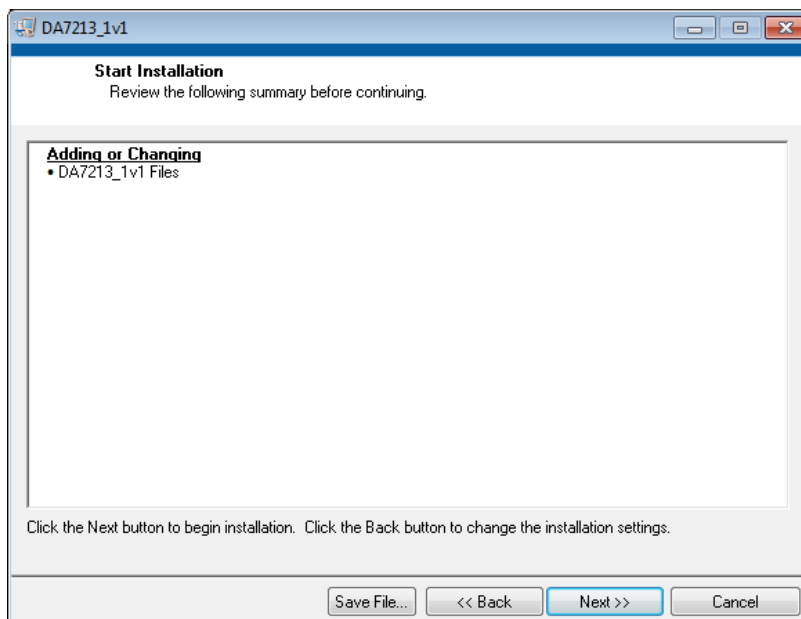

Click “Next>>”.

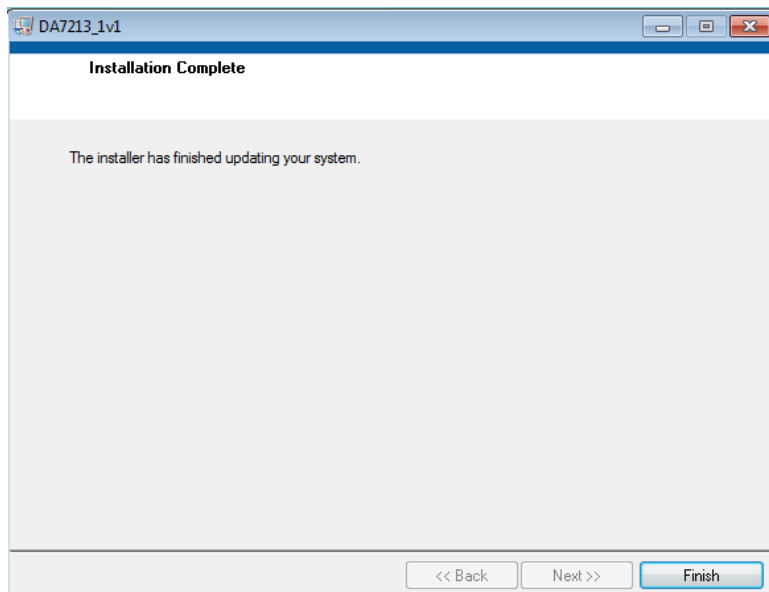

Click "Finish".

You may need to restart your computer; in this case a pop up window will appear asking you to do so.

Once your computer has restarted, plug the USB cable to the EVB and Windows should detect the USB device and automatically install the driver. If not, the driver is located on this DA7212 USB stick

Control Panel

Run the DA7212 program by clicking the shortcut on the appropriate item in the Start menu. The best setting for the PC display size is 1024x768 pixels or above. Font size on the PC display should be Normal (95dpi). It is important to note that a display size other than the recommended setting may affect the way in which the panels appear.

The following screen appears, with the “USB OK?” LED lit if the USB interface is correctly connected and operational.

To start the device, plug in the USB cable.

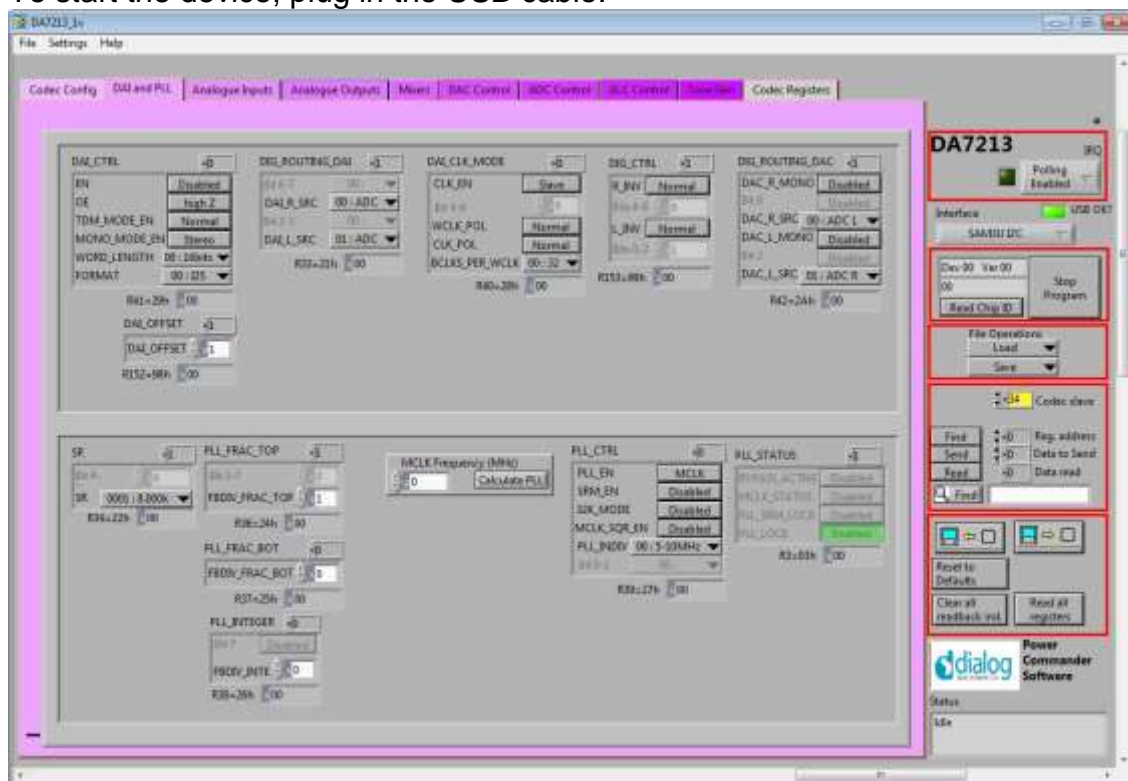

Figure 4 Initial Interface

If the Reset LED is blinking yellow, it indicates that the device is not yet communicating via the I2C interface. See Troubleshooting for more details.

Status and Controls

Polling Enabled

BY default the current page contents is updated via polling the I2C interface. If disabled, these readbacks are suppressed. This is used to force the communication over the bus to be silent. If this is set to automatic, the program will only poll the device while the application is the topmost window. If obscured by another program or window, polling will be disabled.

LED

If the device is active this LED is green, or red if inactive.

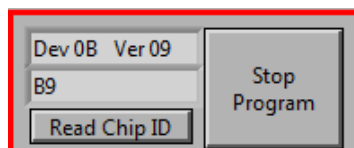

This indicates the device version when the device is active. When inactive, version status will not be correct.

Stop Program

This terminates the program. If there are unsaved changes, a dialog box is displayed.

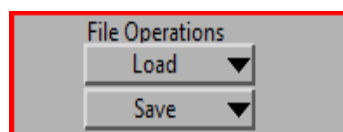

Load Loads previously saved text files, send all Registers and read back all registers. “Load” opens a dialog box to select, view, copy or re-name a file.

Load Codec file opens a dialog box to allow selection of a codec setup file in the “\Codec Setups” directory.

Save Saves current panel state to a text file. Selecting “Save Codec file..” saves the codec registers in a slightly different format. Selecting “Register Dump” option saves current register values to the text file. See Appendix A.

Note: Difference between “Save” and “Register Dump” is that the “Save” dumps the contents of all panel controls to the file (a save state operation); whereas, “Register Dump” reads the device contents (including status registers) into the file. Note that some codec registers do not have readback capability.



Interface Selects between USB I2C control and offline mode. Switching to offline, then back to USB reinitialises the USB interface.

USB OK? Indicates that the USB is OK and communicating.

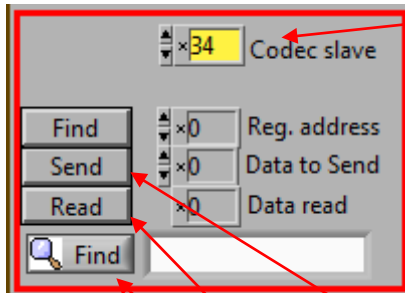

Slave Address

Sets slave address of device. This affects all I2C communications.

The codec slave addresses for DA7212 is 0x34. *Note that this is the 8bit value (34h for Write, 35h for Read).*

Send Sends a single byte data to I2C device using Slave Address, Register Address and Data to Send.

Read Reads single byte data from I2C device using Slave Address and Register Address.

Find Finds a control matching a full or partial register name, a control bit name, a register number (e.g. R23 or 17h). Pressing “Find” repetitively will step through all matching items.

Note: If Device Address does not match the port numbers on the device, this can be used to control/read any other device on the I2C bus.

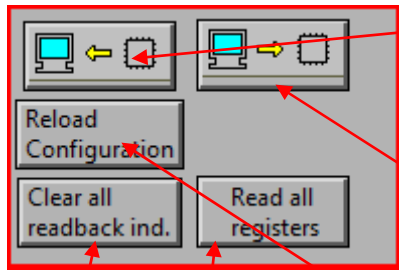

Synchronise Panel from Device
 Reads all the register contents of the device and updates the panel to match.

Synchronise Device from Panel
 Writes all the device registers to match the panel. (Refresh operation)

Reload Configuration
 Resets registers to values specified in configuration file for the PMIC section and default values for the codec.

Clear all I2C readback indicators

Sets all readback indicators to 0.

Read All Registers

Reads all registers, comparing with the panel controls.

Control Interface

The Codec Config, DAI and PLL, Analogue Inputs, Analogue Outputs, Mixers, DAC Control, ADC Control, ALC control and Tone Gen pages all have the same format.

Each register cluster comprises a control with a mixture of Boolean toggle buttons, multi-value ring controls, or slide controls, as well as a hexadecimal indicator showing the total equivalent register value and a readback indicator showing the current register settings. The Event Register is labeled with a Register number in decimal and its hexadecimal equivalent.

The Readback indicator readings can be switched individually to decimal, octal, hexadecimal or binary by clicking on the “x”, or they may all be changed at once between Hex and Binary by the “View>Binary Indicators” menu item.

Codec Config Page

The Codec Config page allows access to the System Controller as well as some basic system settings such as the references, IO levels and digital LDO. To use the System Control panel (de)select the blocks as required for the inputs and outputs and click the Submit button to apply the changes. If no blocks are active then the System Active panel can be used to disable the on-chip oscillator and put DA7212 into an ultra-low power standby state. The CIF CTRL panel can be used to reset the chip and return all the registers to their hardware defaults.

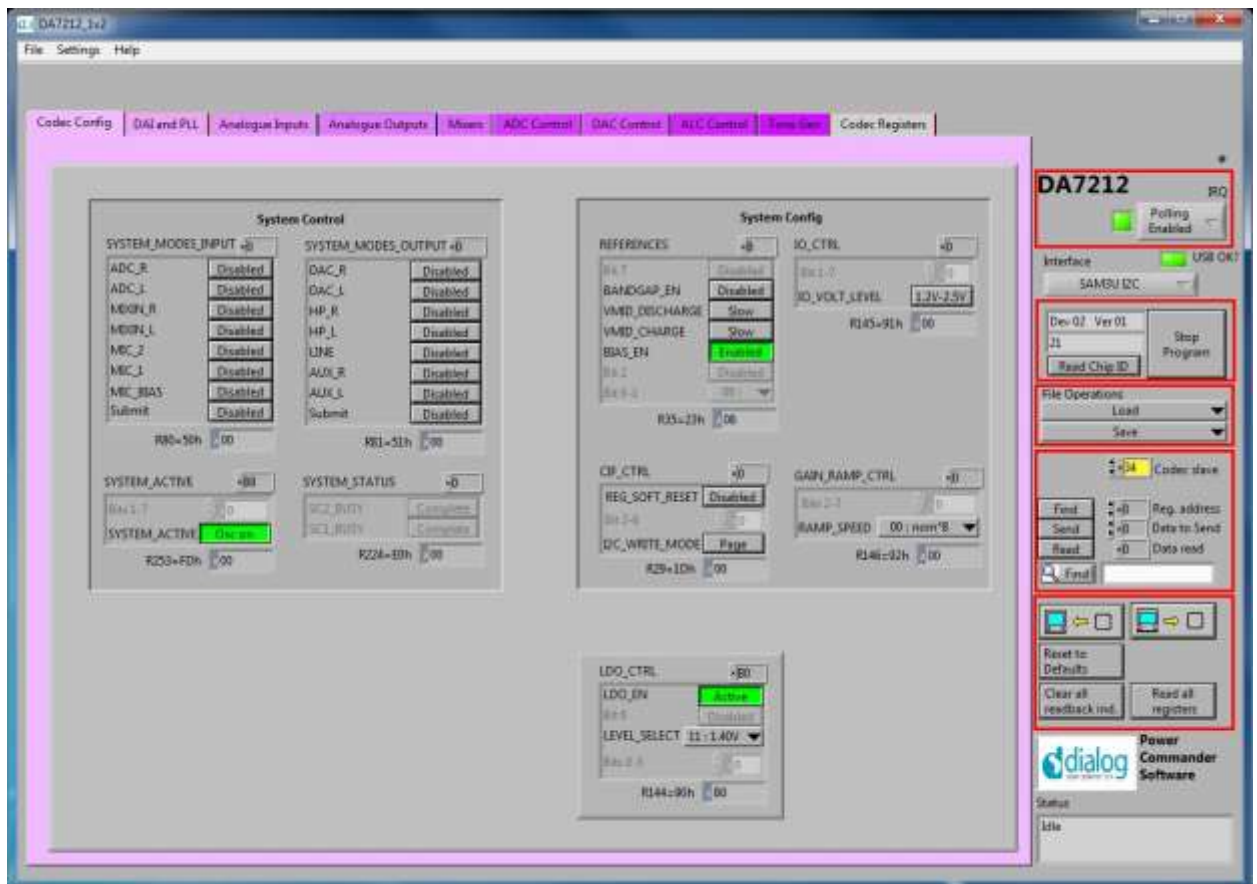

DAI and PLL Page

The DAI and PLL page allows control of the digital audio interface and phase-locked loop. The DAI CTRL panel sets the format on the DAI and the DAI CLK MODE panel sets the master/slave mode as well as the clock polarity and number of BCLKS per WCLK. The DIG ROUTING DAI panel selects the data source for the DAI and DIG ROUTING DAC selects the data source for the DAC.

The PLL Control panel contains all the settings for the PLL and on-chip clocking. The SR panel sets the sample rate being used. The PLL CTRL panel sets the input clock rate, whether the PLL is enabled and whether sample rate matching (SRM) is required to track the DAI in slave mode. If the PLL is required, the three FB DIV panels control the value of the feedback divider. The required values can be calculated using the DA7212 PLL Calculator spreadsheet, or they can be determined automatically by entering the supplied MCLK frequency and pressing the Calculate PLL button. The current status of the PLL is shown in the PLL STATUS panel. The PC COUNT panel controls the behavior of the internal program counter.

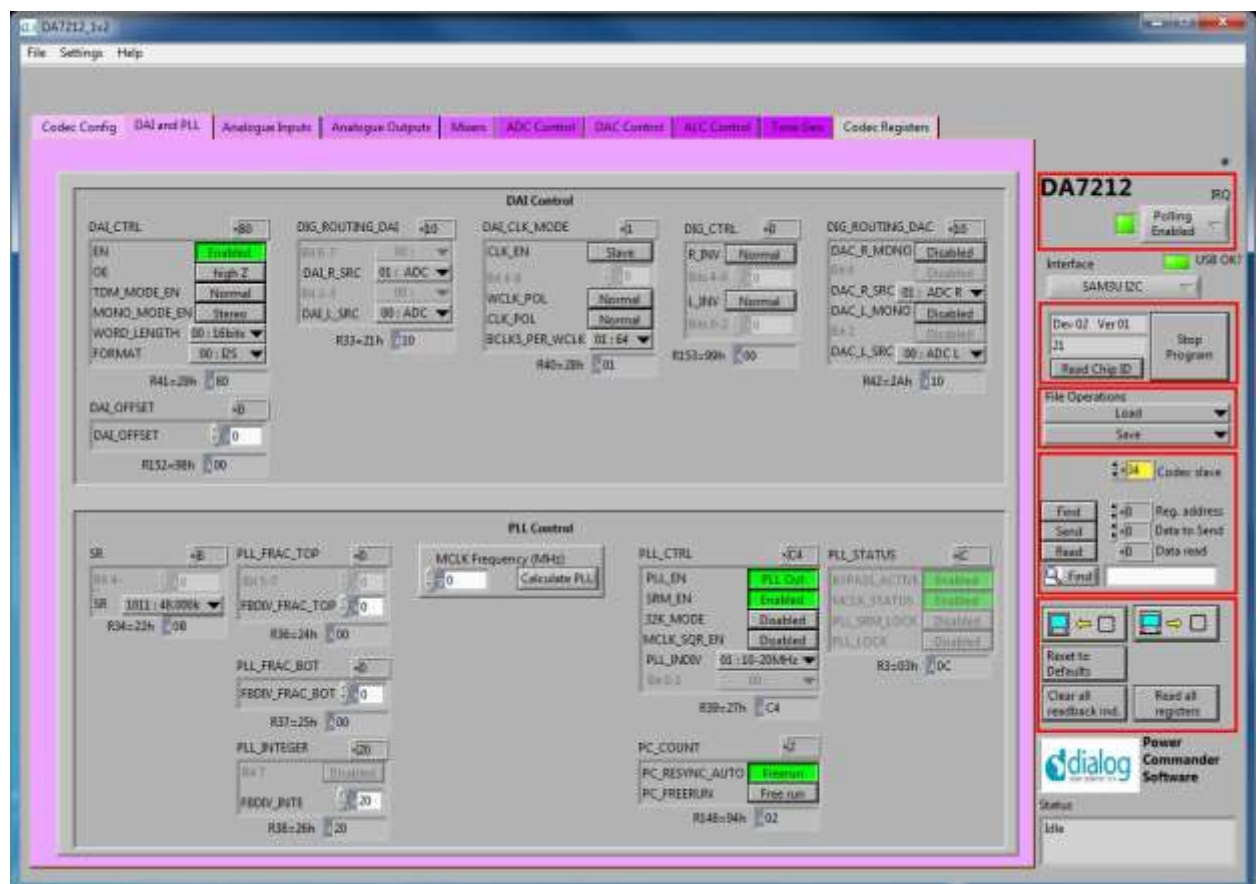

Analogue Inputs

The Analogue Inputs page controls the input amplifiers and microphone biases. Each of the GAIN panels sets the target gain for the amplifiers, and the GAIN STATUS shows the currently active gain setting. Each of the CTRL panels sets the enable, mute, and gain change behavior (ramped or zero-crossed) for the amplifiers. The MIC CTRL panels allow selection of single-ended or differential input signal. The MICBIAS CTRL panel enables and sets the output level for the microphone bias outputs. The MIC CONFIG panel sets the clock and data format when digital microphones are used.

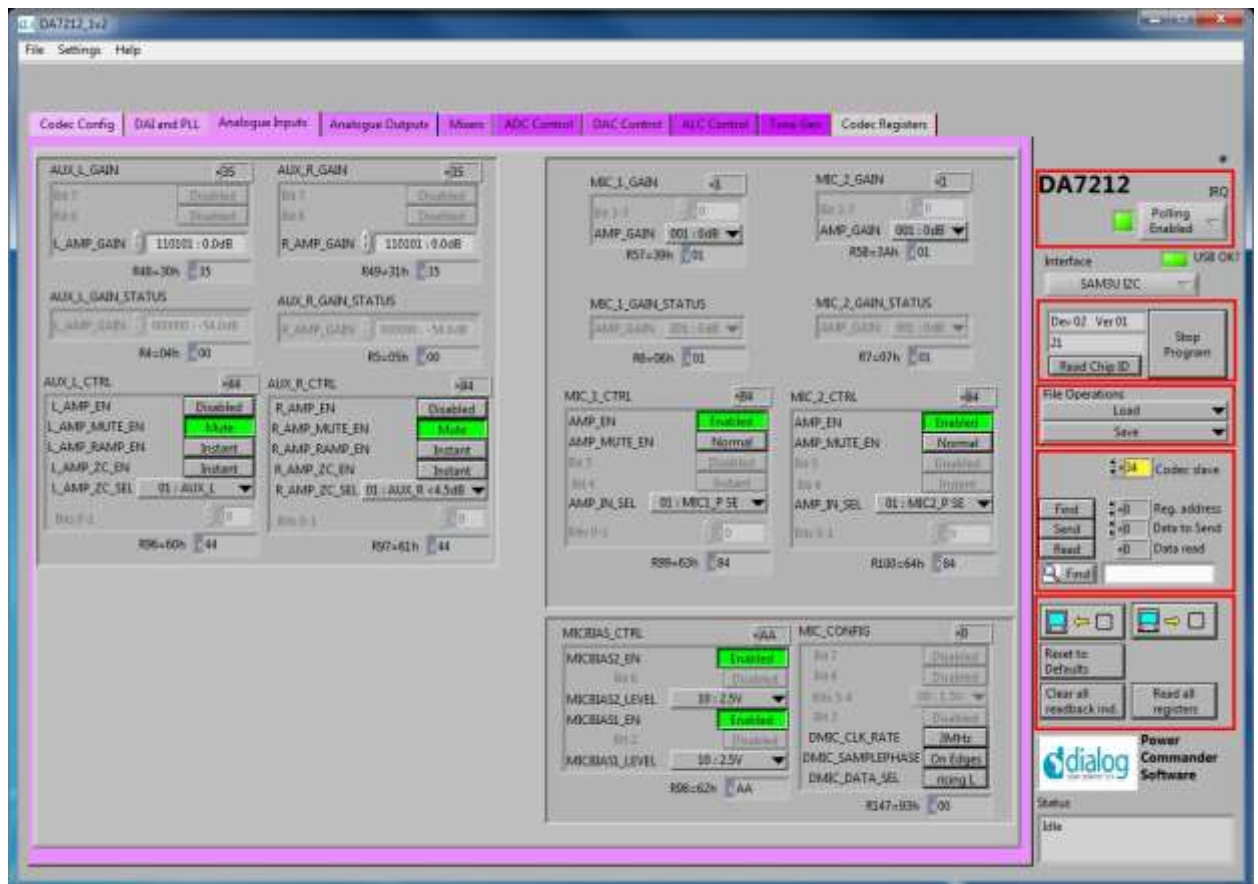

Analogue Outputs

The Analogue Outputs page controls the headphone and line (speaker) amplifiers as well as the charge pump for the headphone supplies. The GAIN, GAIN STATUS and CTRL panels behave as for the Analogue Inputs page. The Charge Pump Control controls the mode and switching behavior of the charge pump as explained in the datasheet.

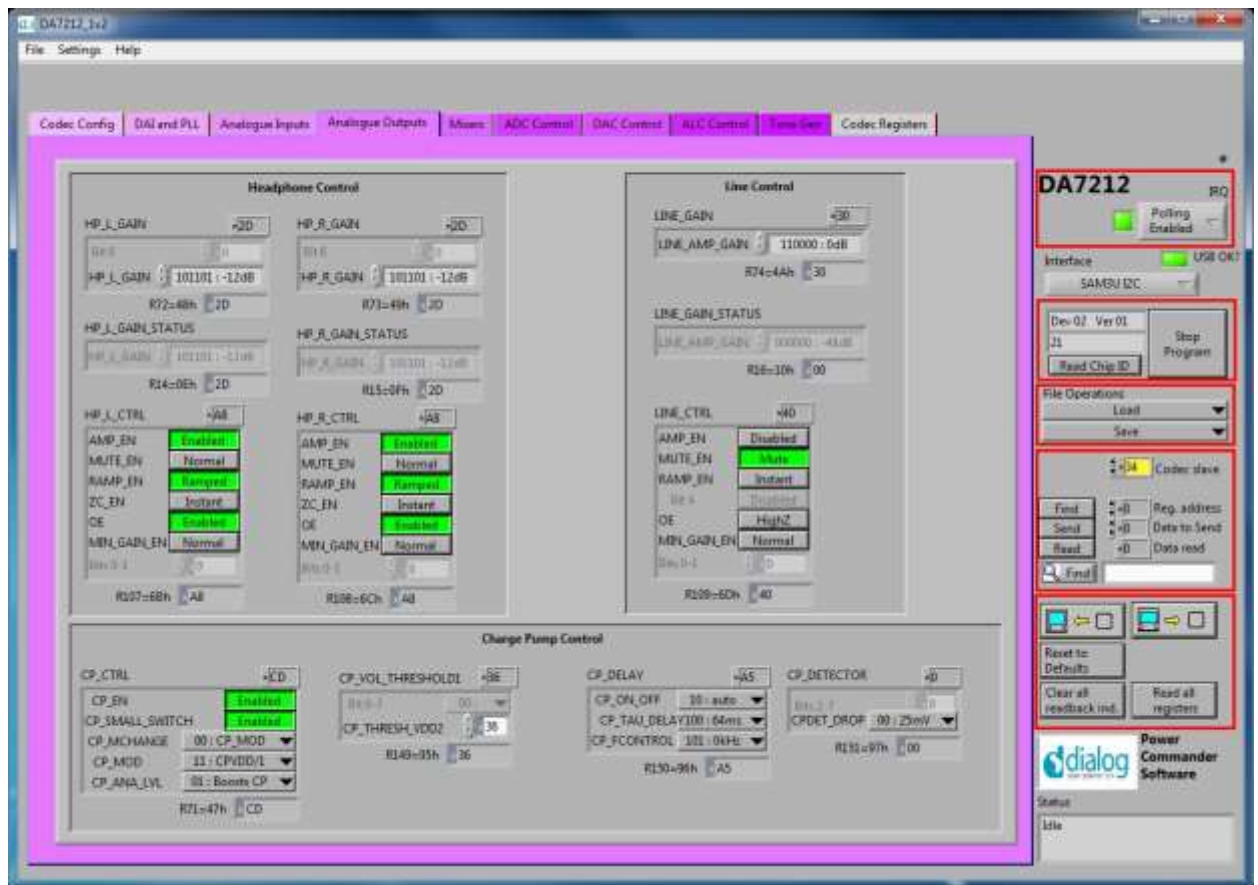

Mixers

The Mixers page controls the behavior of the analogue input and output mixers. The GAIN, GAIN STATUS and CTRL panels behave as for the Analogue Inputs page. The MIXOUT CTRL panel also enables the Softmix feature to ramp in/out the the select inputs. The SELECT panels controls which inputs are routed to each of the four mixers.

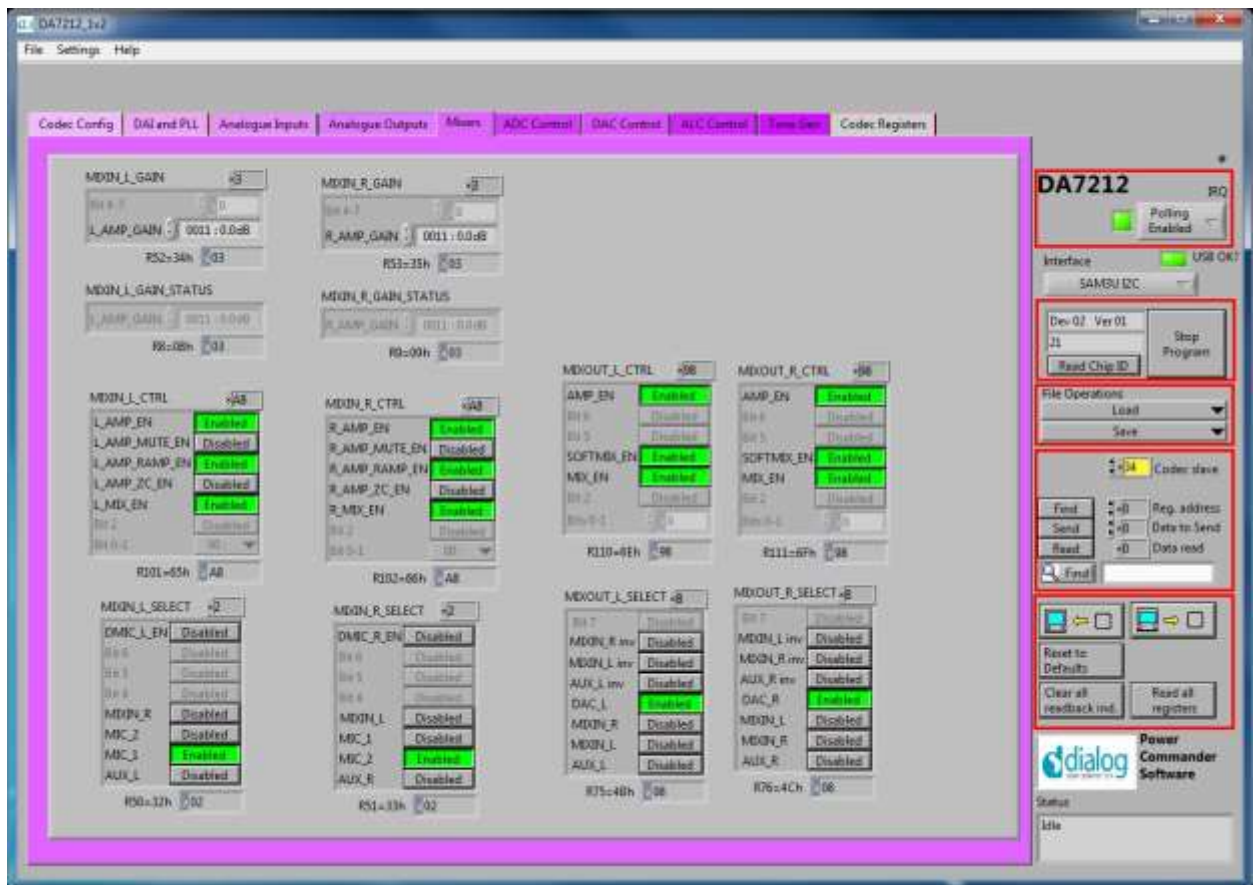

ADC Control

The ADC Control page enables the ADC, sets the digital gain applied after the ADC and controls the behavior of the high-pass filter.

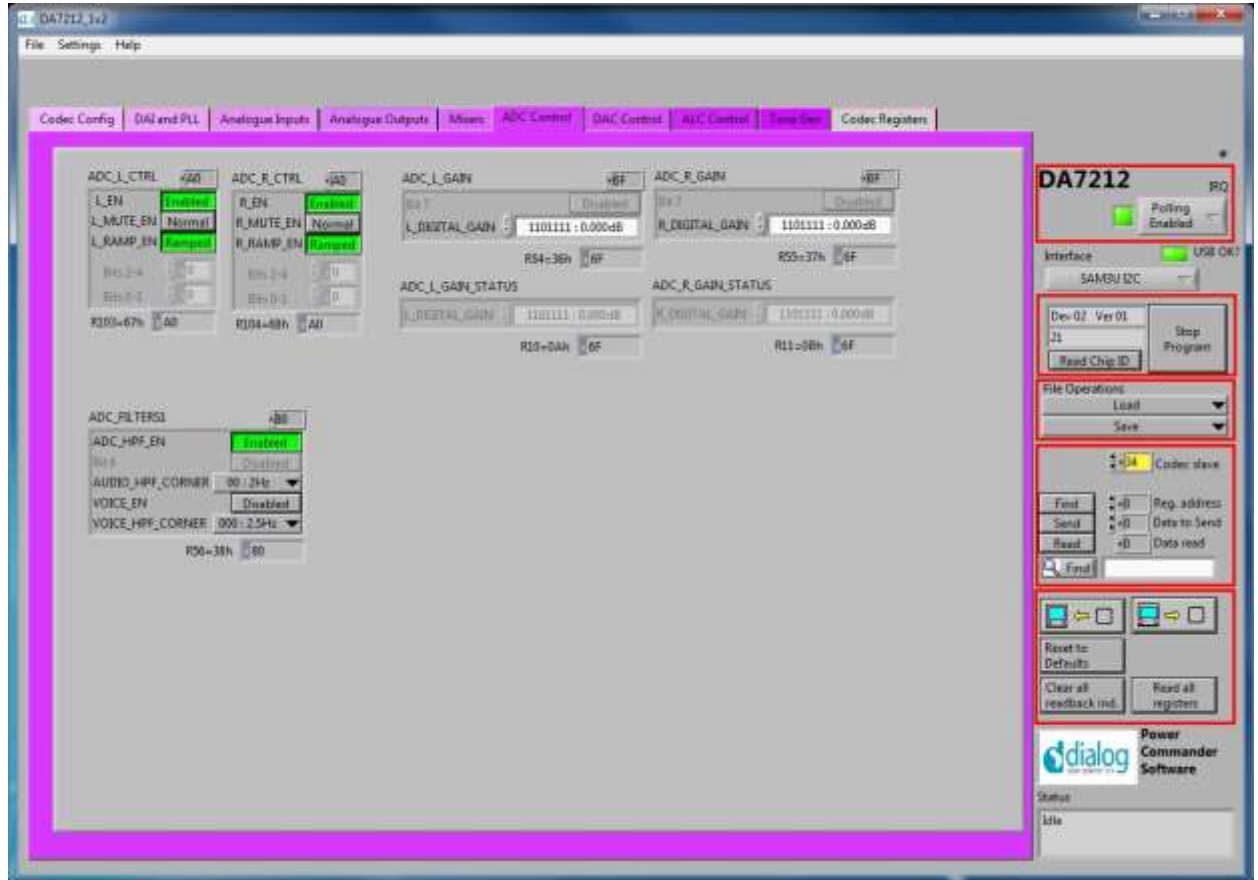

DAC Control

The DAC Control page controls the DAC, the DAC filters and the DAC noise gate. The DAC FILTERS panels control the high-pass filter as well as the 5-band EQ filter. There is also an option to apply a soft mute to the DAC input signal. The DAC NG panels control the behavior of the DAC noise gate in terms of its on and off thresholds, attack/decay rates and hold time.

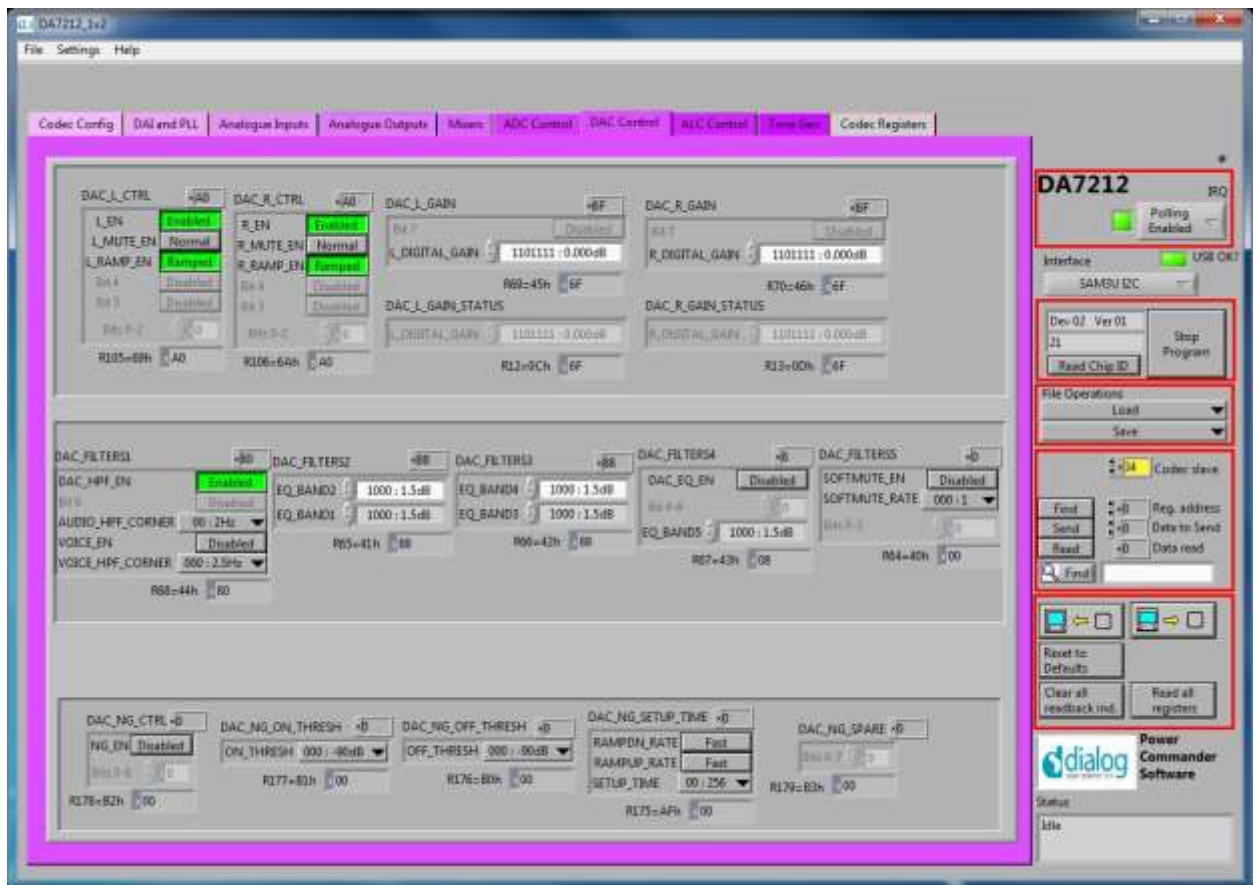

ALC Control

The ALC Control page configures the automatic level control on the record path. The ALC behavior is described in detail in the datasheet.

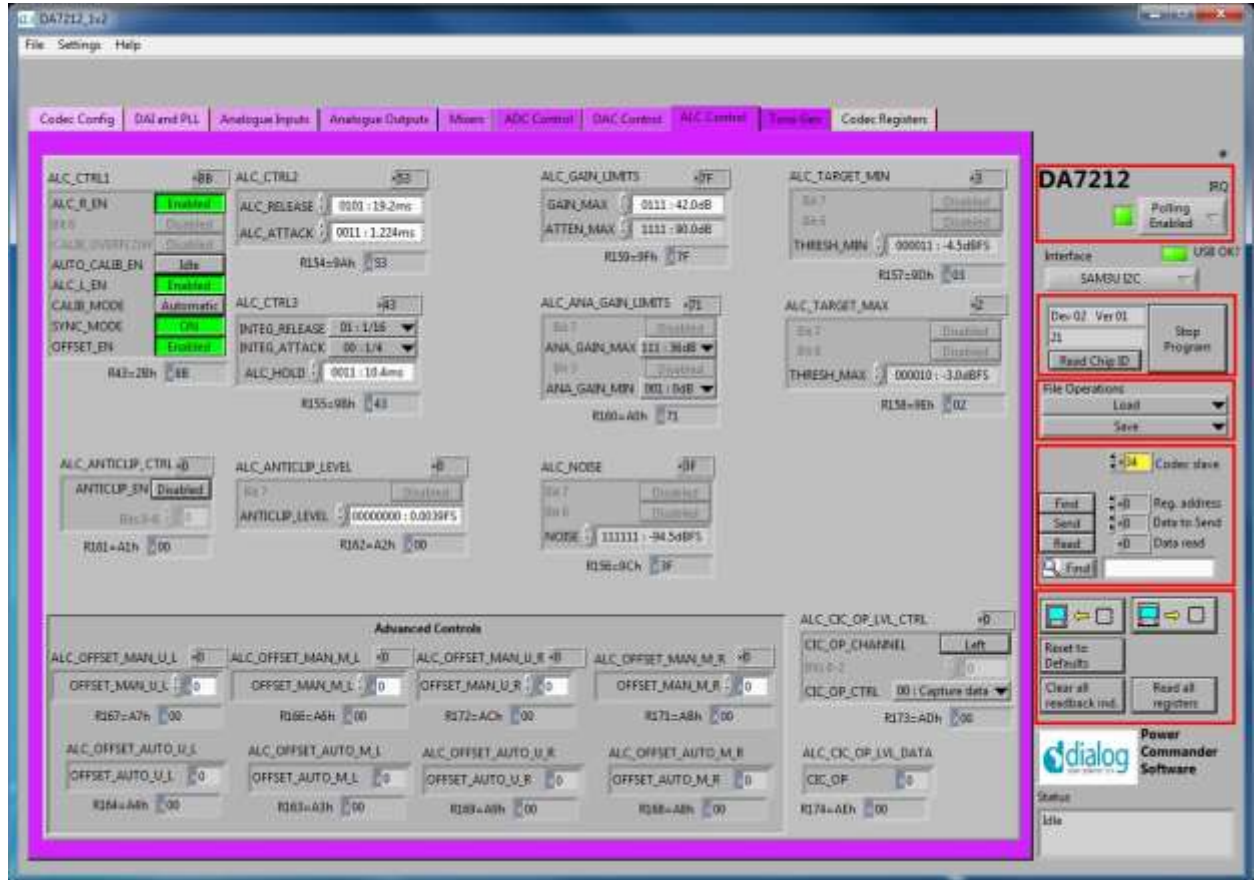

Tone Gen

The Tone Gen page controls the digital tone generator at the input to the DAC. TONE GEN CFG1 panel starts the tone generator and enables a DTMF tone if required. TONE GEN CFG2 panel sets the gain applied to the tone and controls which sine-wave generator is used (or both). The TONE GEN FREQ panels set the frequency for the two generators as described in the datasheet. The DTMF Phone pad panel produces DTMF tones when the buttons are pressed. The TONE GEN CYCLES panel controls how many beeps are produced, and the TONE GEN ON and OFF PER panels control the on and off periods.

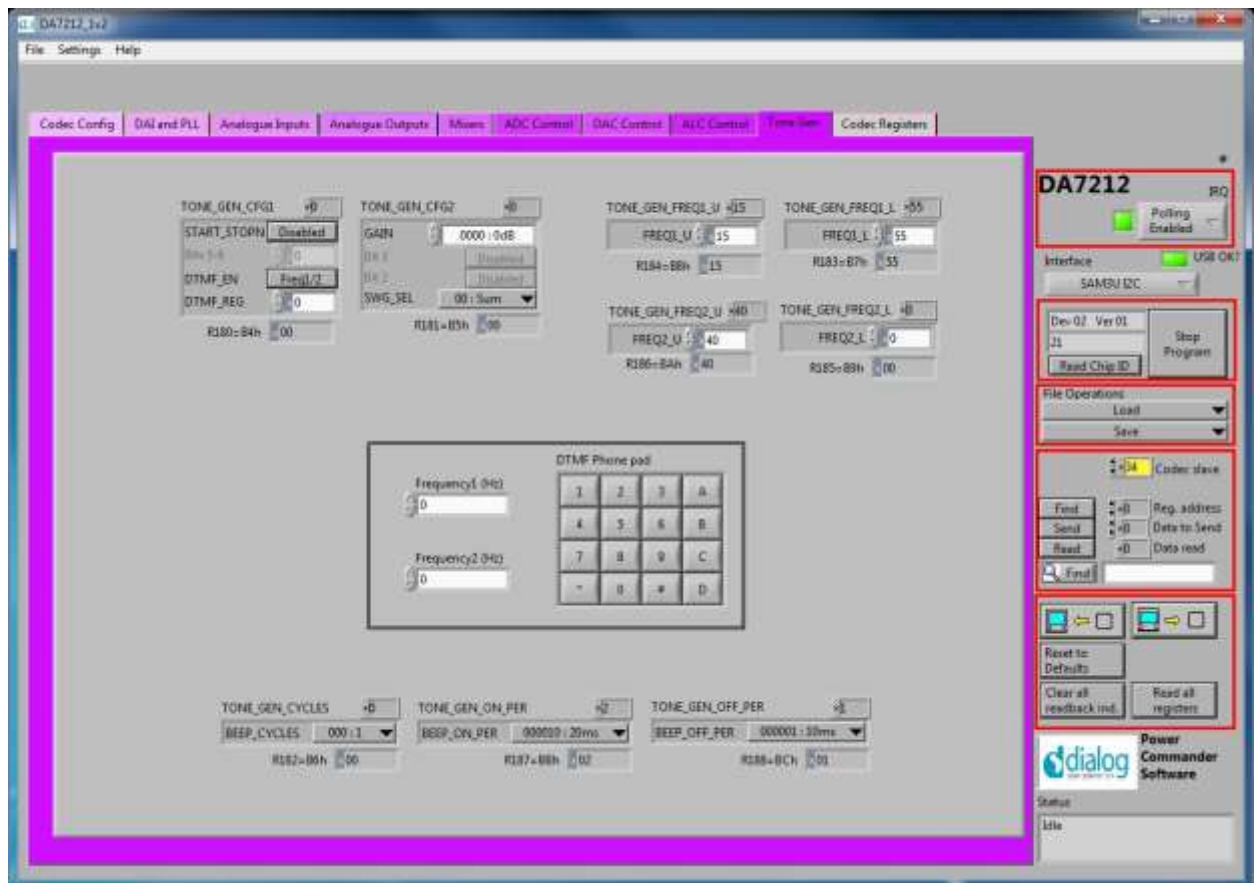

Codec Registers

This page presents the registers in a single table. The table is interactive, both receiving changes made in other controls, and passing values to other controls if changed in the table. In some conditions this register view may be useful.

The screenshot displays the DA7213 software interface. The main window is titled 'DA7213_1.v' and has a menu bar with 'File', 'Settings', and 'Help'. Below the menu bar are several tabs: 'Codec Config', 'DAI and PLL', 'Analogue Inputs', 'Analogue Outputs', 'Mixers', 'DAC Control', 'ADC Control', 'ALC Control', 'Voice Gen', and 'Codec Registers'. The 'Codec Registers' tab is active, showing two main sections: 'Codec Table' and 'Codec Register Map'.

The 'Codec Table' has columns for 'Input', 'Readback', and 'Default'. It lists various inputs from 0x00 to 0x0A, with most default values set to 0x00. The 'Codec Register Map' is a grid with columns for register names and addresses. It includes registers like 0x00, 0x01, 0x02, 0x03, 0x04, 0x05, 0x06, 0x07, 0x08, 0x09, 0x0A, 0x0B, 0x0C, 0x0D, 0x0E, 0x0F, 0x10, 0x11, 0x12, 0x13, 0x14, 0x15, 0x16, 0x17, 0x18, 0x19, 0x1A, 0x1B, 0x1C, 0x1D, 0x1E, 0x1F, 0x20, 0x21, 0x22, 0x23, 0x24, 0x25, 0x26, 0x27, 0x28, 0x29, 0x2A, 0x2B, 0x2C, 0x2D, 0x2E, 0x2F, 0x30, 0x31, 0x32, 0x33, 0x34, 0x35, 0x36, 0x37, 0x38, 0x39, 0x3A, 0x3B, 0x3C, 0x3D, 0x3E, 0x3F, 0x40, 0x41, 0x42, 0x43, 0x44, 0x45, 0x46, 0x47, 0x48, 0x49, 0x4A, 0x4B, 0x4C, 0x4D, 0x4E, 0x4F, 0x50, 0x51, 0x52, 0x53, 0x54, 0x55, 0x56, 0x57, 0x58, 0x59, 0x5A, 0x5B, 0x5C, 0x5D, 0x5E, 0x5F, 0x60, 0x61, 0x62, 0x63, 0x64, 0x65, 0x66, 0x67, 0x68, 0x69, 0x6A, 0x6B, 0x6C, 0x6D, 0x6E, 0x6F, 0x70, 0x71, 0x72, 0x73, 0x74, 0x75, 0x76, 0x77, 0x78, 0x79, 0x7A, 0x7B, 0x7C, 0x7D, 0x7E, 0x7F, 0x80, 0x81, 0x82, 0x83, 0x84, 0x85, 0x86, 0x87, 0x88, 0x89, 0x8A, 0x8B, 0x8C, 0x8D, 0x8E, 0x8F, 0x90, 0x91, 0x92, 0x93, 0x94, 0x95, 0x96, 0x97, 0x98, 0x99, 0x9A, 0x9B, 0x9C, 0x9D, 0x9E, 0x9F, 0xA0, 0xA1, 0xA2, 0xA3, 0xA4, 0xA5, 0xA6, 0xA7, 0xA8, 0xA9, 0xAA, 0xAB, 0xAC, 0xAD, 0xAE, 0xAF, 0xB0, 0xB1, 0xB2, 0xB3, 0xB4, 0xB5, 0xB6, 0xB7, 0xB8, 0xB9, 0xBA, 0xBB, 0xBC, 0xBD, 0xBE, 0xBF, 0xC0, 0xC1, 0xC2, 0xC3, 0xC4, 0xC5, 0xC6, 0xC7, 0xC8, 0xC9, 0xCA, 0xCB, 0xCC, 0xCD, 0xCE, 0xCF, 0xD0, 0xD1, 0xD2, 0xD3, 0xD4, 0xD5, 0xD6, 0xD7, 0xD8, 0xD9, 0xDA, 0xDB, 0xDC, 0xDD, 0xDE, 0xDF, 0xE0, 0xE1, 0xE2, 0xE3, 0xE4, 0xE5, 0xE6, 0xE7, 0xE8, 0xE9, 0xEA, 0xEB, 0xEC, 0xED, 0xEE, 0xEF, 0xF0, 0xF1, 0xF2, 0xF3, 0xF4, 0xF5, 0xF6, 0xF7, 0xF8, 0xF9, 0xFA, 0xFB, 0xFC, 0xFD, 0xFE, 0xFF.

At the bottom of the main window, there are two buttons: 'Refresh Codec table' and 'Read All'. The right-hand sidebar contains a status panel for the DA7213 device, including 'Polling Enabled', 'Interface: SAMSU I2C', 'USB OK!', 'Dev ID: Ver 00', 'Stop Program', 'Read Chip ID', 'File Operations: Load, Save', 'Codec slave', 'Find, Send, Read', 'Reset to Defaults', 'Clear all readback ind.', 'Read all registers', and 'Power Commander Software'.

Troubleshooting

This section is an aid to resolving problems occurring in the previous sections.

Software Issues

The USB device should install without difficulty automatically. Make sure that the installation finds and uses the driver contained in the USB memory stick.

If the program is started before the USB Interface board is plugged in, the program will default to the offline mode. It can be useful to familiarise yourself with the software in a desk environment without the hardware attached. If the board is subsequently attached, move the Interface control to “USB”. Make sure the USB is connected and then restart the program.

The software is optimized for a display screen size of 1024 by 768 pixels or greater, with Fonts set to Normal (96dpi).

There have been reported issues of unpredictable display effects when large fonts (120dpi) are used. This can be changed by right-clicking on the desktop, select Properties. Select the Settings tab, select Advanced, then Normal size from the drop-down box.

If communications are apparently lost, first press the “Start Device” button. This attempts to make the device go active.

Also switching the “Interface mode” to Offline, then back to USB can reinitialize the USB interface. Last resort is to unplug the USB then reconnect. The software will detect this and reinitialize.

Hardware Issues

Most hardware problems can be traced to incorrect jumper positions.

Check carefully jumper positions by comparing them with the default positions on page 7. Use the jumper table details and the board schematic as a guide to the jumper functions and locations.

Selecting USB playback

The dialog DA7212 EVB coupled with the digital IO board allows a number of audio sources to be selected with ease for testing and evaluation. One example is to stream audio from a PC to the EVB over USB, This can easily be done in the following way.



Right click on speaker symbol in task bar, circled in red



Select playback devices

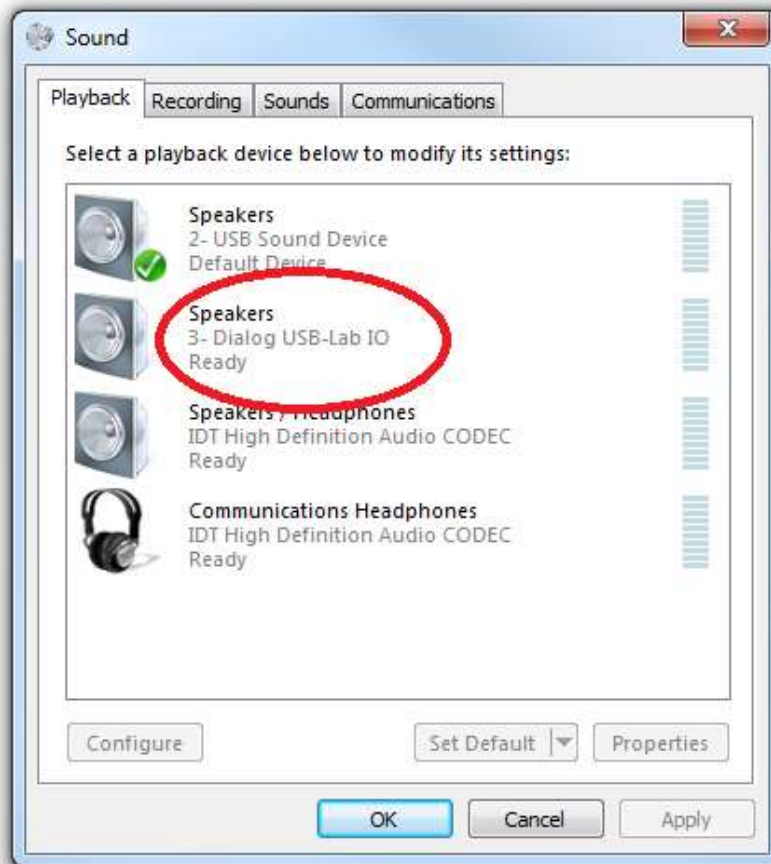

Left click on Dialog US-Lab IO, then select “Set Default” and OK.

Audio played on the PC will now be streamed over USB to the digital IO board for use on the DA7212 board.

Appendix A – Register Text File

The software includes the ability to save and load a text file containing command codes representing the register addresses and data. This file is principally used to save and load setup data, but may also be used to perform a small degree of automation.

Note that at the end of the startup process, initiated by pressing “Start Device”, a file “Host_configuration.txt” is loaded and run to emulate the host processor writing immediately to the device.

If the option “Settings>Reg names in file” is set from the menu, register names, rather than numbers, are used in the file, and the slave address is replaced by the word “CODEC”. This is generally preferable and more readable. Names are defined in the files “Registers_DA7212.h”, and “Hardware_DA7212.h” that reside in the \Data\Drivers directory. Hex codes for slave address and register address are still accepted on reading in the file.

The use of the Save\logtest.txt facility permits register contents to be transferred to the user’s own software. Clicking on Save\logtest.txt brings up the following panel, showing the location and name of the saved file. This is a Register dump of the entire device.

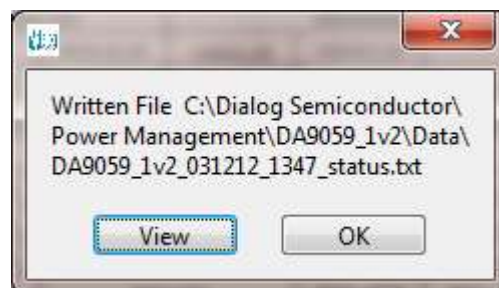

Example message box.

I2C Register Text File Format

The following formats are used for both read and write in the text file.

- Numbers apart from time delays are always expressed in Hex, separated by tabs. The use of “0x” in front of the hex value is optional.
- The first parameter is the device slave address in 8bit format. **OR**
- The first parameter is a token:
 - “WRITE2” or “CODEC” will write to the CODEC device at the currently selected slave address (I2C mode only).
 - “READ2” will read from the CODEC device at the values of a number of registers.

- “DELAY” or “WAIT” will implement a time delay specified up to 65535 milliseconds. The delay time is specified in decimal or hex if preceded by “0x”.
- ITERATE will cause the **whole** script to be repeated the specified number of times.

- The second parameter is the register address as a name or hex value.
- The third parameter is the data.
- Comments (i.e. lines beginning with „//“) are permitted in the file.
- Inline comments (i.e. //comment) are permitted.
- The data will be processed in the order written and written directly to the specified device. The screen controls will be updated once command in the file have finished.
- The use of the slave address in the file allows any device attached to the I2C bus to be controlled.
- For read operations, the result of the read is passed to the history log window.

Example files contents:

```
//Write to CODEC in 3 ways
CODEC MIC_L 0x01
WRITE2 MIC_R 0x02
0x34 0x09 0xB1

//Read CODEC starting at DAC_R
// for next 10 registers
//Result is visible in Datalog window

READ2 DAC_R 10

//Wait 255ms
DELAY 255
WAIT 0xFF
```

Alternative form

```
//Register Dump
//Slave  Register  Data
0x92    0x01    0x00
0x92    0x02    0x01
0x92    0x03    0x02
0x92    0x04    0x02
0x92    0x05    0x04
0x92    0x06    0x05
0x92    0x07    0x06
0x92    0x08    0x07
0x92    0x09    0x08
```

The results in the history log file are shown below.

The Read operations are in brackets following the command.

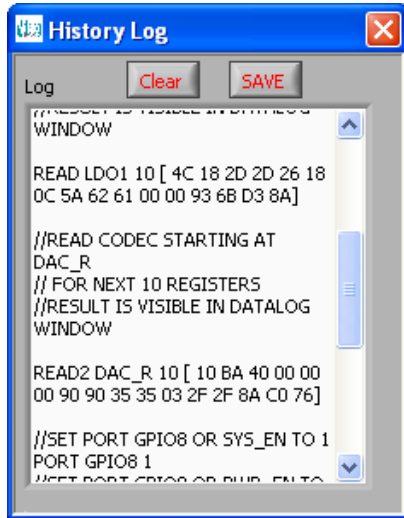

Appendix A – Socketed Miniboard (169-01-A)

A socketed miniboard is available for evaluation purposes. This PCB uses larger passive components (0402) to allow for customer experimentation. A soldered device can replace the socket on request.

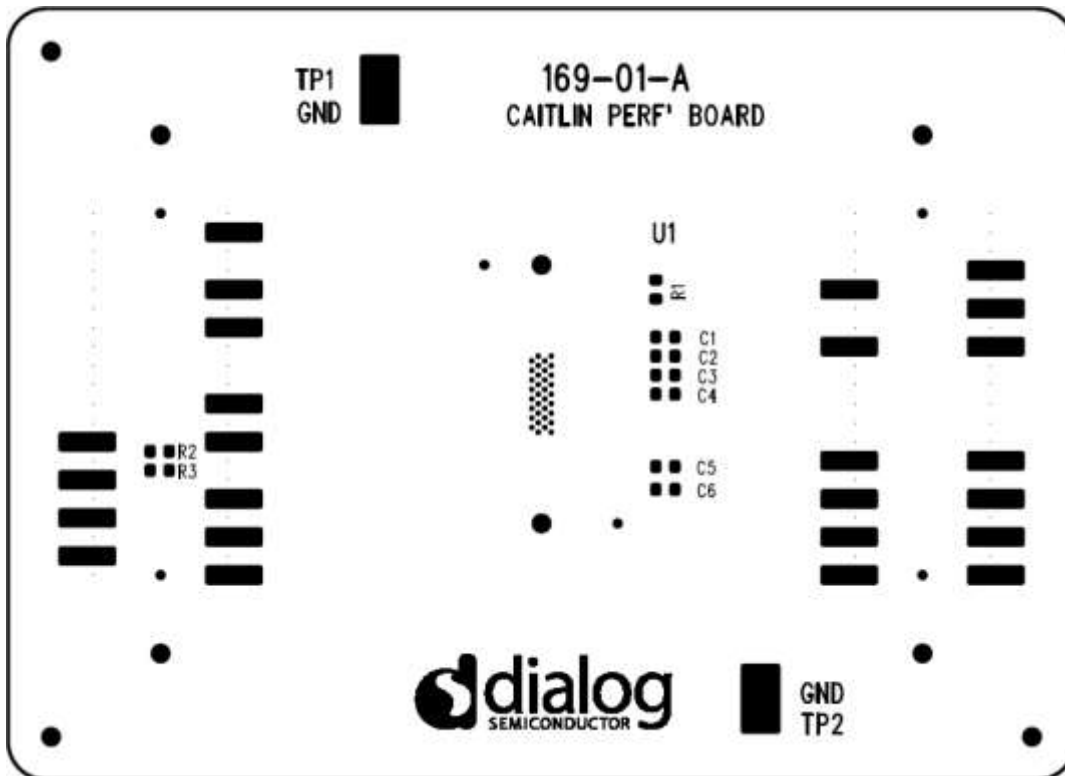

Figure 5 DA7212 Mini Board

REVISION HISTORY

REVISION	DATE	ORIGINATOR	CHANGE
1.0	28/06/2013	CM	Initial Release
1.1	20/11/2013	CM	Updated default jumper locations
1.2	21/11/2013	PH	Added description for each page in the GUI
1.3	12/01/2022	AM	Rebranded from Dialog to Renesas

REVISION HISTORY

REVISION	DATE	ORIGINATOR	CHANGE
1.0	28/06/2013	CM	Initial Release
1.1	20/11/2013	CM	Updated default jumper locations
1.2	21/11/2013	PH	Added description for each page in the GUI
1.3	12/01/2022	AM	Rebranded from Dialog to Renesas

IMPORTANT NOTICE AND DISCLAIMER

RENESAS ELECTRONICS CORPORATION AND ITS SUBSIDIARIES (“RENESAS”) PROVIDES TECHNICAL SPECIFICATIONS AND RELIABILITY DATA (INCLUDING DATASHEETS), DESIGN RESOURCES (INCLUDING REFERENCE DESIGNS), APPLICATION OR OTHER DESIGN ADVICE, WEB TOOLS, SAFETY INFORMATION, AND OTHER RESOURCES “AS IS” AND WITH ALL FAULTS, AND DISCLAIMS ALL WARRANTIES, EXPRESS OR IMPLIED, INCLUDING, WITHOUT LIMITATION, ANY IMPLIED WARRANTIES OF MERCHANTABILITY, FITNESS FOR A PARTICULAR PURPOSE, OR NON-INFRINGEMENT OF THIRD PARTY INTELLECTUAL PROPERTY RIGHTS.

These resources are intended for developers skilled in the art designing with Renesas products. You are solely responsible for (1) selecting the appropriate products for your application, (2) designing, validating, and testing your application, and (3) ensuring your application meets applicable standards, and any other safety, security, or other requirements. These resources are subject to change without notice. Renesas grants you permission to use these resources only for development of an application that uses Renesas products. Other reproduction or use of these resources is strictly prohibited. No license is granted to any other Renesas intellectual property or to any third party intellectual property. Renesas disclaims responsibility for, and you will fully indemnify Renesas and its representatives against, any claims, damages, costs, losses, or liabilities arising out of your use of these resources. Renesas' products are provided only subject to Renesas' Terms and Conditions of Sale or other applicable terms agreed to in writing. No use of any Renesas resources expands or otherwise alters any applicable warranties or warranty disclaimers for these products.

(Rev.1.0 Mar 2020)

Corporate Headquarters

TOYOSU FORESIA, 3-2-24 Toyosu,
Koto-ku, Tokyo 135-0061, Japan
www.renesas.com

Contact Information

For further information on a product, technology, the most up-to-date version of a document, or your nearest sales office, please visit:
www.renesas.com/contact/

Trademarks

Renesas and the Renesas logo are trademarks of Renesas Electronics Corporation. All trademarks and registered trademarks are the property of their respective owners.