

# RDER72A105K2K1H03B

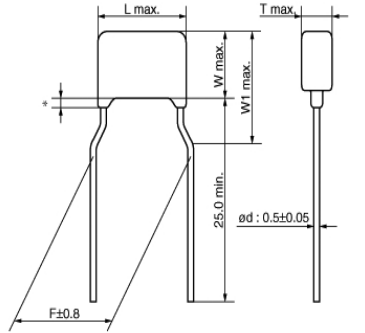

## Appearance & Shape

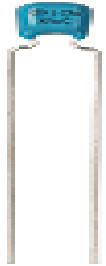

\* Coating extension does not exceed the end of the lead bend.  
 - Lead Wire : Solder Coated Copper Wire or Solder Coated CP Wire (in mm)

## References

Packaging	Specifications	Standard Packing Quantity
B	Bulk(Bag)	500

Mass (typ.)	
1 piece	0.17g

## Notices

Meet LF(Lead Free)[※LF : Lead content is less than 1000 ppm.], HF(Halogen Free)

### Attention

- 1.This datasheet is downloaded from the website of Murata Manufacturing Co., Ltd. Therefore, it's specifications are subject to change or our products in it may be discontinued without advance notice. Please check with our sales representatives or product engineers before ordering.
- 2.This datasheet has only typical specifications because there is no space for detailed specifications. Therefore, please review our product specifications or consult the approval sheet for product specifications before ordering.

# RDER72A105K2K1H03B



## Specifications

L size or Outer diameter D	5.5mm max.
Width	4.0mm max.
T size	3.15mm max.
Lead spacing F	5.0±0.8mm
Lead diameter d	0.5±0.05mm
Capacitance	1.0μF ±10%
Rated voltage	100Vdc
Temperature characteristics	X7R(EIA)
Capacitance change rate	±15%
Temperature range of temperature characteristics	-55°C to 125°C
Operating Temperature Range	-55°C to 125°C
W1 size	6.0mm

### Attention

1.This datasheet is downloaded from the website of Murata Manufacturing Co., Ltd. Therefore, it's specifications are subject to change or our products in it may be discontinued without advance notice. Please check with our sales representatives or product engineers before ordering.

2.This datasheet has only typical specifications because there is no space for detailed specifications.

Therefore, please review our product specifications or consult the approval sheet for product specifications before ordering.

# RDER72A105K2K1H03B



## Characteristic Data

The charts below may show another part number which shares its characteristics.

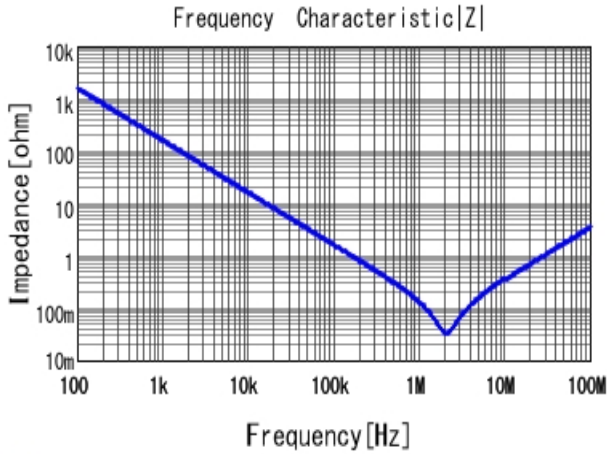

■ RDER72A105K2K1H03B |Z| DC0V, 25degC

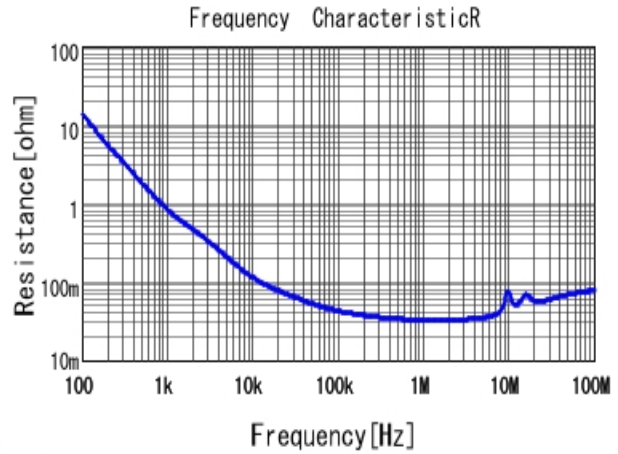

■ RDER72A105K2K1H03B R DC0V, 25degC

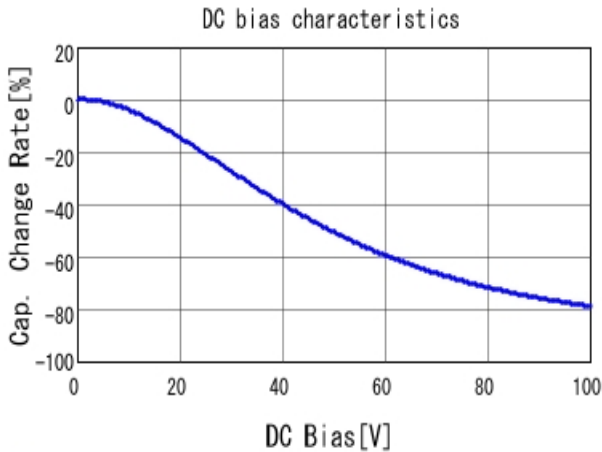

■ RDER72A105K2K1H03B C-DC bias capchange, 25.0degC, AC1

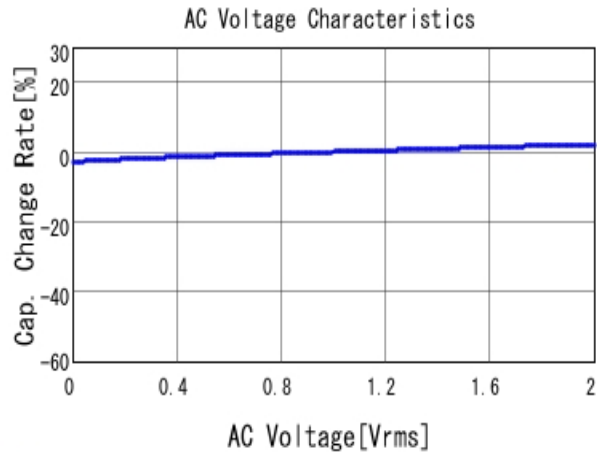

■ RDER72A105K2K1H03B C-AC Voltage capchange, DC0V, 25.0

**Attention**

- 1.This datasheet is downloaded from the website of Murata Manufacturing Co., Ltd. Therefore, it's specifications are subject to change or our products in it may be discontinued without advance notice. Please check with our sales representatives or product engineers before ordering.
- 2.This datasheet has only typical specifications because there is no space for detailed specifications. Therefore, please review our product specifications or consult the approval sheet for product specifications before ordering.

# RDER72A105K2K1H03B

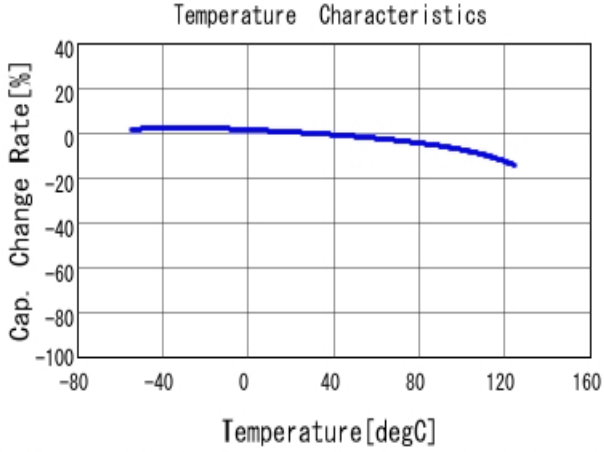

■ RDER72A105K2K1H03B C-Temp. capchange, DC0.0V, AC1.0Vr

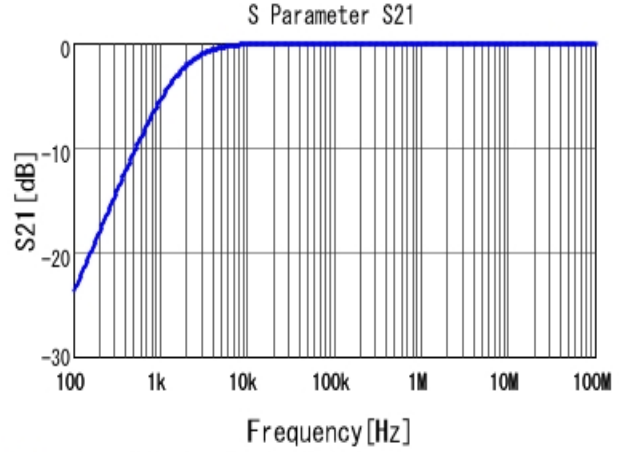

■ RDER72A105K2K1H03B S21 DC0V, 25degC

**Attention**

- 1.This datasheet is downloaded from the website of Murata Manufacturing Co., Ltd. Therefore, it's specifications are subject to change or our products in it may be discontinued without advance notice. Please check with our sales representatives or product engineers before ordering.
- 2.This datasheet has only typical specifications because there is no space for detailed specifications. Therefore, please review our product specifications or consult the approval sheet for product specifications before ordering.