



# Disc Varistor

## FEATURES

- \* Wide operating voltages ranging from 5Vrms to 1000Vrms (6Vdc to 1465Vdc).
- \* Fast response time of less than 25nS, instantly clamping the transient over voltage.
- \* High surge current handling capability.
- \* High energy absorption capability.
- \* Low clamping voltages, providing better surge protection
- \* Low capacitance values, providing digital switching circuitry protection.
- \* High insulation resistance, preventing electric arching to the adjacent devices or circuits.

## APPLICATIONS

- \* Transistor, Diode, IC, Thyristor or Triac semiconductor protection.
- \* Surge protection in consumer electronics.
- \* Surge protection in industrial electronics.
- \* Surge protection in electronic home appliances, gas and petroleum appliances.
- \* Relay and electromagnetic valve surge absorption.

## General Characteristics Definition

- \*Operating Temperature: -40 °C ~ +85 °C
- \*Storage Temperature: -40 °C ~ +125 °C
- \*Working Surface Temperature: +115 °C
- \*Insulation Resistance: > 100M Ω
- \*Coating (Epoxy Resin): Flame-Retardant to UL 94 V-0

## Material

- \*Coating: Epoxy Resin
- \*Lead Wire: Tin Cu. Wire
- \*Electrode: Silver  
Solder
- \*Disk: Zinc Oxide

## Ordering Information

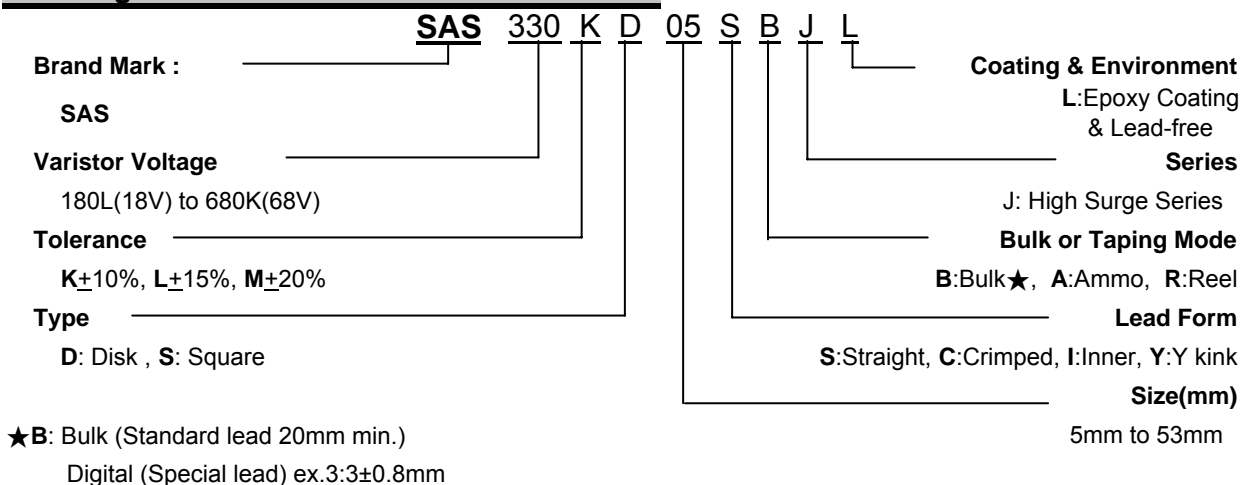



# Disc Varistor

## Terminology Definitions

Technical Term	Descriptions																									
Varistor Voltage (Vb)	Voltage across the varistor measured at a specified current (1mA or 0.1mA)																									
Maximum Clamping Voltage	Peak voltage across the varistor with a specified peak impulse current (8x20 msec). Waveform see fig. 1																									
Maximum Allowable/ Rated Voltage	Maximum sine wave voltage (rms) or the maximum dc voltage which may be applied continuously																									
Non-linear Exponent ( $\alpha$ )	A measure of varistor voltage-current nonlinearity between two given operating currents, I1 and I2, as described by $I=KV^\alpha$ , where K is a device constant, and $\alpha = \log(I1/I2) / \log(V1/V2)$																									
Leakage Current	Maximum current with rated voltage (80% varistor voltage ) applied. 200 $\mu$ A maximum.																									
Single Pulse Transient Energy	Energy which may be dissipated for a single 10/1000 $\mu$ S pulse of a maximum rated current, with AC/DC voltage applied, without causing device failure. <b>Energy=K*Vc*Ip*T</b> Where Ip(Ipeak) is the peak current applied, Vc(Vclamp) is the clamp voltage which results, T is the impulse duration and K is a constant (1.4 for 10/1000 $\mu$ S waveform). Waveform see fig. 1																									
Withstanding Surge Current	The maximum peak current that can be applied to the varistor for a single 8/20 $\mu$ S current waveform, with line voltage applied, without causing device failure. Waveform see fig. 1																									
Energy	The maximum energy within the varistor voltage change of $\pm 10\%$ when one impulse is applied. <b>Energy=K*Vc*Ip*T</b> Where Ip(Ipeak) is the peak current Applied, Vc(Vclamp) is the clamp voltage which results, T is the impulse duration and K is a constant.																									
Rated Wattage	The maximum average power that can be dissipated at the specified ambient temperature resulting from a group of pulses occurring within a specified isolated time period, without causing device failure.																									
Varistor Voltage Temperature Coefficient	$\frac{V_b \text{ at } 25^\circ\text{C} - V_b \text{ at } 85^\circ\text{C}}{V_b \text{ at } 25^\circ\text{C}} * \frac{1}{60} * 100\% \quad (+0.05\%/^\circ\text{C max.})$																									
Surge Life Time Rating	<p>The change of Vb that measured after 10,000 times pulses applied continuously with the interval of ten seconds at room temperature. Waveform see fig. 1</p> <table border="1"> <tbody> <tr> <td rowspan="2">5D Series</td> <td>180LD05 to 680KD05</td> <td>8A (8/20<math>\mu</math>S)</td> </tr> <tr> <td>820KD05 to 751KD05</td> <td>40A (8/20<math>\mu</math>S)</td> </tr> <tr> <td rowspan="2">7D Series</td> <td>180LD07 to 680KD07</td> <td>30A (8/20<math>\mu</math>S)</td> </tr> <tr> <td>820KD07 to 821KD07</td> <td>90A (8/20<math>\mu</math>S)</td> </tr> <tr> <td rowspan="2">10D Series</td> <td>180LD10 to 680KD10</td> <td>50A (8/20<math>\mu</math>S)</td> </tr> <tr> <td>820KD10 to 112KD10</td> <td>150A (8/20<math>\mu</math>S)</td> </tr> <tr> <td rowspan="2">14D Series</td> <td>180LD14 to 680KD14</td> <td>80A (8/20<math>\mu</math>S)</td> </tr> <tr> <td>820KD14 to 182KD14</td> <td>200A (8/20<math>\mu</math>S)</td> </tr> <tr> <td rowspan="2">20D Series</td> <td>180LD20 to 680KD20</td> <td>150A (8/20<math>\mu</math>S)</td> </tr> <tr> <td>820KD20 to 182KD20</td> <td>250A (8/20<math>\mu</math>S)</td> </tr> </tbody> </table>	5D Series	180LD05 to 680KD05	8A (8/20 $\mu$ S)	820KD05 to 751KD05	40A (8/20 $\mu$ S)	7D Series	180LD07 to 680KD07	30A (8/20 $\mu$ S)	820KD07 to 821KD07	90A (8/20 $\mu$ S)	10D Series	180LD10 to 680KD10	50A (8/20 $\mu$ S)	820KD10 to 112KD10	150A (8/20 $\mu$ S)	14D Series	180LD14 to 680KD14	80A (8/20 $\mu$ S)	820KD14 to 182KD14	200A (8/20 $\mu$ S)	20D Series	180LD20 to 680KD20	150A (8/20 $\mu$ S)	820KD20 to 182KD20	250A (8/20 $\mu$ S)
5D Series	180LD05 to 680KD05		8A (8/20 $\mu$ S)																							
	820KD05 to 751KD05	40A (8/20 $\mu$ S)																								
7D Series	180LD07 to 680KD07	30A (8/20 $\mu$ S)																								
	820KD07 to 821KD07	90A (8/20 $\mu$ S)																								
10D Series	180LD10 to 680KD10	50A (8/20 $\mu$ S)																								
	820KD10 to 112KD10	150A (8/20 $\mu$ S)																								
14D Series	180LD14 to 680KD14	80A (8/20 $\mu$ S)																								
	820KD14 to 182KD14	200A (8/20 $\mu$ S)																								
20D Series	180LD20 to 680KD20	150A (8/20 $\mu$ S)																								
	820KD20 to 182KD20	250A (8/20 $\mu$ S)																								

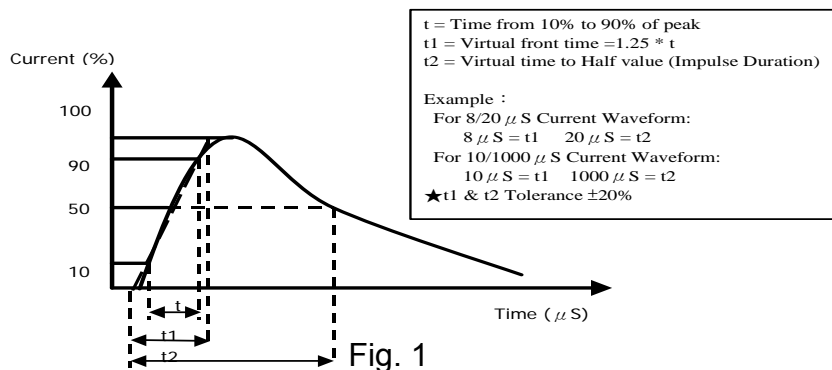

# Disc Varistor



嵩隆電子股份有限公司  
Song Long Electronics CO., LTD  
東莞嵩隆電子有限公司  
Song Long Electronics (Dong Guan) CO., LTD

## Reliability Test

### Mechanical Ratings

Test Parameter	Test Condition / Description		Performance Requirements	
Terminal Pull Strength	After gradually applying the load specified below and keeping the unit fixed for ten seconds, the terminal shall be visually examined for any damage.	Diameter	Loading	No visible damage
		0.6mm	1.0 Kg	
		0.8mm	1.0 Kg	
		1.0mm	2.0 Kg	
Terminal Bending Strength	The unit shall be secured with its terminal kept vertical and the weight specified below be applied in the axial direction. The terminal shall gradually be bent by 90° in one direction, then 90° in the opposite direction, and again back to the original position. The damage of the terminal shall be visually examined.	Diameter	Loading	No visible damage
		0.6mm	0.5 Kg	
		0.8mm	0.5 Kg	
		1.0mm	1.0 Kg	
Vibration	The Specimen shall be vibrated by its lead wires with a total amplitude of 1.5 mm and a varying frequency of 10~55~10HZ(each minutes) for a period of 2 hours respectively in each X,Y and Z directions.		No visible damage $\Delta VB/VB\% \leq \pm 5\%$	
Soldering-solderability	After dipping the terminal to depth of approximately 3 mm from the specimen in a soldering bath of 260°C for 10±1(D5: 5±1) seconds. Thereafter the terminal shall be visually examined.		Terminations shall be uniformly tinned	
Soldering-Resistance to Solder Heat	After preheating the specimen, the specimen shall be completely immersed into a soldering bath having a temperature of 260±5°C for 10±1 (D5: 5±1) seconds or iron of 400±5°C for 3±0.5 seconds. There after the change of Vb and mechanical damage shall be examined.		No visible damage $\Delta VB/VB\% \leq \pm 5\%$	

### ENVIRONMENTAL RATINGS

Dry Heat Loading	The specimen shall be applied continuously the maximum allowable voltage at the specified conditions for specified period and then stored at room temperature and normal humidity over 2 hours. Thereafter, the change of Vb and mechanical damage shall be examined. Ambient temp : 125±2°C ; Period : 1000±24hours.			$\Delta VB/VB\% \leq \pm 10\%$	
High Temperature Storage	In a drying oven without load. Ambient temp : 125±2°C ; period : 1000±24hours			$\Delta VB/VB\% \leq \pm 5\%$	
Damp Heat Loading	The specimen shall be applied continuously the maximum allowable voltage at the specified conditions for specified period and then stored at room temperature and normal humidity over 2 hours. Thereafter, the change of Vb and mechanical damage shall be examined. Ambient condition : 40±2°C , 90 to 95%R.H. ; period : 1000±24 hours			$\Delta VB/VB\% \leq \pm 10\%$	
Temperature Cycle	Condition the specimen to each temperature form step 1 to step 4 in this order for the period shown in the table of specifications. The change of Vb and mechanical damage shall be examined after 2 hours.	Step	Temp°C	Period	No visible damage $\Delta VB/VB\% \leq \pm 10\%$
		1	-40±3°C	30 min.	
		2	Room Temp	15 min.	
		3	85±2°C	30 min.	
4	Room Temp	15 min.			
Surge Lifetime Rating	The change of Vb shall be measured after the impulse listed below is applied 10,000 times continuously with the interval of ten seconds at room temperature.			No visible damage $\Delta VB/VB\% \leq \pm 10\%$	
Voltage Proof	Voltage : 2500VAC Leakage Current $\leq 0.5mA$ Time : 60 Seconds			No Breakdown	



# Disc Varistor

## Electrical Characteristic

Part No.	Max. Allowable Voltage (V)		Varistor Voltage (V)		Max. Surge Current (A)		Max. Energy (J)	Max. Clamping Voltage (V)		Rated Wattage
	V <sub>RMS</sub>	V <sub>DC</sub>	V	Tolerance	1 Time	2 Times	10/1000 $\mu$ S	I <sub>p</sub>	V <sub>c</sub>	W
680KD05SBJL	40	56	68	$\pm 10\%$	250	125	2.2	1	135	0.01
560KD05SBJL	35	45	56	$\pm 10\%$	250	125	1.8	1	110	0.01
470KD05SBJL	30	38	47	$\pm 10\%$	250	125	1.5	1	93	0.01
390KD05SBJL	25	31	39	$\pm 10\%$	250	125	1.2	1	77	0.01
330KD05SBJL	20	26	33	$\pm 10\%$	250	125	1.1	1	65	0.01
270KD05SBJL	17	22	27	$\pm 10\%$	250	125	0.9	1	53	0.01
220KD05SBJL	14	18	22	$\pm 10\%$	250	125	0.7	1	43	0.01
180LD05SBJL	10	14	18	$\pm 15\%$	250	125	0.6	1	38	0.01

## Marking



Trademark : SAS  
Part No. : 180L05J to 680KD05J  
Date Code:

Y : Year

Y	2004	2005	2006	2007	2008
Code	4	5	6	7	8
Y	2009	2010	2011	2012	2013
Code	9	0	1	2	3

M : Month

M	Jan	Feb	Mar	Apr	May	Jun
Code	1	2	3	4	5	6
M	Jul	Aug	Sep	Oct	Nov	Dec
Code	7	8	9	O	N	D



# Disc Varistor

## Dimension - SB / CB / IB / YB Lead forming Series

SB Series

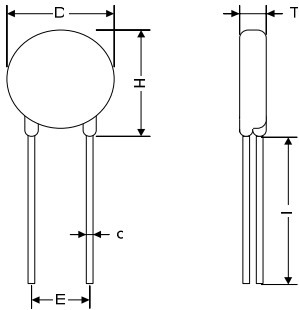

CB Series

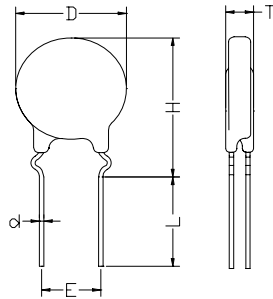

IB Series

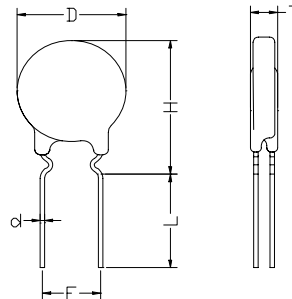

YB Series

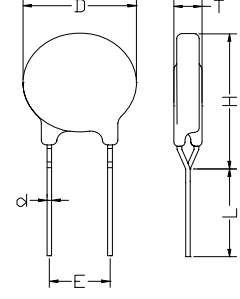

Unit : mm

Part No.	D Max.	H Max.		L min.	E ± 0.8	d ± 0.05	T Max.
		SB	CB / IB / YB				
680KD05SBJL	7.0	10.0	13.0	20.0	5.0	0.6	4.5
560KD05SBJL	7.0	10.0	13.0	20.0	5.0	0.6	4.5
470KD05SBJL	7.0	10.0	13.0	20.0	5.0	0.6	4.5
390KD05SBJL	7.0	10.0	13.0	20.0	5.0	0.6	4.5
330KD05SBJL	7.0	10.0	13.0	20.0	5.0	0.6	4.5
270KD05SBJL	7.0	10.0	13.0	20.0	5.0	0.6	4.5
220KD05SBJL	7.0	10.0	13.0	20.0	5.0	0.6	4.5
180LD05SBJL	7.0	10.0	13.0	20.0	5.0	0.6	4.5

## Packing Specifications

### Bulk Packing Dimension

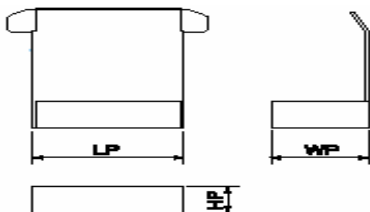

Symbol	Dimension
LP :	250 mm
WP :	165 mm
HP :	60 mm
Bag. :	210 mm * 225 mm
Carton :	350 mm * 250 mm * 200 mm

## Quantity per Packing Method

Unit : Pcs

Dimension	Part No.	Bag	Box	Carton
D05	180L to 680K	1,000	2,000	12,000



# Disc Varistor

## Dimension - SA / SR / CA / CR Ammo & Reel Series

SA / SR

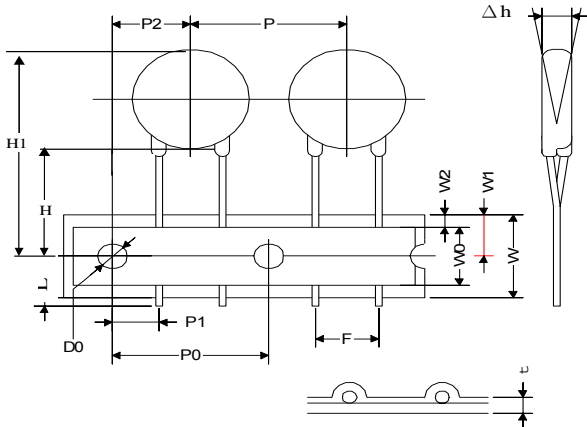

CA / CR Series

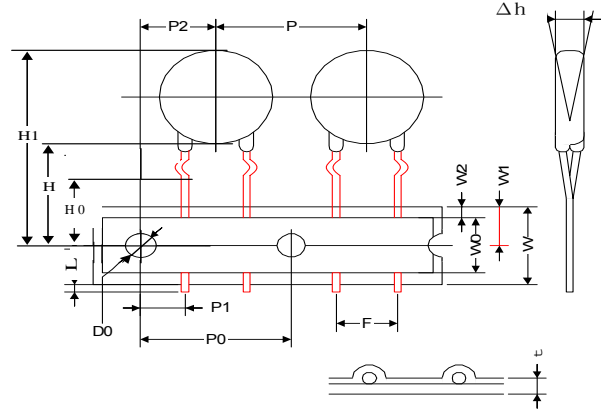

Unit: mm

Symbol	P	P0	P1	P2	F	W	W0	W1
D05	12.7±1.0	12.7±0.3	3.85±0.7	6.35±1.3	5.0±0.5	18.0±1.0	12.5max.	9.0±0.5
Symbol	W2	H	H0	H1	Δh	L	D0	t
D05	3.0max.	20.0±2.0	16.0±1.0	29.0max.	0±2	1.0max.	4.0±0.2	0.6±0.3

## Packing Specifications

### Ammo & Reel Packing Dimension

#### Ammo & Reel Box

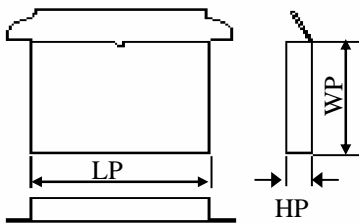

Symbol	Ammo
LP :	330 mm
WP :	310 mm
HP :	50 mm
Carton :	350 mm * 270 mm * 330 mm

Symbol	Reel
LP :	365mm
WP :	365mm
HP :	57mm

#### Reel

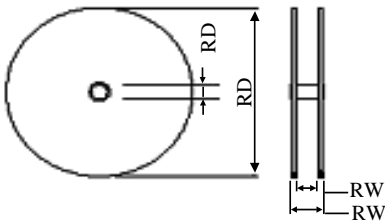

RD :	360 mm
RD1 :	30 ± 0.5 mm
RW :	45mm
RW1 :	50mm
Carton :	380 mm * 380 mm * 480 mm

## Quantity per Packing Method

Unit : Pcs

Dimension	Part No.	Box		Carton	
		Ammo	Reel	Ammo	Reel
D05	180L to 680K	2,000	2,000	10,000	16,000