

**SINGLE-PHASE GLASS PASSIVATED
SILICON BRIDGE RECTIFIER**

VOLTAGE 50 to 1000 Volts CURRENT 2.0 Amperes

FEATURES

- * Reverse voltage to 600v
- * Surge overload ratings to 50 amperes peak
- * Good for printed circuit board assembly
- * Mounting position: Any
- * Weight: 1.88 grams
- * Silver-plated copper leads

MECHANICAL DATA

- * UL listed the recognized component directory, file #E94233
- * Epoxy: Device has UL flammability classification 94V-O



RC-2

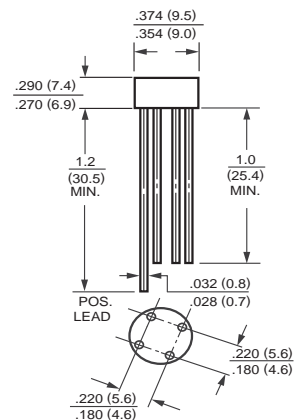

Dimensions in inches and (millimeters)

MAXIMUM RATINGS AND ELECTRICAL CHARACTERISTICS

Ratings at 25°C ambient temperature unless otherwise specified.
Single phase, half wave, 60 Hz, resistive or inductive load.
For capacitive load, derate current by 20%.

MAXIMUM RATINGS (At TA = 25°C unless otherwise noted)

RATINGS	SYMBOL	RC201	RC202	RC203	RC204	RC205	RC206	RC207	UNITS
Maximum Recurrent Peak Reverse Voltage	VRRM	50	100	200	400	600	800	1000	Volts
Maximum RMS Bridge Input Voltage	VRMS	35	70	140	280	420	560	700	Volts
Maximum DC Blocking Voltage	VDC	50	100	200	400	600	800	1000	Volts
Maximum Average Forward Output Current at TA = 25°C	Io	2.0							Amps
Peak Forward Surge Current 8.3 ms single half sine-wave superimposed on rated load (JEDEC method)	IFSM	50							Amps
Typical Current Squared Time	I ² t	10.3							A ² /Sec
Operating Temperature Range	TJ	-55 to + 150							°C
Storage Temperature Range	TSTG	-55 to + 150							°C

ELECTRICAL CHARACTERISTICS (At TA = 25°C unless otherwise noted)

CHARACTERISTICS	SYMBOL	RC201	RC202	RC203	RC204	RC205	RC206	RC207	UNITS
Maximum Forward Voltage Drop per Bridge Element at 2.0A DC	VF	1.05							Volts
Maximum Reverse Current at Rated DC Blocking Voltage per element	IR	0.2							uAmps
		25							uAmps

NOTES : 1. Thermal Resistance : Heat-sink case mounted or if PCB mounted.
2. "Fully ROHS compliant", "100% Sn plating (Pb-free)".
3. Equivalent to Vishay's GBU6 Series.

RATING AND CHARACTERISTIC CURVES(RC201 THRU RC207)

FIG. 1 - MAXIMUM FORWARD SURGE CURRENT

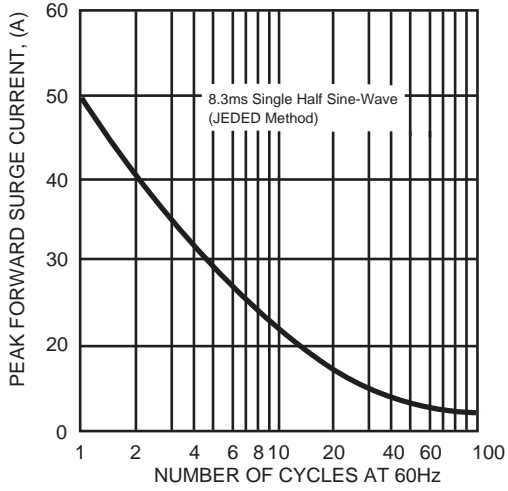

FIG. 2 - TYPICAL FORWARD CURRENT DERATING CURVE

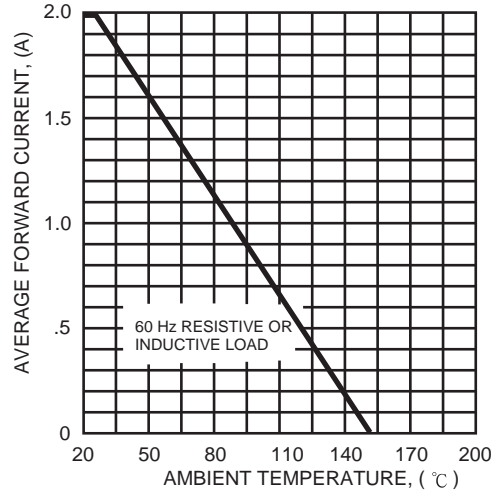

FIG. 3 - MAXIMUM REVERSE CHARACTERISTICS

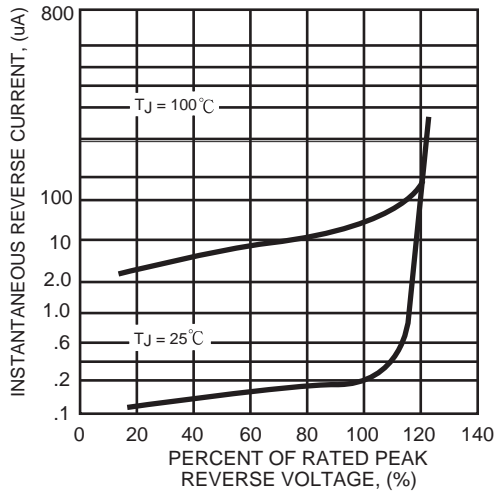
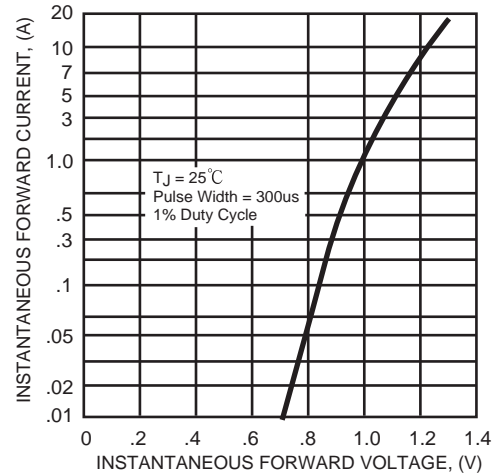

FIG. 4 - MAXIMUM INSTANTANEOUS FORWARD CHARACTERISTICS



PACKAGING OF DIODE AND BRIDGE RECTIFIERS

BULK PACK

PACKAGE	PACKING CODE	EA PER BOX	INNER BOX SIZE (mm)	CARTON SIZE (mm)	EA PER CARTON	GROSS WEIGHT(Kg)
RC-2	-B	600	165*252*59	347*320*271	6,000	10.30

eg(TYPE):RC207-B



RECTRON

Attachment information about RC20X

1. Internal Circuit

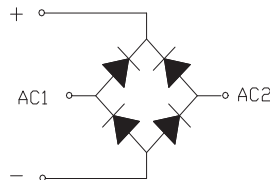

2. Marking on the body

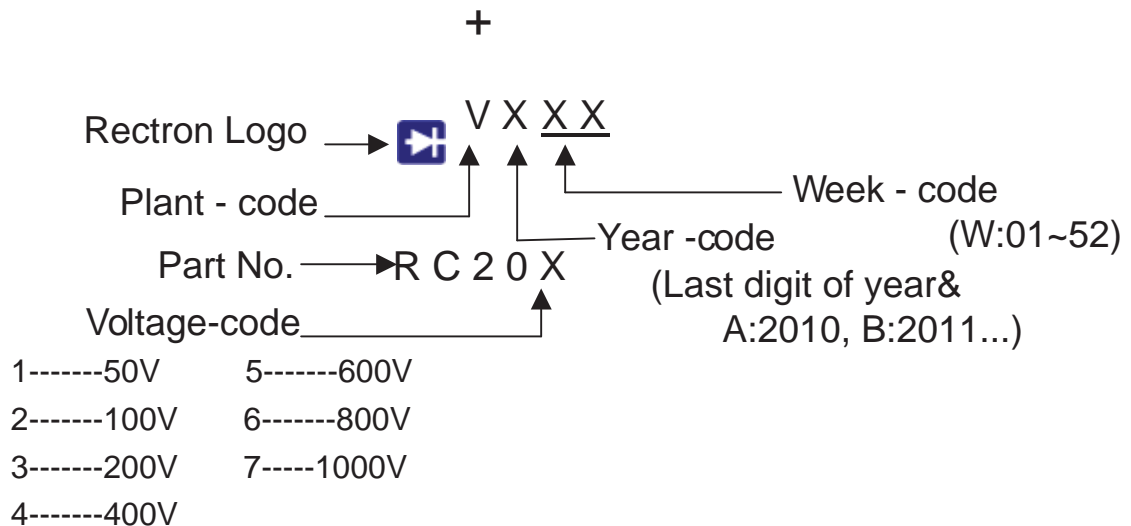

3. Items marked on the innerbox and carton

3.1 On the box (for-B)

CUSTOMER
TYPE
LOT NO.
QUANTITY
Q.A.
DATE

3.2 On the carton

CUSTOMER
TYPE
QUANTITY
LOT NO.
REMARK

DISCLAIMER NOTICE

Rectron Inc reserves the right to make changes without notice to any product specification herein, to make corrections, modifications, enhancements or other changes. Rectron Inc or anyone on its behalf assumes no responsibility or liability for any errors or inaccuracies. Data sheet specifications and its information contained are intended to provide a product description only. "Typical" parameters which may be included on RECTRON data sheets and/ or specifications can and do vary in different applications and actual performance may vary over time. Rectron Inc does not assume any liability arising out of the application or use of any product or circuit.

Rectron products are not designed, intended or authorized for use in medical, life-saving implant or other applications intended for life-sustaining or other related applications where a failure or malfunction of component or circuitry may directly or indirectly cause injury or threaten a life without expressed written approval of Rectron Inc. Customers using or selling Rectron components for use in such applications do so at their own risk and shall agree to fully indemnify Rectron Inc and its subsidiaries harmless against all claims, damages and expenditures.