

# SMD Power Inductor CDRH4D18C



## Description

- Ferrite drum core construction.
- Magnetically shielded.
- L × W × H: 5.1 × 5.1 × 2.0 mm Max.
- Product weight: 135mg(Ref.)
- Moisture Sensitivity Level: 1
- RoHS compliance.

## Environmental Data

- Operating temperature range: -40°C ~ +105°C (including coil's self temperature rise)
- Storage temperature range: -40°C ~ +105°C
- Solder reflow temperature: 260 °C peak.

## Packaging

- Carrier tape and reel packaging
- 7.0" diameter reel
- 1000pcs per reel

## Applications

- Ideally used in Mobile phone, PDA, MP3, HDD, DSC/DVC, Note book PC, etc as DC-DC converter inductors.

## Dimension - [mm]

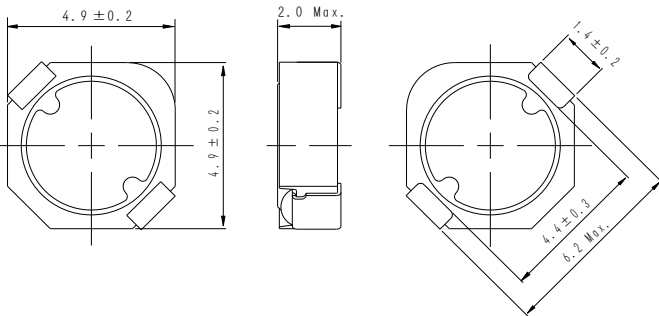

## Land pattern and Schematics - [mm]

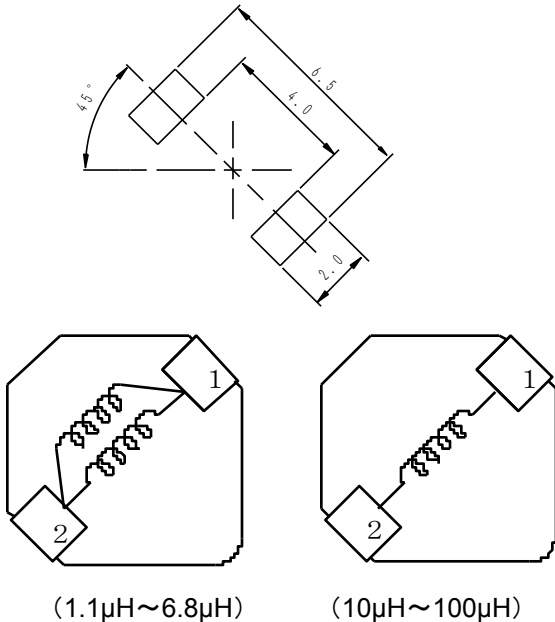



### Electrical Characteristics

Part No.	Stamp	Inductance ( $\mu\text{H}$ ) [within] ※1	D.C.R.( $\Omega$ ) Max. (Typ.) (at 20°C)	Rated Current (A) ※2
CDRH4D18CNP-1R1PC	A	1.1 $\pm$ 25%	29m(23m)	2.4
CDRH4D18CNP-2R2PC	B	2.2 $\pm$ 25%	39m(31m)	1.7
CDRH4D18CNP-3R0PC	C	3.0 $\pm$ 25%	61m(49m)	1.5
CDRH4D18CNP-4R7PC	D	4.7 $\pm$ 25%	110m(88m)	1.15
CDRH4D18CNP-6R8PC	E	6.8 $\pm$ 25%	125m(100m)	1.05
CDRH4D18CNP-100PC	F	10 $\pm$ 25%	156m(125m)	830m
CDRH4D18CNP-150PC	G	15 $\pm$ 25%	194m(155m)	700m
CDRH4D18CNP-220PC	H	22 $\pm$ 25%	323m(258m)	600m
CDRH4D18CNP-330PC	I	33 $\pm$ 25%	550m(440m)	460m
CDRH4D18CNP-470PC	J	47 $\pm$ 25%	783m(626m)	410m
CDRH4D18CNP-680PC	K	68 $\pm$ 25%	1.16(925m)	305m
CDRH4D18CNP-101PC	L	100 $\pm$ 25%	1.51(1.21)	250m

※1. Inductance measuring condition: at 100kHz.

※2. Rated current: The DC current at which the inductance decreases to 65% of its nominal value or when  $\Delta t=40^\circ\text{C}$ , whichever is lower ( $T_a=20^\circ\text{C}$ ).

# SMD Power Inductor CDRH4D18C

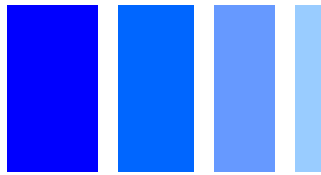

## Saturation Current & Temperature Rise Graph

— L (20°C) — L (100°C) —  $\Delta T$

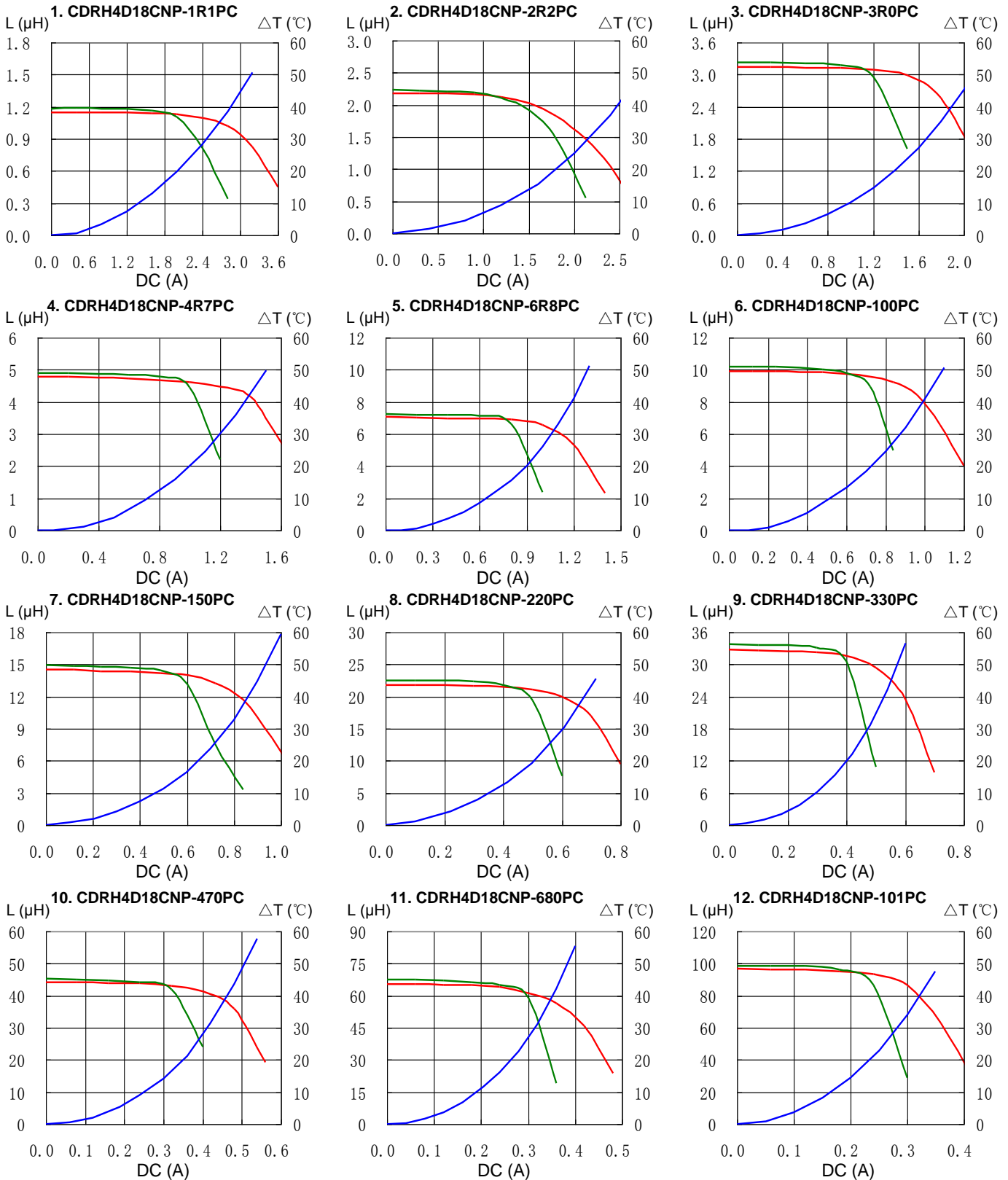

# SMD Power Inductor CDRH4D18C

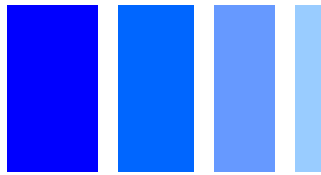

## Solder Reflow Condition

Heat Endurance

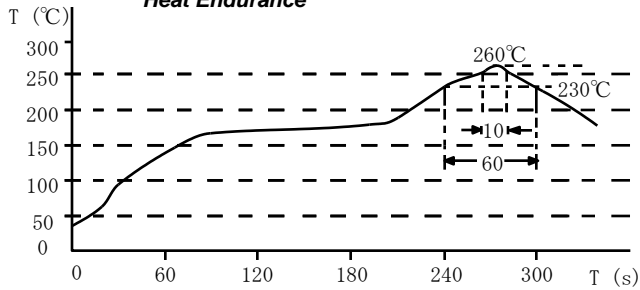

Temperature Chart

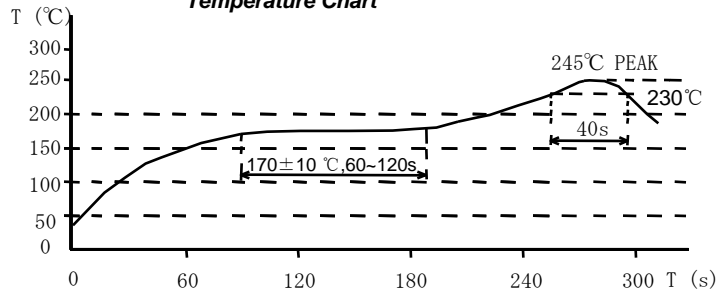

Please refer to the sales offices on our website - <http://www.sumida.com>

### Hong Kong

Tel.+852-2880-6781  
FAX.+852-2565-9600  
[sales@hk.sumida.com](mailto:sales@hk.sumida.com)

### Saitama(Japan)

Tel.+81-48-691-7300  
FAX.+81-48-691-7340  
[sales@jp.sumida.com](mailto:sales@jp.sumida.com)

### Chicago

Tel.+1-847-545-6700  
FAX. +1-847-545-6720  
[sales@us.sumida.com](mailto:sales@us.sumida.com)

### Shanghai

Tel.+86-21-5836-3299  
FAX.+86-21-5836-3266  
[shanghai.sales@cn.sumida.com](mailto:shanghai.sales@cn.sumida.com)

### Seoul

Tel.+82-2-6237-0777  
FAX.+82-2-6237-0778  
[sales@kr.sumida.com](mailto:sales@kr.sumida.com)

### Obernzell

Tel.+49-8591-937-0  
FAX. +49-8591-937-103  
[contact@eu.sumida.com](mailto:contact@eu.sumida.com)

### Shenzhen

Tel.+86-755-8291-0228  
FAX.+86-755-8291-0338  
[shenzhen.sales@cn.sumida.com](mailto:shenzhen.sales@cn.sumida.com)

### Singapore

Tel.+65-6296-3388  
FAX.+65-6841-4426  
[sales@sg.sumida.com](mailto:sales@sg.sumida.com)

### Neumarkt

Tel.+49-9181-4509-110  
FAX. +49-9181-4509-310  
[infocomp@eu.sumida.com](mailto:infocomp@eu.sumida.com)

### Taipei

Tel.+886-2-8751-2737  
FAX.+886-2-8751-2738  
[sales@tw.sumida.com](mailto:sales@tw.sumida.com)

### San Jose

Tel.+1-408-321-9660  
FAX.+1-408-321-9308  
[sales@us.sumida.com](mailto:sales@us.sumida.com)

# Mouser Electronics

Authorized Distributor

Click to View Pricing, Inventory, Delivery & Lifecycle Information:

## Sumida:

[CDRH4D18CNP-100PC](#) [CDRH4D18CNP-220NC](#) [CDRH4D18CNP-101NC](#) [CDRH4D18CNP-1R1NC](#)  
[CDRH4D18CNP-100NC](#) [CDRH4D18CNP-680NC](#) [CDRH4D18CNP-6R8NC](#) [CDRH4D18CNP-4R7NC](#)  
[CDRH4D18CNP-150NC](#) [CDRH4D18CNP-330NC](#) [CDRH4D18CNP-2R2NC](#) [CDRH4D18CNP-470NC](#) [CDRH4D18CNP-](#)  
[3R0NC](#) [CDRH4D18CNP-3R0PC](#) [CDRH4D18CNP-101PC](#) [CDRH4D18CNP-470PC](#) [CDRH4D18CNP-1R1PC](#)  
[CDRH4D18CNP-220PC](#) [CDRH4D18CNP-2R2PC](#)