

Long-life grade capacitors

Applications

- Frequency converters
- Professional switch-mode power supplies in industrial electronics and in data processing equipment
- Switch-mode power supplies in entertainment electronics

Features

- High reliability
- Outstanding ripple current capability
- Low equivalent series resistance *ESR*
- Different case sizes available for each capacitance value

Construction

- Charge-discharge proof, polar
- Aluminum case, fully insulated
- Snap-in solder pins to hold component in place on PC-board
- Minus pole marking on case surface
- Minus pole not insulated from case
- Overload protection (safety vent)

Terminals

- Standard version with 2 terminals
2 lengths available: 6,3 and 4,5 mm
- 3 terminals: length 4,5 mm
(terminal arrangement ensures correct insertion)



KAL0274-A

Specifications and characteristics in brief

	B41505	B43505
Rated voltage U_R	10 ... 100 VDC	200 ... 450 VDC
Surge voltage U_S	$1,15 \cdot U_R$	$1,15 \cdot U_R$ (for $U_R \leq 250$ VDC) $1,10 \cdot U_R$ (for $U_R \geq 400$ VDC)
Rated capacitance C_R	560 ... 33 000 μ F	100 ... 1 500 μ F
Capacitance tolerance	$\pm 20 \% \triangleq M$	$\pm 20 \% \triangleq M$
Dissipation factor $\tan \delta$ (20°C, 120 Hz)	max. $\tan \delta = 0,80$; $U_R = 10$ VDC max. $\tan \delta = 0,60$; $U_R = 16$ VDC max. $\tan \delta = 0,45$; $U_R = 25$ VDC max. $\tan \delta = 0,40$; $U_R = 35$ VDC max. $\tan \delta = 0,30$; $U_R = 50$ VDC max. $\tan \delta = 0,20$; $U_R = 63 \dots 100$ VDC	$\tan \delta \leq 0,15$ for $U_R \leq 400$ VDC $\tan \delta \leq 0,20$ for $U_R = 450$ VDC
Leakage current I_L (5 min, 20°C)	$I_L \leq 0,3 \mu A \cdot \left(\frac{C_R}{\mu F} \cdot \frac{U_R}{V} \right)^{0,7} + 4 \mu A$	

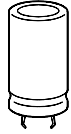
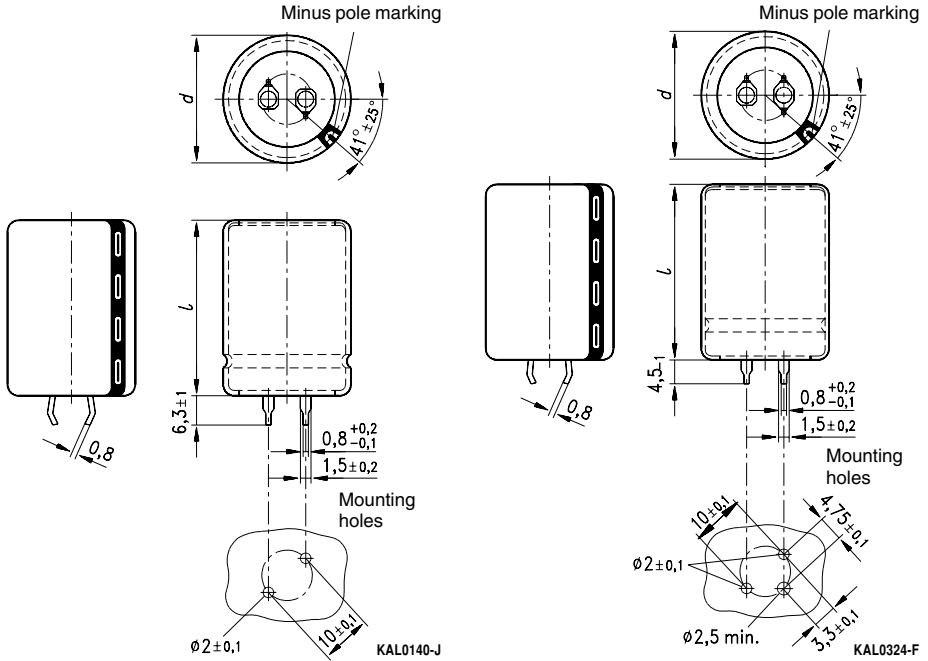

	B41505	B43505
Self-inductance <i>ESL</i>	Approx. 20 nH	
Useful life		
105 °C; U_R ; I_{-R}	> 5 000 h	> 5 000 h
85 °C; U_R ; I_{-max}	> 12 000 h	> 11 000 h
40 °C; U_R ; $2,1 \cdot I_{-R}$	> 250 000 h	> 200 000 h
Requirements:	$\Delta C/C \leq \pm 45\%$ of initial value $\tan \delta \leq 3$ times initial spec. limit $I_L \leq$ initial specified limit Failure percentage: $\leq 1\%$ Failure rate: ≤ 50 fit ($\leq 50 \cdot 10^{-9}/h$) (for definition "fit", refer to chapter "Quality", page 62)	$\Delta C/C \leq \pm 30\%$ of initial value $\tan \delta \leq 3$ times initial spec. limit $I_L \leq$ initial specified limit
Load life test		
105 °C; U_R ; I_{-R}	5 000 h	4 000 h
Post test requirements:	$\Delta C/C \leq \pm 20\%$ of initial value $\tan \delta \leq 2$ times initial spec. limit $I_L \leq$ initial specified limit	$\Delta C/C \leq \pm 20\%$ of initial value $\tan \delta \leq 2$ times initial spec. limit $I_L \leq$ initial specified limit
Voltage endurance test		
85 °C; U_R	2 000 h	2 000 h
Post test requirements:	$\Delta C/C \leq \pm 15\%$ of initial value $\tan \delta \leq 1,3$ times spec. limit $I_L \leq$ initial specified limit	$\Delta C/C \leq \pm 10\%$ of initial value $\tan \delta \leq 1,3$ times spec. limit $I_L \leq$ initial specified limit
Vibration resistance	To IEC 68-2-6, test Fc: displacement amplitude 0,35 mm, frequency range 10 ... 55 Hz, acceleration max. 5 g, duration 3×2 h	
IEC climatic category	To IEC 60068-1: $U_R \leq 400$ VDC: 40/105/56 (– 40 °C/+ 105 °C/56 days damp heat test) $U_R = 450$ VDC: 25/105/56 (– 25 °C/+ 105 °C/56 days damp heat test)	
Detail specification	—	Similar to CECC 30301-809
Sectional specification	IEC 60384-4	IEC 60384-4

Dimensional drawings

Snap-in terminals, standard (length $6,3 \pm 1$ mm). Also available in a shorter version with a length of $4,5 - 1$ mm. For packing mode and ordering example see next page.

Snap-in capacitors are also available with 3 terminals (length $4,5 - 1$ mm). For packing mode and ordering example see next page.

Dimensions (mm)		Approx. weight (g)	Packing units (pieces)
$d + 1$	$l \pm 2$		
22	25	9	160
22	30	12	160
22	35	15	160
22	40	18	160
22	45	20	160
25	25	13	130
25	30	17	130
25	35	19	130
25	40	22	130
25	45	25	130

Dimensions (mm)		Approx. weight (g)	Packing units (pieces)
$d + 1$	$l \pm 2$		
30	25	20	80
30	30	23	80
30	35	29	80
30	40	36	80
30	45	41	80
30	50	46	80
35	25	25	60
35	30	31	60
35	35	37	60
35	40	44	60
35	45	52	60
35	50	59	60



Packing of snap-in capacitors



For ecological reasons the packing is pure cardboard. Components can be withdrawn (in full or in part) in the correct position for insertion.

Ordering codes

Snap-in terminals Version	Identification in 3rd block of ordering code
Standard terminals (6,3 ± 1) mm	M000
Short terminals (4,5 – 1) mm	M007
3 terminals (4,5 – 1) mm	M002

Ordering example:

B43505A9107M007 } snap-in capacitor with short terminals
B43505A9107M002 } snap-in capacitor with 3 terminals

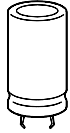
Overview of available types
Type B 41 505

U_R (VDC)	10	16	25	35	50	63	80	100
C_R (μ F)	Case dimensions $d \times l$ (mm)							
560								25 × 25
680								22 × 35
1 000						22 × 25	25 × 25	25 × 35 30 × 30
1 200							30 × 25	
1 500						22 × 35	25 × 35	30 × 40
2 200				22 × 25	22 × 35	25 × 35 30 × 30	30 × 35	30 × 50
3 300				22 × 30 25 × 25	25 × 35	30 × 40	35 × 35	35 × 50
4 700			22 × 30 25 × 25	22 × 40	30 × 35	35 × 35	35 × 45	
6 800	22 × 25	22 × 30	25 × 30	25 × 40	30 × 50	35 × 50		
10 000	22 × 30	25 × 30	25 × 40	30 × 40	35 × 45			
15 000	22 × 40	25 × 40	30 × 40	35 × 40				
18 000				35 × 45				
22 000	30 × 35	30 × 40						
33 000	30 × 45							

The capacitance and voltage ratings listed above are available in different cases upon request. Other voltage and capacitance ratings are also available upon request.

Overview of available types
Type B 43 505

U_R (VDC)	200	250	400	450
C_R (μ F)	Case dimensions $d \times l$ (mm)			
100			25 × 30	22 × 45 30 × 30
150			25 × 40 30 × 30	25 × 45 30 × 35
220	22 × 30	25 × 30	30 × 40 35 × 30	30 × 45 35 × 35
330	22 × 40	25 × 40 30 × 30	30 × 50 35 × 40	35 × 50
390			35 × 45	35 × 50
470	25 × 40 30 × 30	30 × 35	35 × 50	
680	30 × 40	30 × 45		
1 000	35 × 45	35 × 45		
1 500	35 × 50			

The capacitance and voltage ratings listed above are available in different cases upon request. Other voltage and capacitance ratings are also available upon request.

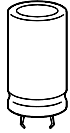
Technical data and ordering codes

U_R	C_R	Case dimensions	ESR_{typ}	Z_{max}	$I_{\sim max}$	$I_{\sim max}$	$I_{\sim R}^{(1)}$	Ordering code ²⁾
VDC	100 Hz 20 °C μF	$d \times l$ mm	100 Hz 20 °C m Ω	10 kHz 20 °C m Ω	100 Hz 40 °C A	100 Hz 85 °C A	100 Hz 105 °C A	
B41505								
10	6 800	22 × 25	98	78	4,2	2,8	1,4	B41505A3688M000
	10 000	22 × 30	70	56	5,4	3,6	1,8	B41505A3109M000
	15 000	22 × 40	49	39	6,9	4,6	2,3	B41505A3159M000
	22 000	30 × 35	35	28	9,0	6,0	3,0	B41505A3229M000
	33 000	30 × 45	25	20	12	7,8	3,9	B41505A3339M000
16	6 800	22 × 30	61	49	5,4	3,6	1,8	B41505A4688M000
	10 000	25 × 30	45	36	6,6	4,4	2,2	B41505A4109M000
	15 000	25 × 40	32	26	8,4	5,6	2,8	B41505A4159M000
	22 000	30 × 40	23	18	11	7,0	3,5	B41505A4229M000
25	4 700	22 × 30	71	57	4,8	3,2	1,6	B41505A5478M000
	4 700	25 × 25	71	57	4,8	3,2	1,6	B41505F5478M000
	6 800	25 × 30	54	43	5,7	3,8	1,9	B41505A5688M000
	10 000	25 × 40	40	32	7,5	5,0	2,5	B41505A5109M000
	15 000	30 × 40	29	23	9,6	6,4	3,2	B41505A5159M000
35	2 200	22 × 25	113	90	3,3	2,2	1,1	B41505A7228M000
	3 300	22 × 30	75	60	4,5	3,0	1,5	B41505A7338M000
	3 300	25 × 25	75	60	4,5	3,0	1,5	B41505F7338M000
	4 700	22 × 40	60	48	5,7	3,8	1,9	B41505A7478M000
	6 800	25 × 40	46	37	6,9	4,6	2,3	B41505A7688M000
	10 000	30 × 40	35	28	8,7	5,8	2,9	B41505A7109M000
	15 000	35 × 40	25	20	11	7,6	3,8	B41505A7159M000
	18 000	35 × 45	23	18	13	8,6	4,3	B41505A7189M000
50	2 200	22 × 35	113	90	4,2	2,8	1,4	B41505A6228M000
	3 300	25 × 35	75	60	5,4	3,6	1,8	B41505A6338M000
	4 700	30 × 35	56	45	6,6	4,4	2,2	B41505A6478M000
	6 800	30 × 50	44	35	8,7	5,8	2,9	B41505A6688M000
	10 000	35 × 45	33	26	11	7,2	3,6	B41505A6109M000

1) 120 Hz conversion factor of ripple current: $I_{\sim} (120 \text{ Hz}) = 1,03 \cdot I_{\sim} (100 \text{ Hz})$

2) Ordering code for standard terminals (6,3 mm).

To determine the ordering code for short terminals (4,5 mm) and 3 terminals (4,5 mm) see page 258.



U_R	C_R 100 Hz 20 °C	Case dimensions $d \times l$ mm	ESR_{typ} 100 Hz 20 °C mΩ	Z_{max} 10 kHz 20 °C mΩ	$I_{~max}$ 100 Hz 40 °C A	$I_{~max}$ 100 Hz 85 °C A	$I_{~R}^{(1)}$ 100 Hz 105 °C A	Ordering code ²⁾
VDC	μF							
63	1000	22 × 25	199	159	3,0	2,0	1,0	B41505A8108M000
	1500	22 × 35	133	106	4,2	2,8	1,4	B41505A8158M000
	2200	25 × 35	90	72	5,1	3,4	1,7	B41505A8228M000
	2200	30 × 30	106	85	5,4	3,6	1,8	B41505F8228M000
	3300	30 × 40	70	56	6,9	4,6	2,3	B41505A8338M000
	4700	35 × 35	56	45	8,1	5,4	2,7	B41505A8478M000
	6800	35 × 50	39	31	11	7,2	3,6	B41505A8688M000
80	1000	25 × 25	166	133	3,9	2,6	1,3	B41505A0108M000
	1200	30 × 25	138	110	4,5	3,0	1,5	B41505A0128M000
	1500	25 × 35	111	89	5,4	3,6	1,8	B41505A0158M000
	2200	30 × 35	75	60	6,0	4,0	2,0	B41505A0228M000
	3300	35 × 35	60	48	8,4	5,6	2,8	B41505A0338M000
	4700	35 × 45	42	34	10	6,8	3,4	B41505A0478M000
	100	560	25 × 25	237	190	3,0	2,0	1,0
680		22 × 35	195	156	3,6	2,4	1,2	B41505A9687M000
1000		25 × 35	133	106	4,2	2,8	1,4	B41505A9108M000
1000		30 × 30	133	106	4,5	3,0	1,5	B41505F9108M000
1500		30 × 40	88	70	5,7	3,8	1,9	B41505A9158M000
2200		30 × 50	75	60	6,9	4,6	2,3	B41505A9228M000
3300		35 × 50	50	40	9,0	6,0	3,0	B41505A9338M000

1) 120 Hz conversion factor of ripple current: $I_{~} (120 \text{ Hz}) = 1,03 \cdot I_{~} (100 \text{ Hz})$

2) Ordering code for standard terminals (6,3 mm).

To determine the ordering code for short terminals (4,5 mm) and 3 terminals (4,5 mm) see page 258.

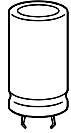
Technical data and ordering codes

U_R	C_R	Case dimensions	ESR_{typ}	Z_{max}	$I_{\sim max}$	$I_{\sim max}$	$I_{\sim R}^{(1)}$	Ordering code ²⁾
VDC	100 Hz 20 °C μF	$d \times l$ mm	100 Hz 20 °C m Ω	10 kHz 20 °C m Ω	100 Hz 40 °C A	100 Hz 85 °C A	100 Hz 105 °C A	
B43305								
200	220	22 × 30	580	700	2,9	1,9	0,96	B43505E2227M000
	330	22 × 40	390	470	4,0	2,6	1,3	B43505E2337M000
	470	25 × 40	280	330	5,1	3,4	1,7	B43505E2477M000
	470	30 × 30	280	330	5,1	3,3	1,7	B43505G2477M000
	680	30 × 40	190	230	6,7	4,4	2,2	B43505E2687M000
	1 000	35 × 45	130	160	9,4	6,2	3,1	B43505E2108M000
	1 500	35 × 50	90	110	12	7,8	3,9	B43505E2158M000
250	220	25 × 30	580	700	3,2	2,1	1,0	B43505A2227M000
	330	25 × 40	390	470	4,3	2,8	1,4	B43505A2337M000
	330	30 × 30	390	470	4,2	2,8	1,4	B43505C2337M000
	470	30 × 35	280	330	5,3	3,5	1,8	B43505A2477M000
	680	30 × 45	190	230	7,0	4,6	2,3	B43505A2687M000
	1 000	35 × 45	130	160	9,4	6,2	3,1	B43505A2108M000
	400	100	25 × 30	880	1090	2,1	1,4	0,70
150		25 × 40	590	730	2,9	1,9	0,95	B43505A9157M000
150		30 × 30	590	730	2,9	1,9	0,94	B43505C9157M000
220		30 × 40	400	500	3,8	2,5	1,3	B43505A9227M000
220		35 × 30	400	500	3,8	2,5	1,3	B43505C9227M000
330		30 × 50	270	330	5,1	3,3	1,7	B43505A9337M000
330		35 × 40	270	330	5,2	3,4	1,7	B43505C9337M000
390		35 × 45	230	280	5,9	3,8	1,9	B43505A9397M000
470		35 × 50	190	240	6,7	4,4	2,2	B43505A9477M000
450		100	22 × 45	1360	1600	2,3	1,5	0,75
	100	30 × 30	1360	1600	2,3	1,5	0,76	B43505C5107M000
	150	25 × 45	910	1070	3,0	2,0	1,0	B43505A5157M000
	150	30 × 35	910	1070	3,0	2,0	0,99	B43505C5157M000
	220	30 × 45	620	730	4,0	2,6	1,3	B43505A5227M000
	220	35 × 35	620	730	4,0	2,7	1,3	B43505C5227M000
	330	35 × 50	410	490	5,6	3,7	1,8	B43505A5337M000
	390	35 × 50	350	410	6,1	4,0	2,0	B43505A5397M000

Preferred types

 1) 120 Hz conversion factor of ripple current: $I_{\sim} (120 \text{ Hz}) = 1,03 \cdot I_{\sim} (100 \text{ Hz})$

2) Ordering code for standard terminals (6,3 mm).

To determine the ordering code for short terminals (4,5 mm) and 3 terminals (4,5 mm) see page 258.

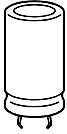

B41505 / B43505

Excellent Performance – 105 °C

Useful life

depending on ambient temperature T_A under ripple current operating conditions¹⁾

$U_R \leq 100$ VDC

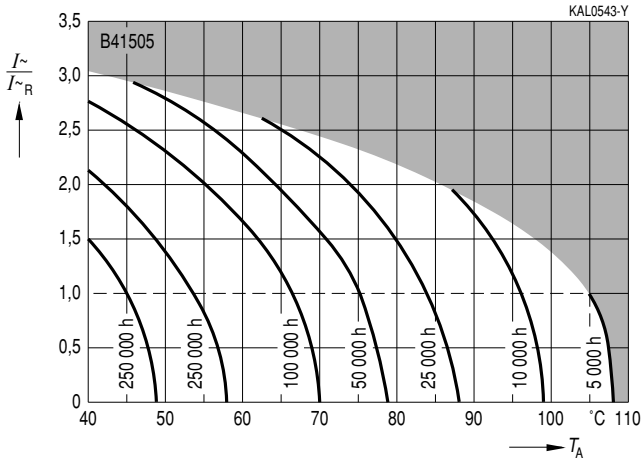

$U_R \geq 200$ VDC

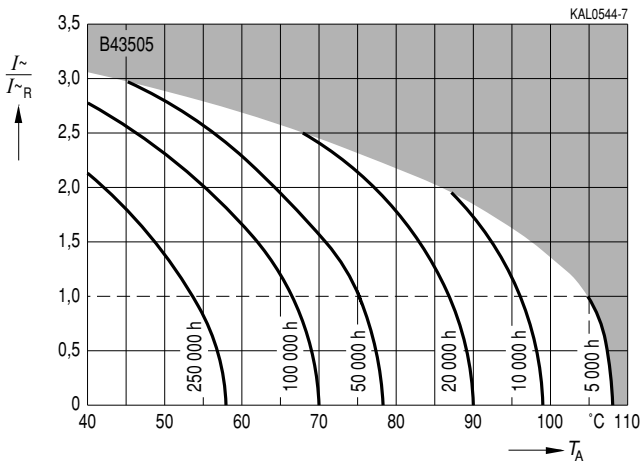

1) Refer to page 40 for an explanation on how to interpret the useful life graphs.

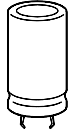

Frequency factor of permissible ripple current I_{\sim} versus frequency f
 $U_R \leq 100$ VDC

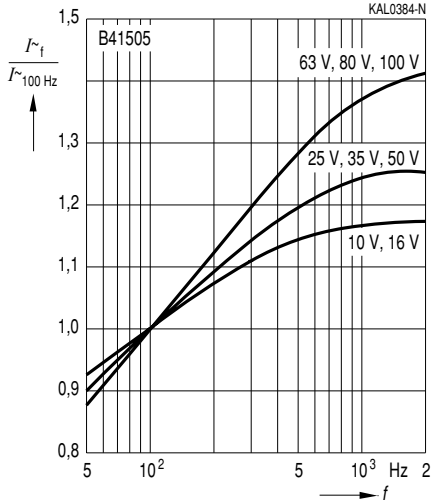

Frequency factor of permissible ripple current I_{\sim} versus frequency f
 $U_R \geq 200$ VDC

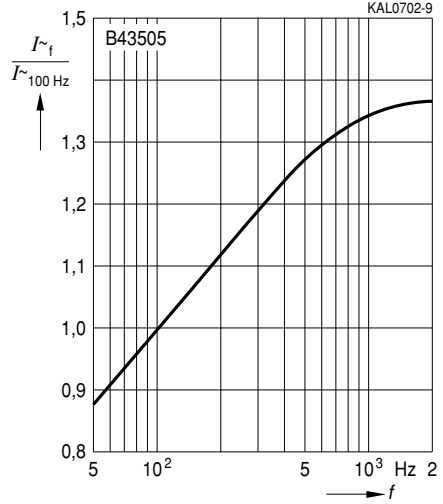

Frequency characteristics of ESR
 Typical behavior
 $U_R \leq 100$ VDC

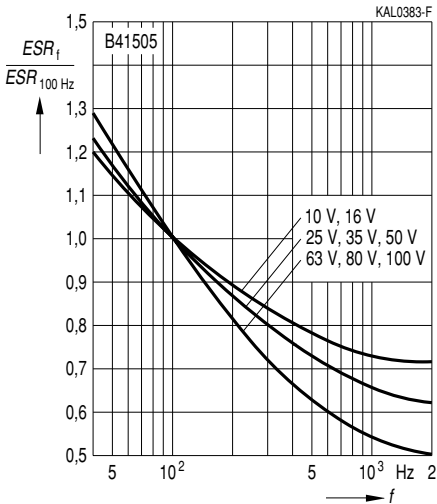

Frequency characteristics of ESR
 Typical behavior
 $U_R \geq 200$ VDC

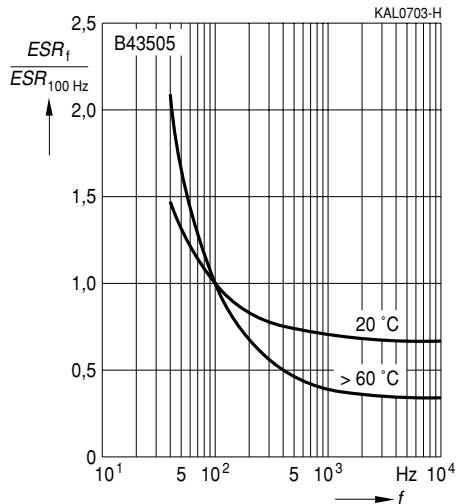

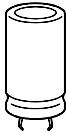

Impedance Z

versus frequency f

Typical behavior at 20 °C

$U_R \leq 100$ VDC

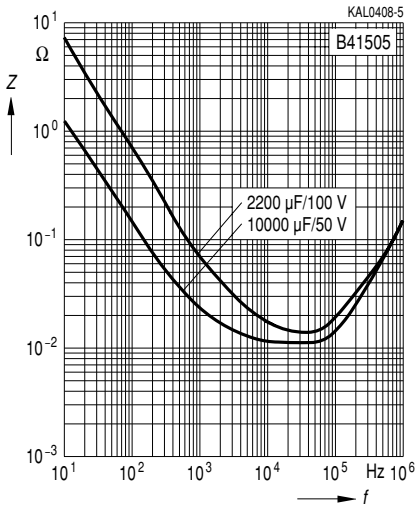

Impedance Z

versus frequency f

Typical behavior at 20 °C

$U_R \geq 200$ VDC

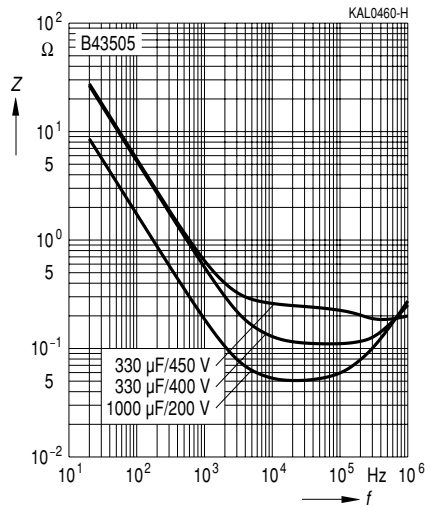

Herausgegeben von EPCOS AG

Unternehmenskommunikation, Postfach 80 17 09, 81617 München, DEUTSCHLAND

☎ ++49 89 636 09, FAX (0 89) 636-2 26 89

© EPCOS AG 2002. Vervielfältigung, Veröffentlichung, Verbreitung und Verwertung dieser Broschüre und ihres Inhalts ohne ausdrückliche Genehmigung der EPCOS AG nicht gestattet.

Bestellungen unterliegen den vom ZVEI empfohlenen Allgemeinen Lieferbedingungen für Erzeugnisse und Leistungen der Elektroindustrie, soweit nichts anderes vereinbart wird.

Diese Broschüre ersetzt die vorige Ausgabe.

Fragen über Technik, Preise und Liefermöglichkeiten richten Sie bitte an den Ihnen nächstgelegenen Vertrieb der EPCOS AG oder an unsere Vertriebsgesellschaften im Ausland. Bauelemente können aufgrund technischer Erfordernisse Gefahrstoffe enthalten. Auskünfte darüber bitten wir unter Angabe des betreffenden Typs ebenfalls über die zuständige Vertriebsgesellschaft einzuholen.

Published by EPCOS AG

Corporate Communications, P.O. Box 80 17 09, 81617 Munich, GERMANY

☎ ++49 89 636 09, FAX (0 89) 636-2 26 89

© EPCOS AG 2002. Reproduction, publication and dissemination of this brochure and the information contained therein without EPCOS' prior express consent is prohibited.

Purchase orders are subject to the General Conditions for the Supply of Products and Services of the Electrical and Electronics Industry recommended by the ZVEI (German Electrical and Electronic Manufacturers' Association), unless otherwise agreed.

This brochure replaces the previous edition.

For questions on technology, prices and delivery please contact the Sales Offices of EPCOS AG or the international Representatives.

Due to technical requirements components may contain dangerous substances. For information on the type in question please also contact one of our Sales Offices.