

BSS123T-HF

**N-Channel
RoHS Device
Halogen Free**

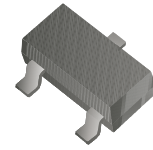

V(BR)DSS	RDS(on)Typ	ID
100V	2.8Ω @ 10V	100mA
	3.0Ω @ 4.5V	100mA

Features

- ESD protected gate
- High speed switching
- Pb-free lead plating and halogen-free package
- Easily designed drive circuits
- Low-voltage drive
- Easy to use in parallel

Circuit diagram

- G : Gate
- S : Source
- D : Drain

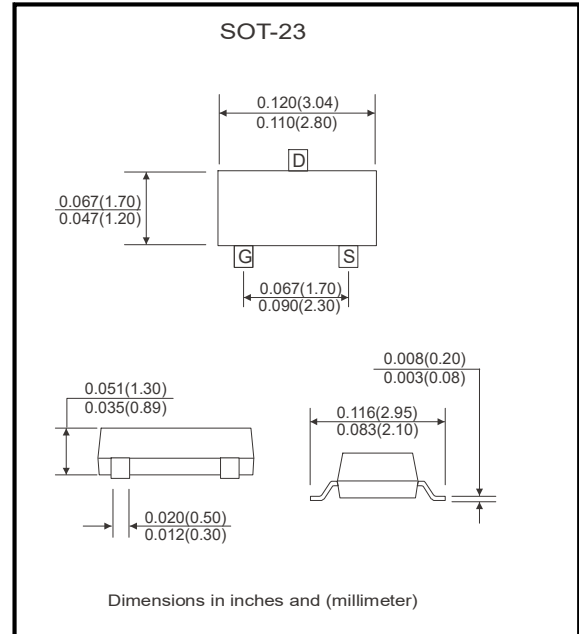
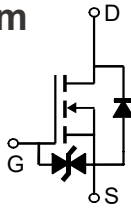

Maximum Ratings (at Ta=25 °C unless otherwise noted)

Parameter	Symbol	Limits	Unit
Drain-Source Voltage	V _{DSS}	100	V
Gate-Source Voltage	V _{GSS}	±20	
Continuous Drain Current @V _{GS} =10V, T _A =25°C	I _D	190	mA
Continuous Drain Current @V _{GS} =10V, T _A =70°C		152	
Pulsed Drain Current	I _{DM}	760 *1	
Total Power Dissipation	P _D	300 *2	mW
Operating Junction Temperature Range	T _j	-55~+150	°C
Storage Temperature Range	T _{stg}	-55~+150	

Thermal Characteristics

Parameter	Symbol	Value	Unit
Thermal Resistance, Junction to Ambient	R _{θJA}	416 *2	°C/W

Note : *1. Pulse Width ≤ 300μs, Duty cycle ≤2%

*2. When the device is mounted on a glass epoxy board with area measuring 1×0.75×0.62 inch

Electrical Characteristics (at T_A=25°C unless otherwise noted)

Symbol	Min.	Typ.	Max.	Unit	Test Conditions
Static					
BV _{DSS} *	100	-	-	V	V _{GS} =0V, I _D =250μA
V _{GS(th)}	1.0	-	2.5		V _{DS} =V _{GS} , I _D =250μA
I _{GSS}	-	-	±10	μA	V _{GS} =±16V, V _{DS} =0V
I _{DSS}	-	-	1		V _{DS} =80V, V _{GS} =0V
	-	-	5		V _{DS} =80V, V _{GS} =0V, T _j =55°C
R _{DS(ON)} *	-	2.8	5.6	Ω	I _D =100mA, V _{GS} =10V
	-	3.0	7.0		I _D =100mA, V _{GS} =4.5V
G _{FS}	100	-	-	mS	V _{DS} =10V, I _D =100mA
Dynamic					
C _{iss}	-	26	39	pF	V _{DS} =25V, V _{GS} =0V, f=1MHz
C _{oss}	-	11	16		
C _{rss}	-	3.1	4.6		
*t _{d(on)}	-	4.2	6.3	ns	V _{DS} =50V, I _D =0.26A, V _{GS} =10V, R _G =6Ω
*t _r	-	15.2	22.8		
*t _{d(off)}	-	10.2	15.3		
*t _f	-	18.8	28.2		
*Q _g	-	1.85	2.8	nC	V _{DS} =80V, I _D =0.26A, V _{GS} =10V
*Q _{gs}	-	0.72	1.1		
*Q _{gd}	-	0.17	0.26		
Body Diode					
*V _{SD}	-	0.9	1.3	V	I _S =0.34A

*Pulse Test : Pulse Width ≤300μs, Duty Cycle≤2%

Typical Characteristics

Typical Output Characteristics

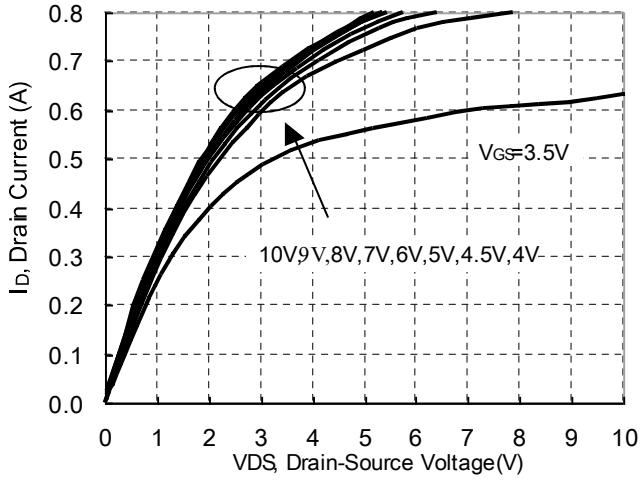

Breakdown Voltage vs Junction Temperature

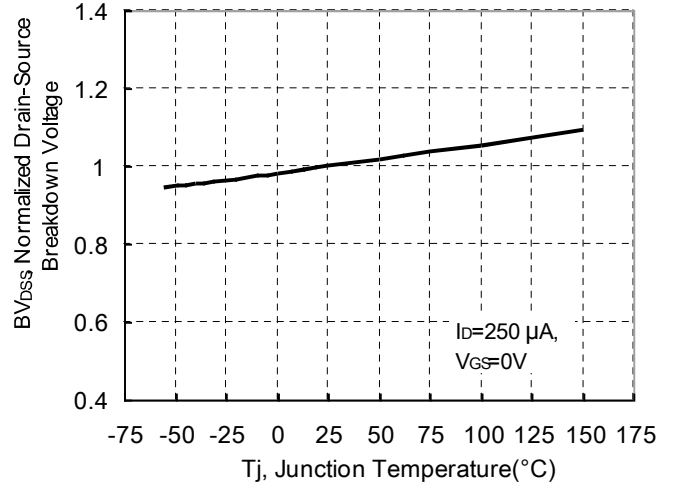

Static Drain-Source On-State resistance vs Drain Current

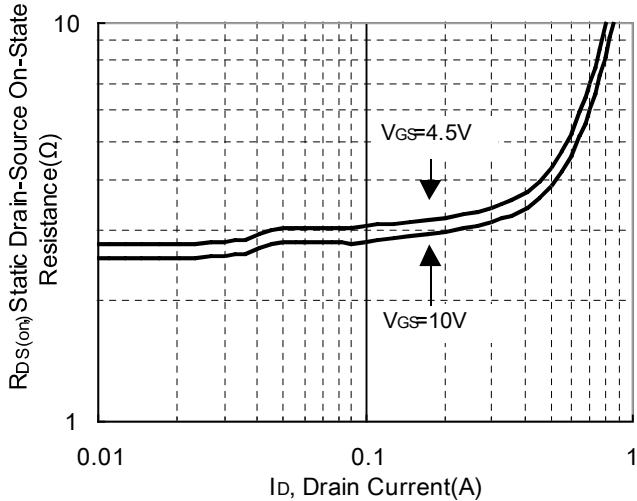

Reverse Drain Current vs Source-Drain Voltage

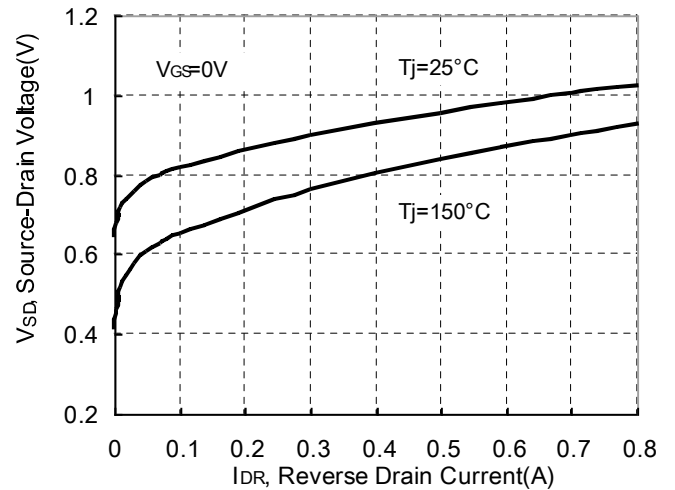

Static Drain-Source On-State Resistance vs Gate-Source Voltage

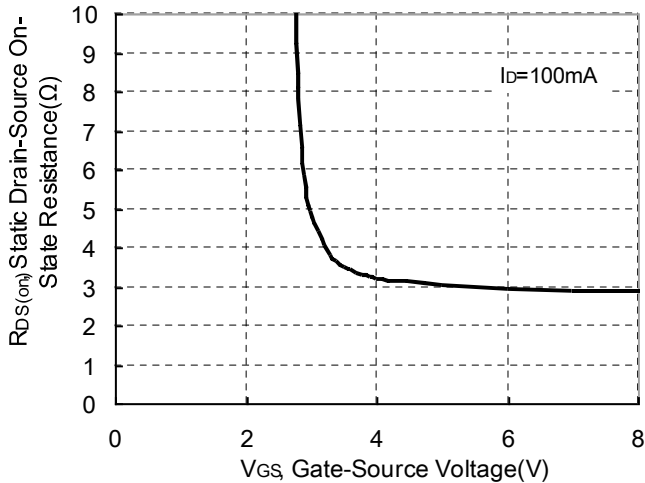

Drain-Source On-State Resistance vs Junction Temperature

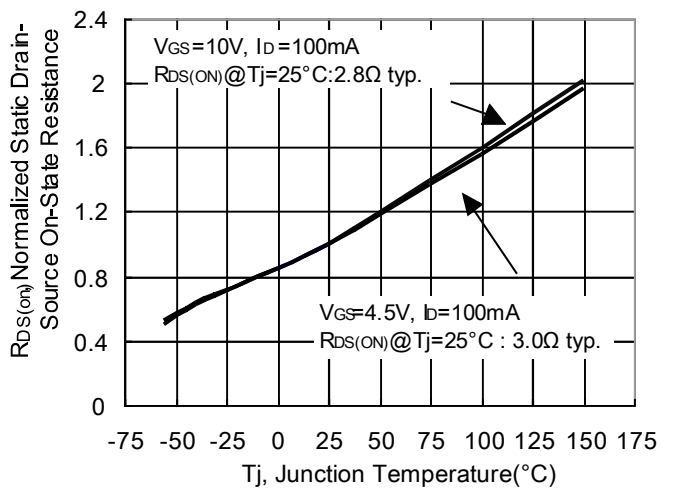

Typical Characteristics(Cont.)

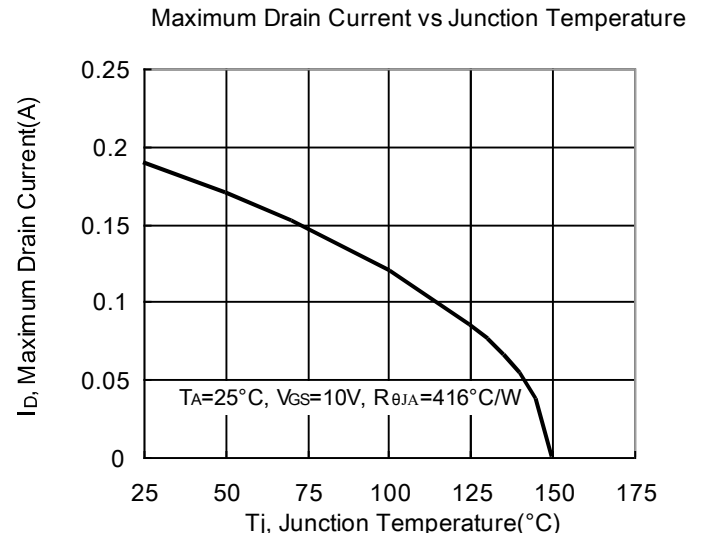
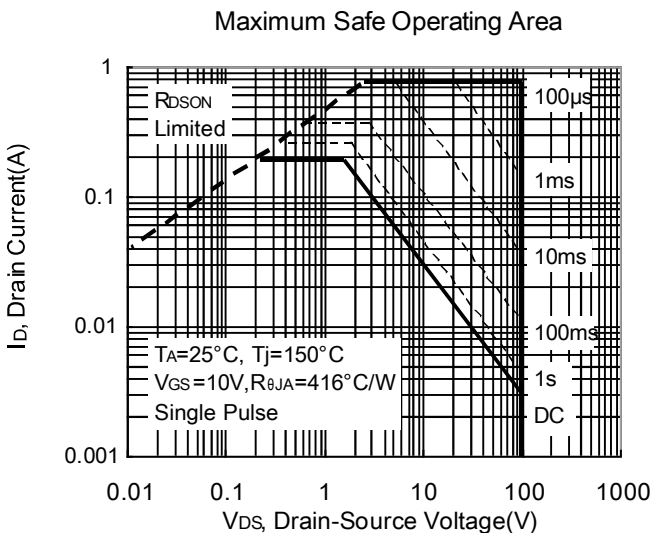
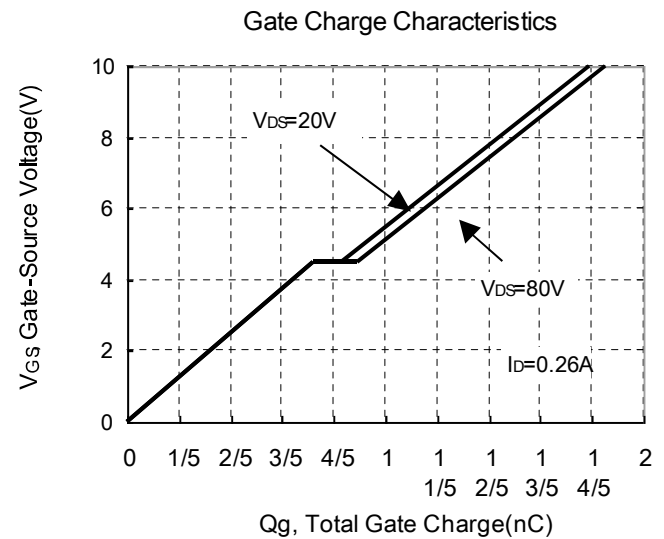
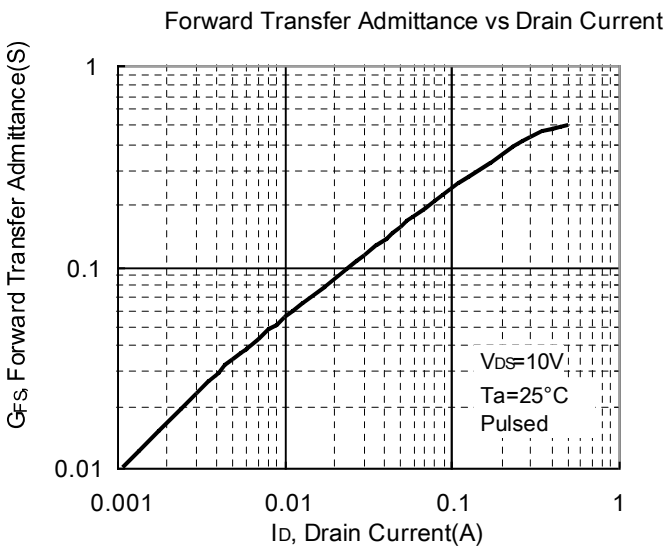
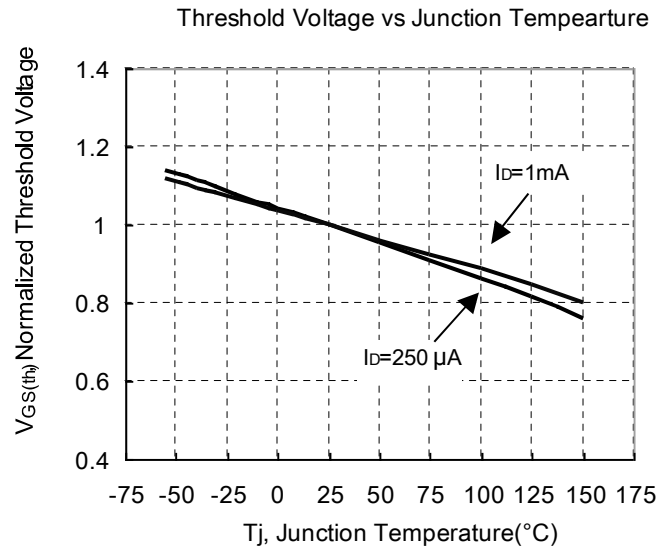
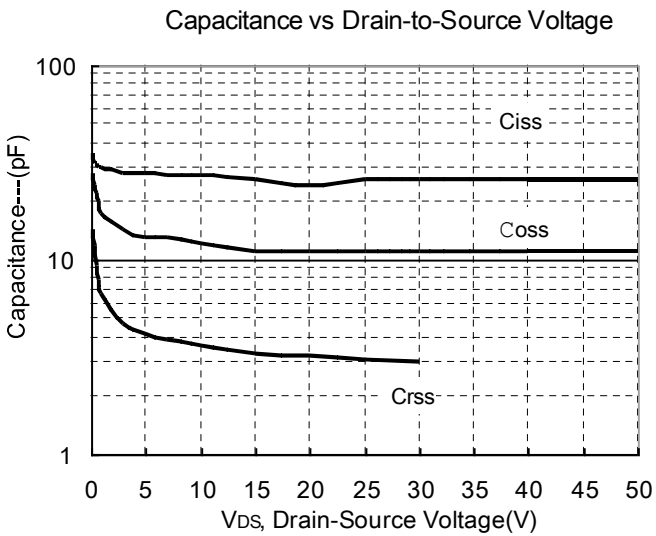

Typical Characteristics (Cont.)

Typical Transfer Characteristics

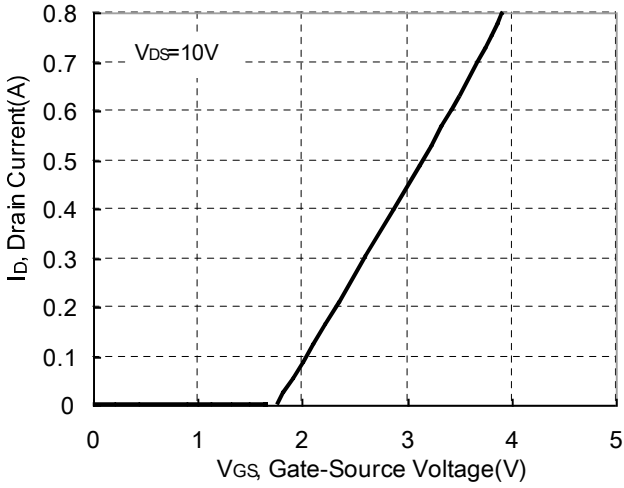

Single Pulse Power Rating, Junction to Ambient
(Note on page 2)

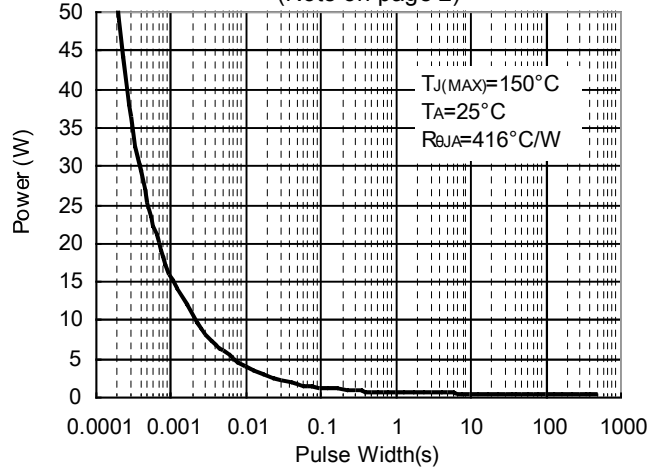

Transient Thermal Response Curves

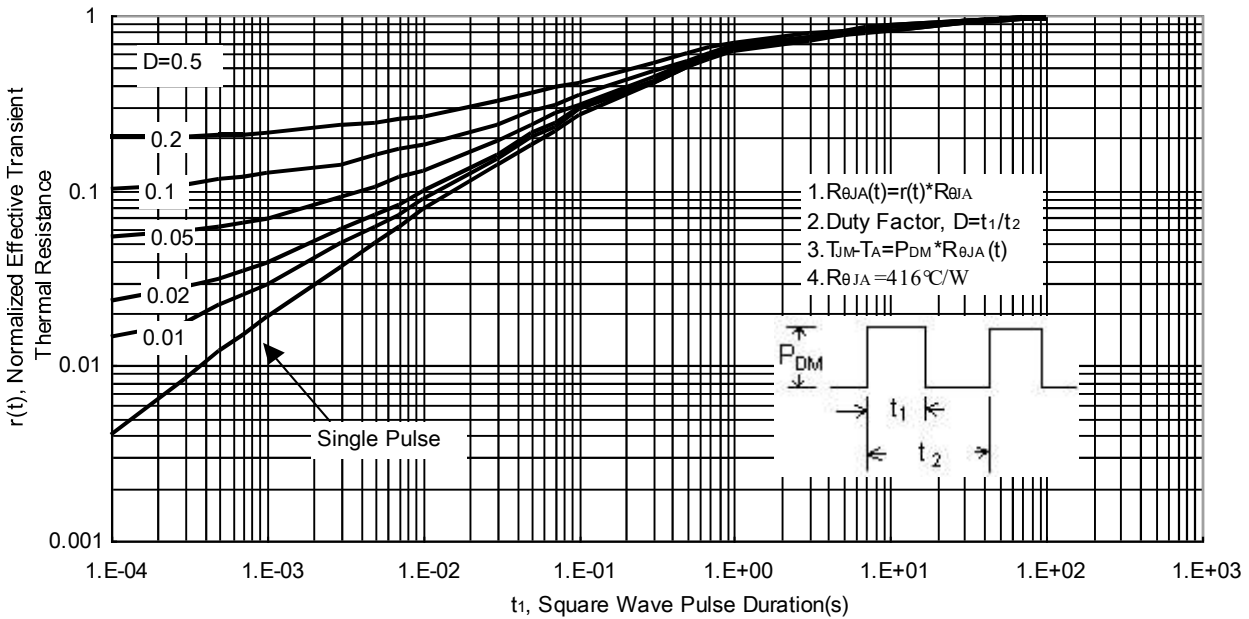

Reel Taping Specification

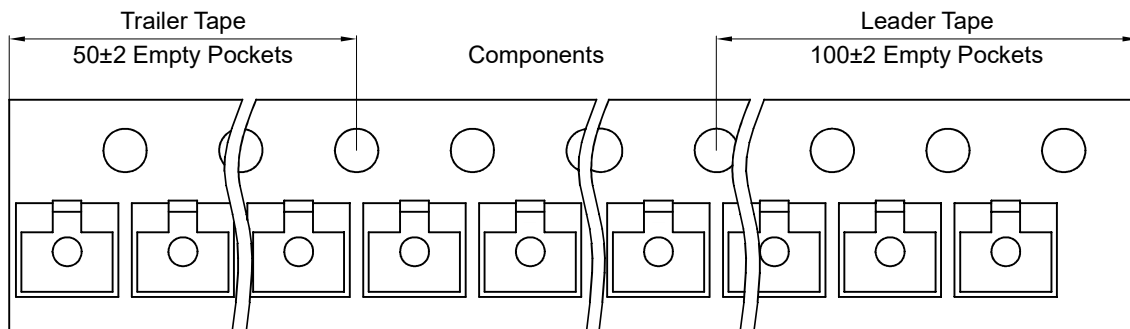
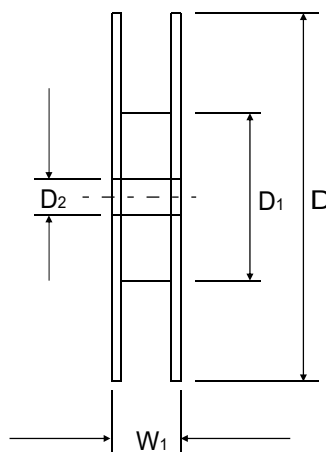
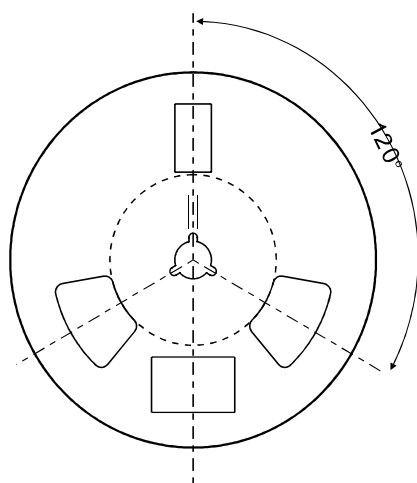
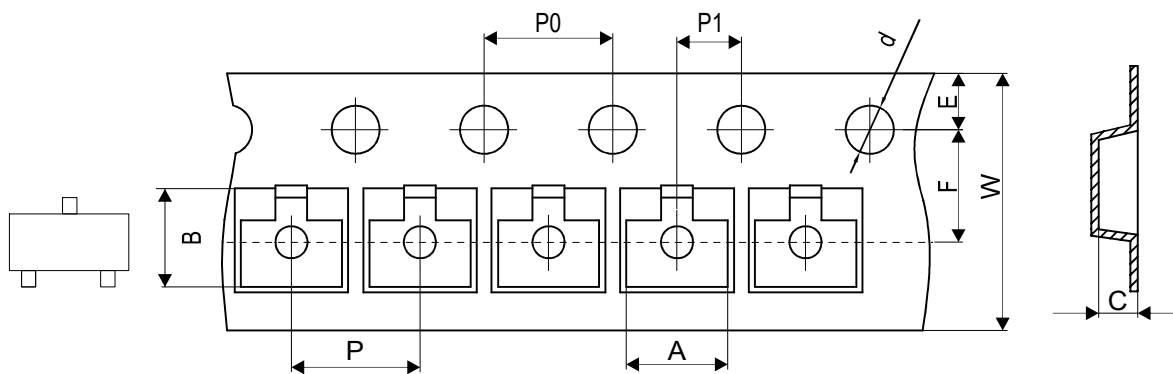

SOT-23	SYMBOL	A	B	C	d	D	D ₁	D ₂
	(mm)	See Note 1			$1.50 + 0.10 - 0.00$	330.00 Max.	50.00 Min.	13.00 ± 0.50
	(inch)	See Note 1			$0.059 + 0.004 - 0.000$	12.992 Max.	1.969 Min.	0.512 ± 0.020

SOT-23	SYMBOL	E	F	P	P ₀	P ₁	W	W ₁
	(mm)	1.75 ± 0.10	3.50 ± 0.05	4.00 ± 0.10	4.00 ± 0.10	2.00 ± 0.10	8.30 Max.	14.40 Max.
	(inch)	0.069 ± 0.004	0.138 ± 0.002	0.157 ± 0.004	0.157 ± 0.004	0.079 ± 0.004	0.327 Max.	0.567 Max.

Note: 1. A, B, and C are determined by component size. The clearance between the components and the cavity must be within 0.05mm min. to 0.50mm max.

Company reserves the right to improve product design, functions and reliability without notice.

Marking Code

Part Number	Marking Code
BSS123T-HF	123BK

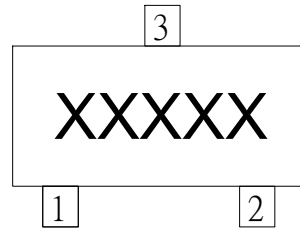

XXXXXX = Product type marking code

Suggested PAD Layout

SIZE	SOT-23	
	(mm)	(inch)
A	0.90	0.035
B	0.80	0.031
C	1.90	0.075
D	2.02	0.080

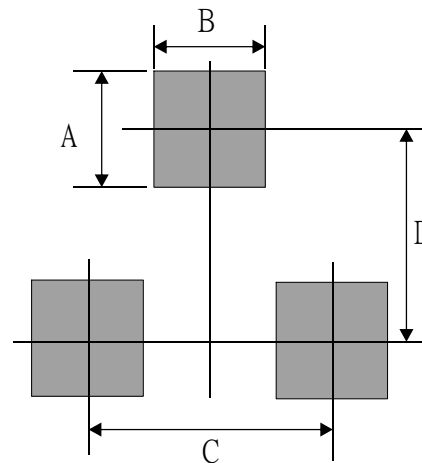

Standard Packaging

Case Type	Qty Per Reel	Reel Size
	(Pcs)	(inch)
SOT-23	3,000	7

Mouser Electronics

Authorized Distributor

Click to View Pricing, Inventory, Delivery & Lifecycle Information:

[Comchip Technology:](#)

[BSS123T-HF](#)