

# BGB707L7ESD

## General purpose LNA MMIC with integrated ESD protection and active biasing



### Product description

The BGB707L7ESD is a high performance low noise amplifier (LNA) MMIC based on Infineon's silicon germanium carbon (SiGe:C) bipolar technology.



### Feature list

- Minimum noise figure  $NF_{min} = 0.6$  dB at 2.4 GHz, 3 V, 3 mA
- Supply voltage  $V_{CC} = 1.8$  V to 4.0 V at  $T_A = 25$  °C
- Integrated ESD protection: 2 kV HBM at all pins

### Product validation

Qualified for industrial applications according to the relevant tests of JEDEC47/20/22.

### Potential applications

- Satellite navigation systems (e.g. GPS, GLONASS, BeiDou, Galileo)
- Wireless communications: WLAN 2.4 GHz and 5-6 GHz bands, broadband LTE or WiMAX LNA
- ISM applications like RKE and smart meter, as well as for emerging wireless applications such as DVB-Terrestrial

### Device information

**Table 1** Part information

Product name / Ordering code	Package	Pin configuration				Marking	Pieces / Reel
BGB707L7ESD / BGB707L7ESDE6327XTSA1	TSLP-7-1	1 = $V_{CC}$	2 = $V_{Bias}$	3 = $RF_{in}$	4 = $RF_{out}$	AZ	7500
		5 = $V_{Ctrl}$	6 = Current adjust	7 = Ground			

**Attention:** ESD (Electrostatic discharge) sensitive device, observe handling precautions

**Functional block diagram**

### Functional block diagram

This functional block diagram explains how the BGB707L7ESD is used. The RF power on/off function is controlled by applying  $V_{Ctrl}$ . By using an external resistor  $R_{ext}$ , the pre-set current of 2.1 mA (when  $R_{ext}$  is omitted) can be increased. Base  $V_B$  and collector  $V_C$  voltages are applied to the respective pins  $RF_{in}$  and  $RF_{out}$  by external inductors  $L_B$  and  $L_C$ .

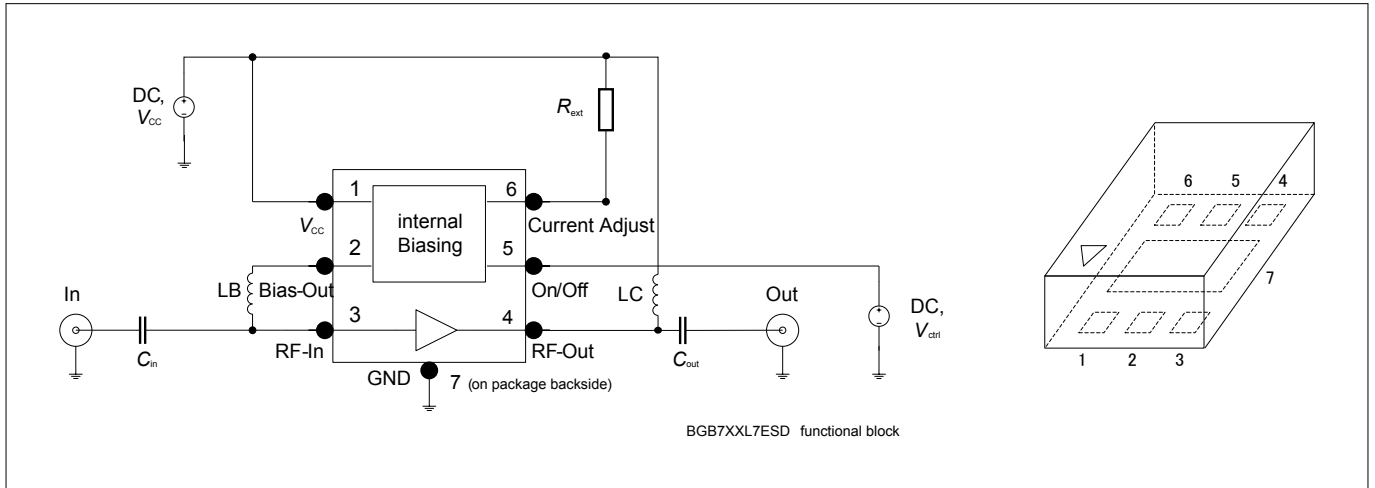

**Figure 1** Functional block diagram

**Table of contents**

	<b>Product description</b> .....	1
	<b>Feature list</b> .....	1
	<b>Product validation</b> .....	1
	<b>Potential applications</b> .....	1
	<b>Device information</b> .....	1
	<b>Functional block diagram</b> .....	2
	<b>Table of contents</b> .....	3
<b>1</b>	<b>Operating conditions</b> .....	4
<b>2</b>	<b>Absolute maximum ratings</b> .....	4
<b>3</b>	<b>Thermal characteristics</b> .....	5
<b>4</b>	<b>Electrical characteristics</b> .....	6
4.1	DC characteristics .....	6
4.2	Characteristic DC diagrams .....	7
4.3	AC characteristics .....	9
4.3.1	AC characteristics in test fixture .....	9
4.3.2	Typical AC characteristic curves .....	19
<b>5</b>	<b>Package information TSLP-7-1</b> .....	24
	<b>Revision history</b> .....	25
	<b>Disclaimer</b> .....	26

## Operating conditions

## 1 Operating conditions

**Table 2** Operation conditions at  $T_A = 25\text{ °C}$ 

Parameter	Symbol	Values			Unit	Note or test condition
		Min.	Typ.	Max.		
Supply voltage	$V_{CC}$	1.8	3	4	V	–
Control voltage in on-mode	$V_{Ctrl-on}$	1.2	–	$V_{CC}$		
Control voltage in off-mode	$V_{Ctrl-off}$	-0.3		0.3		

## 2 Absolute maximum ratings

**Table 3** Absolute maximum ratings at  $T_A = 25\text{ °C}$  (unless otherwise specified)

Parameter	Symbol	Values		Unit	Note or test condition
		Min.	Max.		
Supply voltage	$V_{CC}$	–	4	V	$T_A = 25\text{ °C}$
			3.5		
Supply current	$I_{CC}$		25	mA	–
DC current at $RF_{in}$	$I_B$		2		
Control voltage	$V_{Ctrl}$		4	V	
Total power dissipation <sup>1)</sup>	$P_{tot}$		100	mW	$T_S \leq 112\text{ °C}$
Junction temperature	$T_J$		150	°C	–
Storage temperature	$T_{Stg}$	-55			

**Attention:** Stresses above the max. values listed here may cause permanent damage to the device. Exposure to absolute maximum rating conditions for extended periods may affect device reliability. Exceeding only one of these values may cause irreversible damage to the integrated circuit.

<sup>1)</sup>  $T_S$  is the soldering point temperature.  $T_S$  is measured on the emitter lead at the soldering point of the PCB.

### 3 Thermal characteristics

Table 4 Thermal resistance

Parameter	Symbol	Values			Unit	Note or test condition
		Min.	Typ.	Max.		
Junction - soldering point	$R_{thJS}$	-	375	-	K/W	-

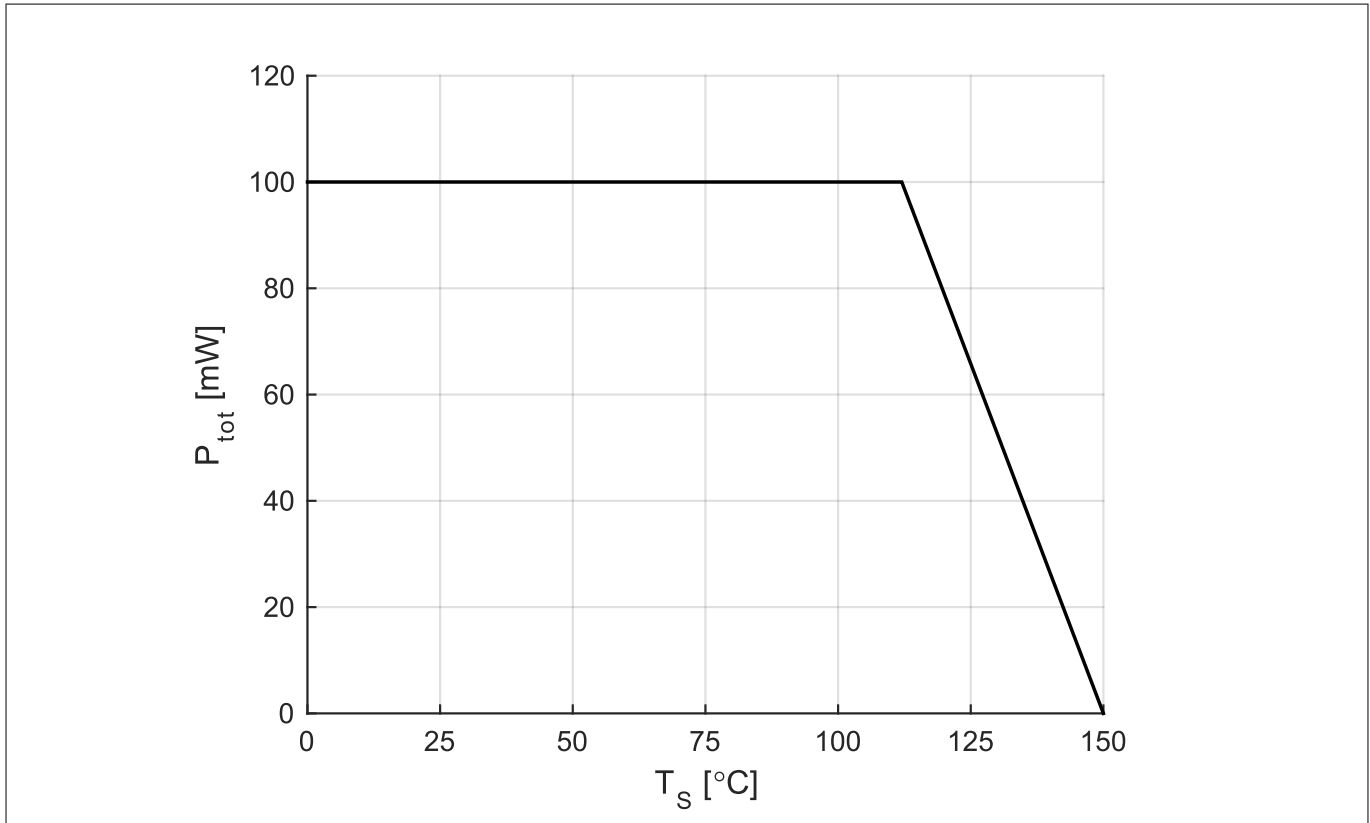

Figure 2 Total power dissipation  $P_{tot} = f(T_S)$

**Electrical characteristics**

**4 Electrical characteristics**

**4.1 DC characteristics**

**Table 5 DC characteristics at  $V_{CC} = 3\text{ V}$ ,  $T_A = 25\text{ °C}$**

Parameter	Symbol	Values			Unit	Note or test condition
		Min.	Typ.	Max.		
Supply current in on-mode	$I_{CC-on}$	1.6	2.1	2.6	mA	$V_{Ctrl} = 3\text{ V}$ $R_{ext} = \text{open}$ $R_{ext} = 12\text{ k}\Omega$ $R_{ext} = 4.7\text{ k}\Omega$ $R_{ext} = 2.4\text{ k}\Omega$ $R_{ext} = 1\text{ k}\Omega$
		-	3	-		
		-	4.2	-		
		-	6	-		
		-	10	-		
		-	-	-		
Supply current in off-mode	$I_{CC-off}$	-	-	6	$\mu\text{A}$	$V_{Ctrl} = 0\text{ V}$
Control current in on-mode	$I_{Ctrl-on}$	-	14	20		$V_{Ctrl} = 3\text{ V}$
Control current in off-mode	$I_{Ctrl-off}$	-	-	0.1		$V_{Ctrl} = 0\text{ V}$

Electrical characteristics

4.2 Characteristic DC diagrams

The measurement setup is an application circuit according to Figure 1 on page 2, using the integrated biasing.  $T_A = 25\text{ }^\circ\text{C}$  (unless otherwise specified).

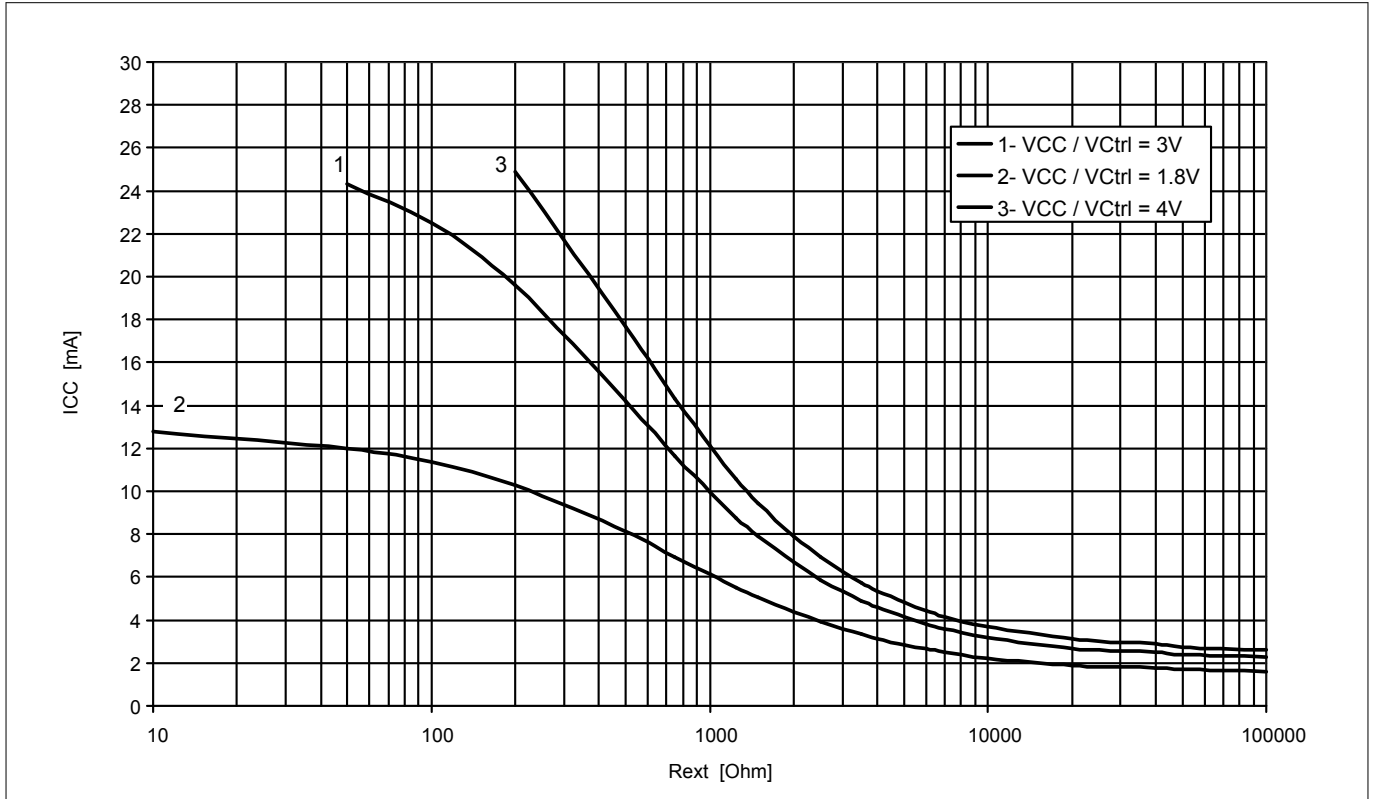

Figure 3 Supply current vs external resistance  $I_{CC} = f(R_{ext}), V_{CC} / V_{ctrl} = \text{parameter}$

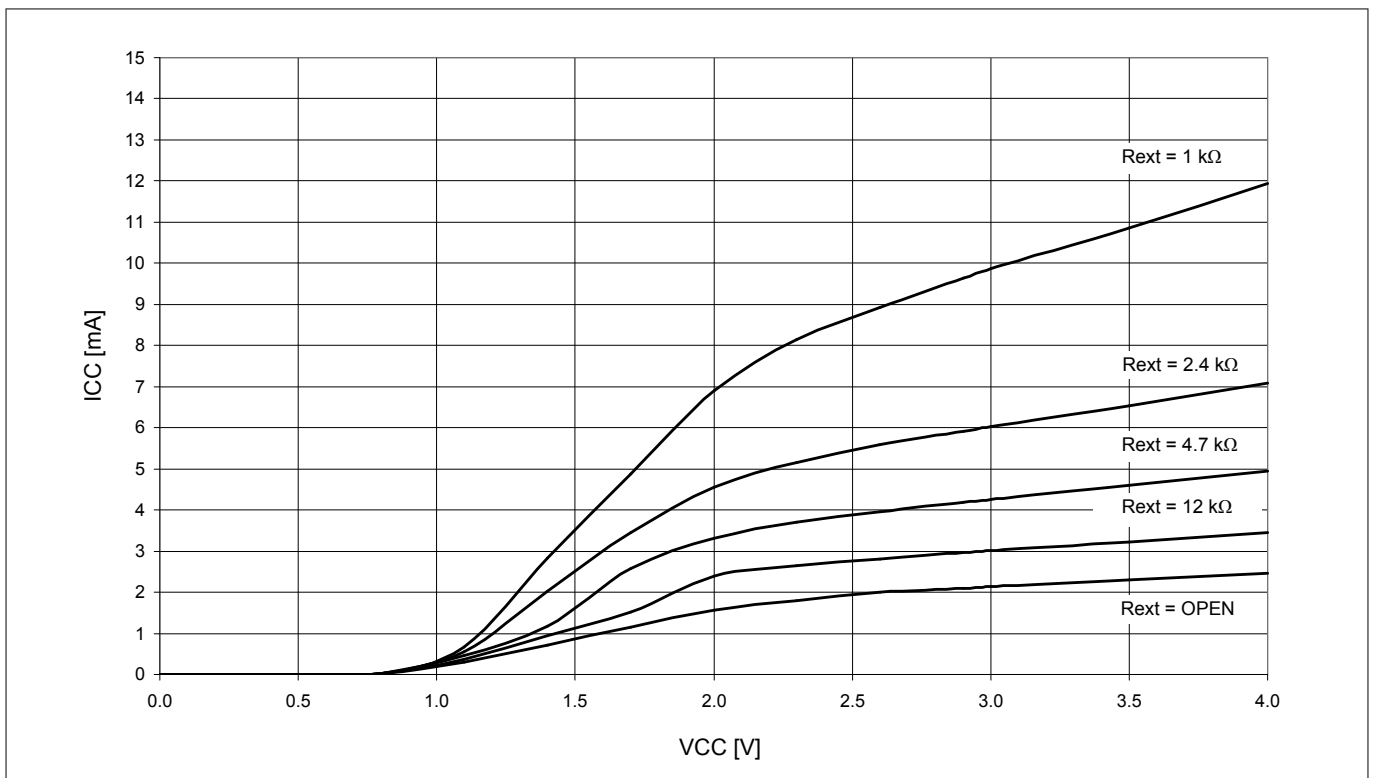

Figure 4 Supply current vs supply voltage  $I_{CC} = f(V_{CC}), V_{ctrl} = 3V, R_{ext} = \text{parameter}$

Electrical characteristics

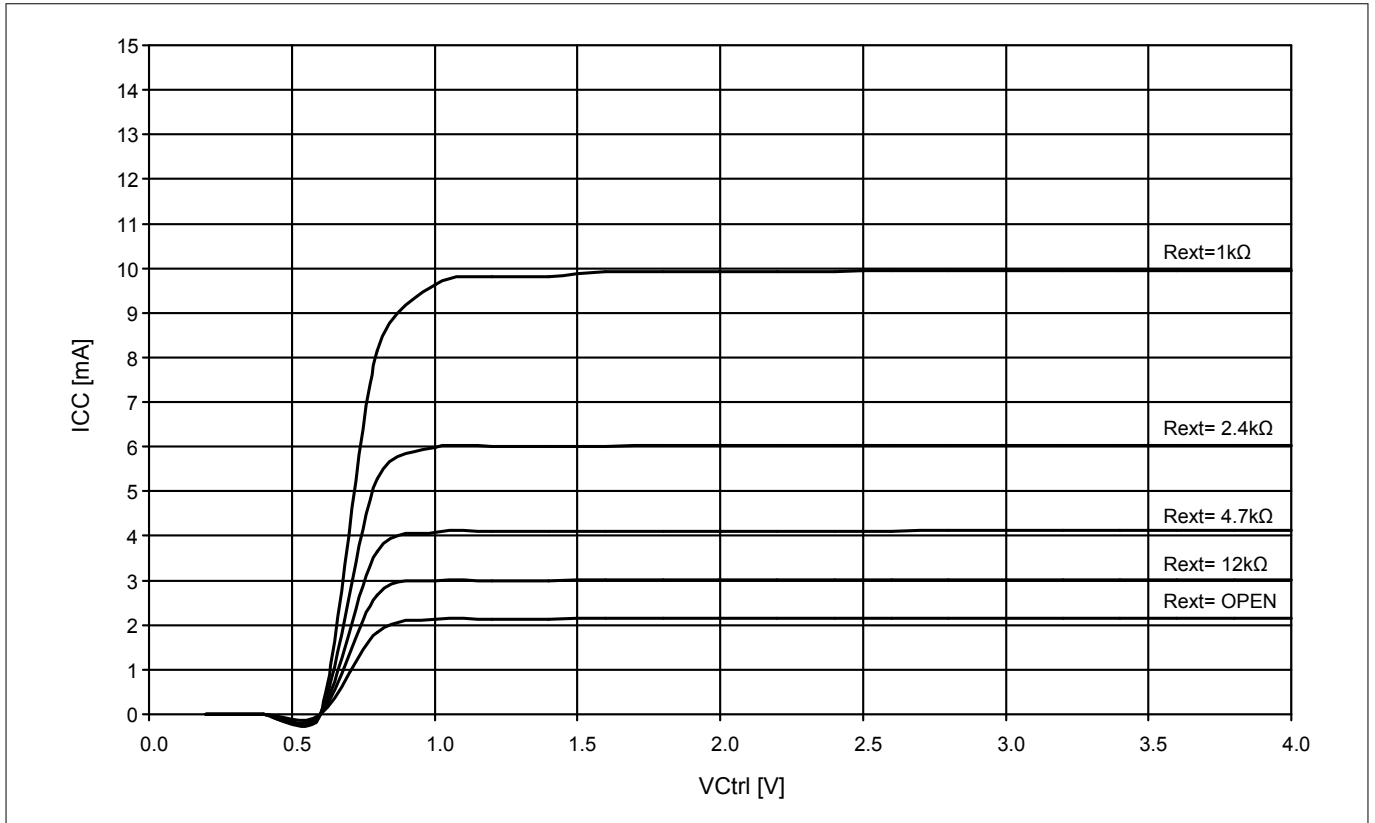

Figure 5 Supply current vs control voltage  $I_{CC} = f(V_{Ctrl})$ ,  $V_{CC} = 3 V$ ,  $R_{ext} = \text{parameter}$

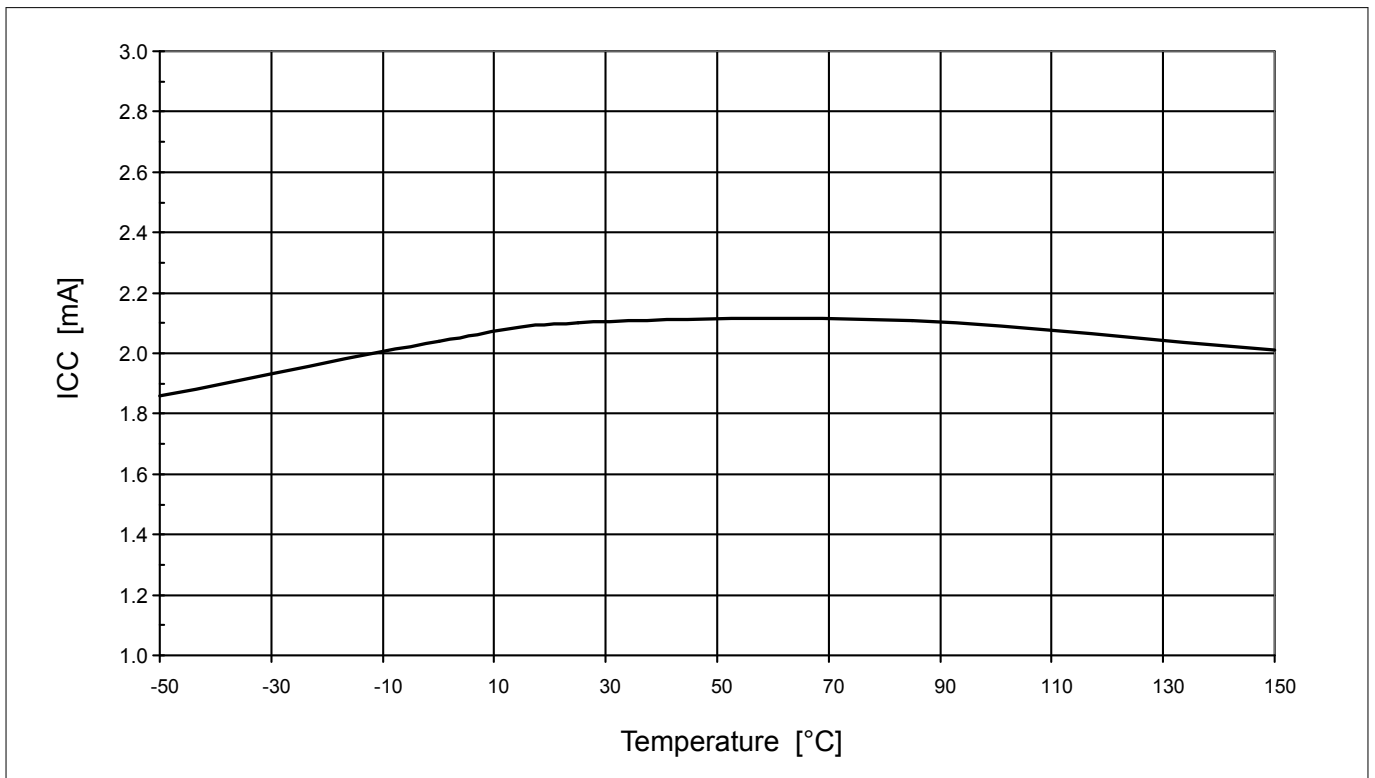

Figure 6 Supply current vs temperature  $I_{CC} = f(T_A)$ ,  $V_{Ctrl} = V_{CC} = 3 V$ ,  $R_{ext} = \text{open}$



**Electrical characteristics**

**4.3 AC characteristics**

AC characteristics are described for higher frequencies in a 50 Ω environment.

**4.3.1 AC characteristics in test fixture**

Measurement setup is a test fixture with Bias-T's in a 50 Ω system according to Figure 7, for frequencies  $f$  from 150 MHz to 10 GHz at  $V_C = 3\text{ V}$ ,  $T_A = 25\text{ °C}$ . The collector current  $I_C$  is controlled by the external base voltage  $V_B$ . Which is not dependent of the biasing reference voltage  $V_{Bias}$ . The bias voltage  $V_C$  at the output  $RF_{out}$  allows direct measurement of the amplifier performance, as a function of bias conditions without passive components.

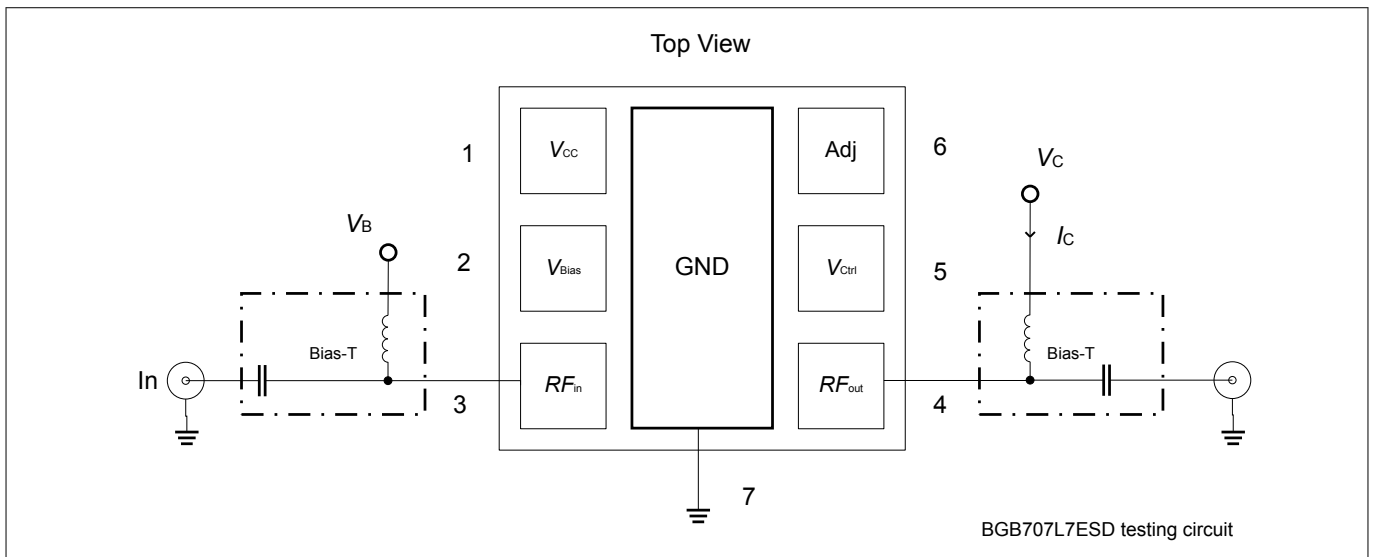

**Figure 7 Testing circuit for frequencies  $f$  from 150 MHz to 10 GHz**

## Electrical characteristics

Table 6 AC characteristics,  $V_C = 3\text{ V}$ ,  $f = 150\text{ MHz}$ 

Parameter	Symbol	Values			Unit	Note or test conditions	
		Min.	Typ.	Max.			
Minimum noise figure	$NF_{\min}$	–	0.4 0.4 0.5 0.55	–	dB	$I_C = 2.1\text{ mA}$ $I_C = 3\text{ mA}$ $I_C = 6\text{ mA}$ $I_C = 10\text{ mA}$	
Transducer gain	$ S_{21} ^2$		17 19 24 27			$I_C = 2.1\text{ mA}$ $I_C = 3\text{ mA}$ $I_C = 6\text{ mA}$ $I_C = 10\text{ mA}$	
Maximum power gain	$G_{\text{ms}}$		31.5 33 35 37			$I_C = 2.1\text{ mA}$ $I_C = 3\text{ mA}$ $I_C = 6\text{ mA}$ $I_C = 10\text{ mA}$	
Output 1 dB gain compression point <sup>2)</sup>	$OP_{1\text{dB}}$		3.5 4 4.5 3			dBm	$I_{Cq} = 2.1\text{ mA}$ , $I_{C\text{comp}} = 11\text{ mA}$ <sup>3)</sup> $I_{Cq} = 3\text{ mA}$ , $I_{C\text{comp}} = 11\text{ mA}$ $I_{Cq} = 6\text{ mA}$ , $I_{C\text{comp}} = 11\text{ mA}$ $I_{Cq} = 10\text{ mA}$ , $I_{C\text{comp}} = 11\text{ mA}$
Output 3 <sup>rd</sup> order intercept point	$OIP_3$		2 6 14.5 19.5				$I_C = 2.1\text{ mA}$ $I_C = 3\text{ mA}$ $I_C = 6\text{ mA}$ $I_C = 10\text{ mA}$

<sup>2)</sup>  $OP_{1\text{dB}}$  is the output compression point achieved in a  $50\ \Omega$  application circuit according to Figure 1 using the integrated biasing.

<sup>3)</sup>  $I_{Cq}$  is the quiescent current at small input power levels.  $I_{Cq}$  increases up to  $I_{C\text{comp}}$  as RF input power approaches  $IP_{1\text{dB}}$ , cf. Figure 14.

## Electrical characteristics

Table 7 AC characteristics,  $V_C = 3\text{ V}$ ,  $f = 450\text{ MHz}$ 

Parameter	Symbol	Values			Unit	Note or test conditions	
		Min.	Typ.	Max.			
Minimum noise figure	$NF_{\min}$	–	0.45 0.45 0.5 0.6	–	dB	$I_C = 2.1\text{ mA}$ $I_C = 3\text{ mA}$ $I_C = 6\text{ mA}$ $I_C = 10\text{ mA}$	
Transducer gain	$ S_{21} ^2$		17 19 24 27			$I_C = 2.1\text{ mA}$ $I_C = 3\text{ mA}$ $I_C = 6\text{ mA}$ $I_C = 10\text{ mA}$	
Maximum power gain	$G_{\text{ms}}$		27 28 30.5 32			$I_C = 2.1\text{ mA}$ $I_C = 3\text{ mA}$ $I_C = 6\text{ mA}$ $I_C = 10\text{ mA}$	
Output 1 dB gain compression point <sup>2)</sup>	$OP_{1\text{dB}}$		11.5 12 11.5 9.5			dBm	$I_{Cq} = 2.1\text{ mA}$ , $I_{C\text{comp}} = 11\text{ mA}$ <sup>3)</sup> $I_{Cq} = 3\text{ mA}$ , $I_{C\text{comp}} = 14\text{ mA}$ $I_{Cq} = 6\text{ mA}$ , $I_{C\text{comp}} = 16\text{ mA}$ $I_{Cq} = 10\text{ mA}$ , $I_{C\text{comp}} = 15\text{ mA}$
Output 3 <sup>rd</sup> order intercept point	$OIP_3$		2 5.5 14 19.5				$I_C = 2.1\text{ mA}$ $I_C = 3\text{ mA}$ $I_C = 6\text{ mA}$ $I_C = 10\text{ mA}$

<sup>2)</sup>  $OP_{1\text{dB}}$  is the output compression point achieved in a  $50\ \Omega$  application circuit according to Figure 1 using the integrated biasing.

<sup>3)</sup>  $I_{Cq}$  is the quiescent current at small input power levels.  $I_{Cq}$  increases up to  $I_{C\text{comp}}$  as RF input power approaches  $IP_{1\text{dB}}$ , cf. Figure 14.

## Electrical characteristics

Table 8 AC characteristics,  $V_C = 3\text{ V}$ ,  $f = 900\text{ MHz}$ 

Parameter	Symbol	Values			Unit	Note or test conditions	
		Min.	Typ.	Max.			
Minimum noise figure	$NF_{\min}$	–	0.55 0.55 0.6 0.7	–	dB	$I_C = 2.1\text{ mA}$ $I_C = 3\text{ mA}$ $I_C = 6\text{ mA}$ $I_C = 10\text{ mA}$	
Transducer gain	$ S_{21} ^2$		17 19 23.5 26			$I_C = 2.1\text{ mA}$ $I_C = 3\text{ mA}$ $I_C = 6\text{ mA}$ $I_C = 10\text{ mA}$	
Maximum power gain	$G_{\text{ms}}$		24 25 27.5 29			$I_C = 2.1\text{ mA}$ $I_C = 3\text{ mA}$ $I_C = 6\text{ mA}$ $I_C = 10\text{ mA}$	
Output 1 dB gain compression point <sup>2)</sup>	$OP_{1\text{dB}}$		11 11 10 8.5			dBm	$I_{Cq} = 2.1\text{ mA}$ , $I_{C\text{comp}} = 13\text{ mA}$ <sup>3)</sup> $I_{Cq} = 3\text{ mA}$ , $I_{C\text{comp}} = 15\text{ mA}$ $I_{Cq} = 6\text{ mA}$ , $I_{C\text{comp}} = 14\text{ mA}$ $I_{Cq} = 10\text{ mA}$ , $I_{C\text{comp}} = 14\text{ mA}$
Output 3 <sup>rd</sup> order intercept point	$OIP_3$		3.5 8 17 19.5				$I_C = 2.1\text{ mA}$ $I_C = 3\text{ mA}$ $I_C = 6\text{ mA}$ $I_C = 10\text{ mA}$

<sup>2)</sup>  $OP_{1\text{dB}}$  is the output compression point achieved in a  $50\ \Omega$  application circuit according to Figure 1 using the integrated biasing.

<sup>3)</sup>  $I_{Cq}$  is the quiescent current at small input power levels.  $I_{Cq}$  increases up to  $I_{C\text{comp}}$  as RF input power approaches  $IP_{1\text{dB}}$ , cf. Figure 14.

## Electrical characteristics

Table 9 AC characteristics,  $V_C = 3\text{ V}$ ,  $f = 1.5\text{ GHz}$ 

Parameter	Symbol	Values			Unit	Note or test conditions	
		Min.	Typ.	Max.			
Minimum noise figure	$NF_{\min}$	–	0.6 0.6 0.6 0.7	–	dB	$I_C = 2.1\text{ mA}$ $I_C = 3\text{ mA}$ $I_C = 6\text{ mA}$ $I_C = 10\text{ mA}$	
Transducer gain	$ S_{21} ^2$		16 18.5 22.5 24.5			$I_C = 2.1\text{ mA}$ $I_C = 3\text{ mA}$ $I_C = 6\text{ mA}$ $I_C = 10\text{ mA}$	
Maximum power gain	$G_{\text{ms}}$		21.5 23 25.5 27			$I_C = 2.1\text{ mA}$ $I_C = 3\text{ mA}$ $I_C = 6\text{ mA}$ $I_C = 10\text{ mA}$	
Output 1 dB gain compression point <sup>2)</sup>	$OP_{1\text{dB}}$		10.5 10 9 8			dBm	$I_{Cq} = 2.1\text{ mA}$ , $I_{C\text{comp}} = 14\text{ mA}$ <sup>3)</sup> $I_{Cq} = 3\text{ mA}$ , $I_{C\text{comp}} = 16\text{ mA}$ $I_{Cq} = 6\text{ mA}$ , $I_{C\text{comp}} = 15\text{ mA}$ $I_{Cq} = 10\text{ mA}$ , $I_{C\text{comp}} = 15\text{ mA}$
Output 3 <sup>rd</sup> order intercept point	$OIP_3$		3.5 8 17 19.5				$I_C = 2.1\text{ mA}$ $I_C = 3\text{ mA}$ $I_C = 6\text{ mA}$ $I_C = 10\text{ mA}$

<sup>2)</sup>  $OP_{1\text{dB}}$  is the output compression point achieved in a  $50\ \Omega$  application circuit according to Figure 1 using the integrated biasing.

<sup>3)</sup>  $I_{Cq}$  is the quiescent current at small input power levels.  $I_{Cq}$  increases up to  $I_{C\text{comp}}$  as RF input power approaches  $IP_{1\text{dB}}$ , cf. Figure 14.

## Electrical characteristics

Table 10 AC characteristics,  $V_C = 3\text{ V}$ ,  $f = 1.9\text{ GHz}$ 

Parameter	Symbol	Values			Unit	Note or test conditions	
		Min.	Typ.	Max.			
Minimum noise figure	$NF_{\min}$	–	0.6 0.6 0.6 0.7	–	dB	$I_C = 2.1\text{ mA}$ $I_C = 3\text{ mA}$ $I_C = 6\text{ mA}$ $I_C = 10\text{ mA}$	
Transducer gain	$ S_{21} ^2$		16 18 21.5 23			$I_C = 2.1\text{ mA}$ $I_C = 3\text{ mA}$ $I_C = 6\text{ mA}$ $I_C = 10\text{ mA}$	
Maximum power gain	$G_{\text{ms}}$		21 22 24 26			$I_C = 2.1\text{ mA}$ $I_C = 3\text{ mA}$ $I_C = 6\text{ mA}$ $I_C = 10\text{ mA}$	
Output 1 dB gain compression point <sup>2)</sup>	$OP_{1\text{dB}}$		10 10 8.5 8			dBm	$I_{Cq} = 2.1\text{ mA}$ , $I_{C\text{comp}} = 15\text{ mA}$ <sup>3)</sup> $I_{Cq} = 3\text{ mA}$ , $I_{C\text{comp}} = 16\text{ mA}$ $I_{Cq} = 6\text{ mA}$ , $I_{C\text{comp}} = 14\text{ mA}$ $I_{Cq} = 10\text{ mA}$ , $I_{C\text{comp}} = 14\text{ mA}$
Output 3 <sup>rd</sup> order intercept point	$OIP_3$		3.5 7.5 17 19.5				$I_C = 2.1\text{ mA}$ $I_C = 3\text{ mA}$ $I_C = 6\text{ mA}$ $I_C = 10\text{ mA}$

<sup>2)</sup>  $OP_{1\text{dB}}$  is the output compression point achieved in a  $50\ \Omega$  application circuit according to Figure 1 using the integrated biasing.

<sup>3)</sup>  $I_{Cq}$  is the quiescent current at small input power levels.  $I_{Cq}$  increases up to  $I_{C\text{comp}}$  as RF input power approaches  $IP_{1\text{dB}}$ , cf. Figure 14.

## Electrical characteristics

Table 11 AC characteristics,  $V_C = 3\text{ V}$ ,  $f = 2.4\text{ GHz}$ 

Parameter	Symbol	Values			Unit	Note or test conditions	
		Min.	Typ.	Max.			
Minimum noise figure	$NF_{\min}$	–	0.65 0.6 0.6 0.7	–	dB	$I_C = 2.1\text{ mA}$ $I_C = 3\text{ mA}$ $I_C = 6\text{ mA}$ $I_C = 10\text{ mA}$	
Transducer gain	$ S_{21} ^2$		15.5 17 20 21.5			$I_C = 2.1\text{ mA}$ $I_C = 3\text{ mA}$ $I_C = 6\text{ mA}$ $I_C = 10\text{ mA}$	
Maximum power gain	$G_{\text{ms}}$		20 21 23 25			$I_C = 2.1\text{ mA}$ $I_C = 3\text{ mA}$ $I_C = 6\text{ mA}$ $I_C = 10\text{ mA}$	
Output 1 dB gain compression point <sup>2)</sup>	$OP_{1\text{dB}}$		10 10 9 8			dBm	$I_{Cq} = 2.1\text{ mA}$ , $I_{C\text{comp}} = 15\text{ mA}$ <sup>3)</sup> $I_{Cq} = 3\text{ mA}$ , $I_{C\text{comp}} = 16\text{ mA}$ $I_{Cq} = 6\text{ mA}$ , $I_{C\text{comp}} = 14\text{ mA}$ $I_{Cq} = 10\text{ mA}$ , $I_{C\text{comp}} = 14\text{ mA}$
Output 3 <sup>rd</sup> order intercept point	$OIP_3$		4.5 9 17.5 19.5				$I_C = 2.1\text{ mA}$ $I_C = 3\text{ mA}$ $I_C = 6\text{ mA}$ $I_C = 10\text{ mA}$

<sup>2)</sup>  $OP_{1\text{dB}}$  is the output compression point achieved in a  $50\ \Omega$  application circuit according to Figure 1 using the integrated biasing.

<sup>3)</sup>  $I_{Cq}$  is the quiescent current at small input power levels.  $I_{Cq}$  increases up to  $I_{C\text{comp}}$  as RF input power approaches  $IP_{1\text{dB}}$ , cf. Figure 14.

## Electrical characteristics

Table 12 AC characteristics,  $V_C = 3\text{ V}$ ,  $f = 3.5\text{ GHz}$ 

Parameter	Symbol	Values			Unit	Note or test conditions
		Min.	Typ.	Max.		
Minimum noise figure	$NF_{\min}$	–	0.8 0.75 0.7 0.75	–	dB	$I_C = 2.1\text{ mA}$ $I_C = 3\text{ mA}$ $I_C = 6\text{ mA}$ $I_C = 10\text{ mA}$
Transducer gain	$ S_{21} ^2$		13.5 15.5 18 19			$I_C = 2.1\text{ mA}$ $I_C = 3\text{ mA}$ $I_C = 6\text{ mA}$ $I_C = 10\text{ mA}$
Maximum power gain	$G_{\text{ms}}$		18.5 20 22 23.5			$I_C = 2.1\text{ mA}$ $I_C = 3\text{ mA}$ $I_C = 6\text{ mA}$ $I_C = 10\text{ mA}$
Output 1 dB gain compression point <sup>2)</sup>	$OP_{1\text{dB}}$		10 10 9 8			dBm
Output 3 <sup>rd</sup> order intercept point	$OIP_3$		5.5 12 17.5 19		$I_C = 2.1\text{ mA}$ $I_C = 3\text{ mA}$ $I_C = 6\text{ mA}$ $I_C = 10\text{ mA}$	

<sup>2)</sup>  $OP_{1\text{dB}}$  is the output compression point achieved in a  $50\ \Omega$  application circuit according to Figure 1 using the integrated biasing.

<sup>3)</sup>  $I_{Cq}$  is the quiescent current at small input power levels.  $I_{Cq}$  increases up to  $I_{C\text{comp}}$  as RF input power approaches  $IP_{1\text{dB}}$ , cf. Figure 14.



## Electrical characteristics

Table 13 AC characteristics,  $V_C = 3\text{ V}$ ,  $f = 5.5\text{ GHz}$ 

Parameter	Symbol	Values			Unit	Note or test conditions	
		Min.	Typ.	Max.			
Minimum noise figure	$NF_{\min}$	–	1.05 1 0.9 0.95	–	dB	$I_C = 2.1\text{ mA}$ $I_C = 3\text{ mA}$ $I_C = 6\text{ mA}$ $I_C = 10\text{ mA}$	
Transducer gain	$ S_{21} ^2$		11.5 13 15 15.5			$I_C = 2.1\text{ mA}$ $I_C = 3\text{ mA}$ $I_C = 6\text{ mA}$ $I_C = 10\text{ mA}$	
Maximum power gain	$G_{\text{ms}}$		17.5 18.5 20 19			$I_C = 2.1\text{ mA}$ $I_C = 3\text{ mA}$ $I_C = 6\text{ mA}$ $I_C = 10\text{ mA}$	
Output 1 dB gain compression point <sup>2)</sup>	$OP_{1\text{dB}}$		10.5 10 9 8			dBm	$I_{Cq} = 2.1\text{ mA}$ , $I_{C\text{comp}} = 17\text{ mA}$ <sup>3)</sup> $I_{Cq} = 3\text{ mA}$ , $I_{C\text{comp}} = 17\text{ mA}$ $I_{Cq} = 6\text{ mA}$ , $I_{C\text{comp}} = 15\text{ mA}$ $I_{Cq} = 10\text{ mA}$ , $I_{C\text{comp}} = 15\text{ mA}$
Output 3 <sup>rd</sup> order intercept point	$OIP_3$		6.5 12 22 21				$I_C = 2.1\text{ mA}$ $I_C = 3\text{ mA}$ $I_C = 6\text{ mA}$ $I_C = 10\text{ mA}$

<sup>2)</sup>  $OP_{1\text{dB}}$  is the output compression point achieved in a  $50\ \Omega$  application circuit according to Figure 1 using the integrated biasing.

<sup>3)</sup>  $I_{Cq}$  is the quiescent current at small input power levels.  $I_{Cq}$  increases up to  $I_{C\text{comp}}$  as RF input power approaches  $IP_{1\text{dB}}$ , cf. Figure 14.

## Electrical characteristics

Table 14 AC characteristics,  $V_C = 3\text{ V}$ ,  $f = 10\text{ GHz}$ 

Parameter	Symbol	Values			Unit	Note or test conditions
		Min.	Typ.	Max.		
Minimum noise figure	$NF_{\min}$	–	2 1.8 1.5 1.5	–	dB	$I_C = 2.1\text{ mA}$ $I_C = 3\text{ mA}$ $I_C = 6\text{ mA}$ $I_C = 10\text{ mA}$
Transducer gain	$ S_{21} ^2$		5.5 7 9 10			$I_C = 2.1\text{ mA}$ $I_C = 3\text{ mA}$ $I_C = 6\text{ mA}$ $I_C = 10\text{ mA}$
Maximum power gain	$G_{\text{ms}}$		14.5 15 15.5 15.5			$I_C = 2.1\text{ mA}$ $I_C = 3\text{ mA}$ $I_C = 6\text{ mA}$ $I_C = 10\text{ mA}$
Output 1 dB gain compression point <sup>2)</sup>	$OP_{1\text{dB}}$		6 6 4 4			dBm
Output 3 <sup>rd</sup> order intercept point	$OIP_3$		2.5 7 19.5 18		$I_C = 2.1\text{ mA}$ $I_C = 3\text{ mA}$ $I_C = 6\text{ mA}$ $I_C = 10\text{ mA}$	

<sup>2)</sup>  $OP_{1\text{dB}}$  is the output compression point achieved in a  $50\ \Omega$  application circuit according to Figure 1 using the integrated biasing.

<sup>3)</sup>  $I_{Cq}$  is the quiescent current at small input power levels.  $I_{Cq}$  increases up to  $I_{C\text{comp}}$  as RF input power approaches  $IP_{1\text{dB}}$ , cf. Figure 14.

Electrical characteristics

4.3.2 Typical AC characteristic curves

Measurement setup is as described in Figure 7 except for Figure 14, where the compression point is measured in a 50 Ω application circuit according to Figure 1 using the integrated biasing at  $V_C = 3\text{ V}$ ,  $T_A = 25\text{ °C}$ .

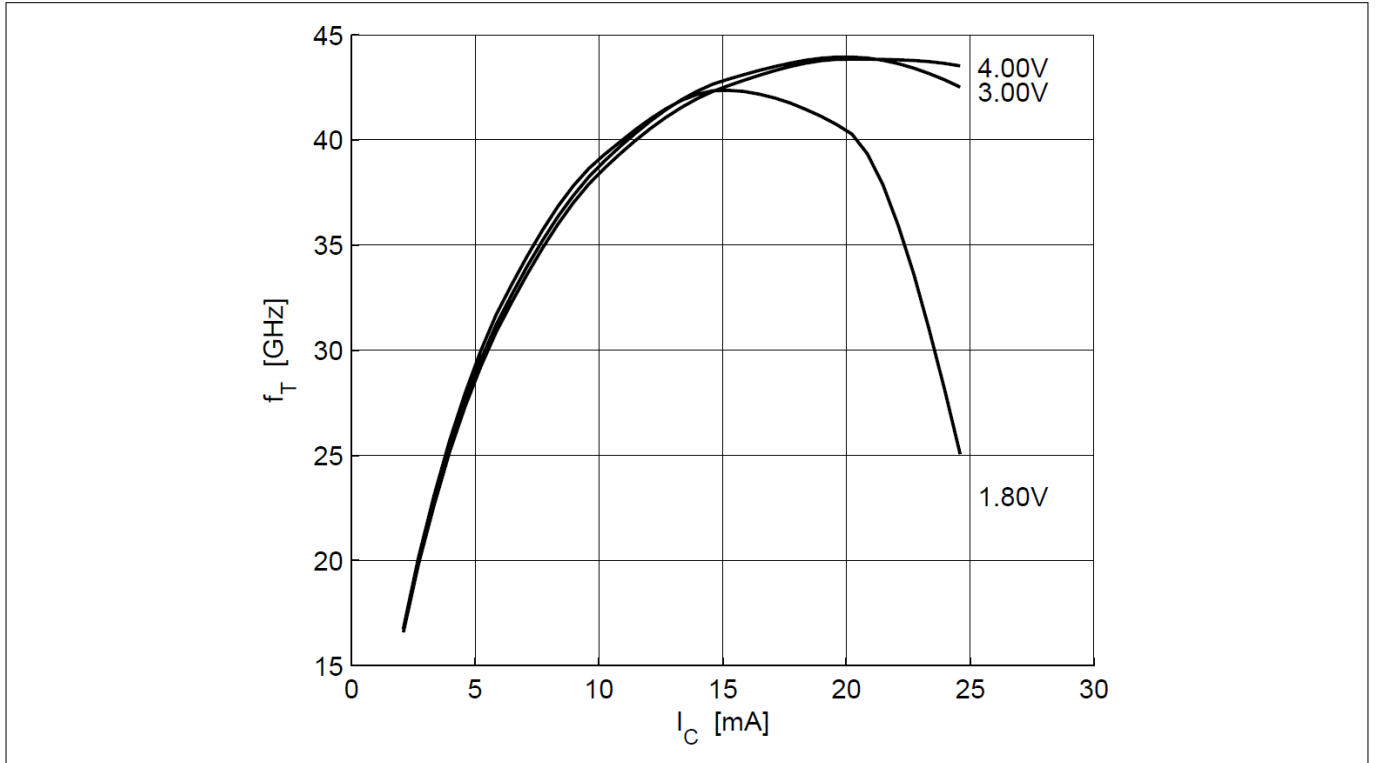

Figure 8 Transition frequency  $f_T = f(I_C)$ ,  $V_C = \text{parameter}$

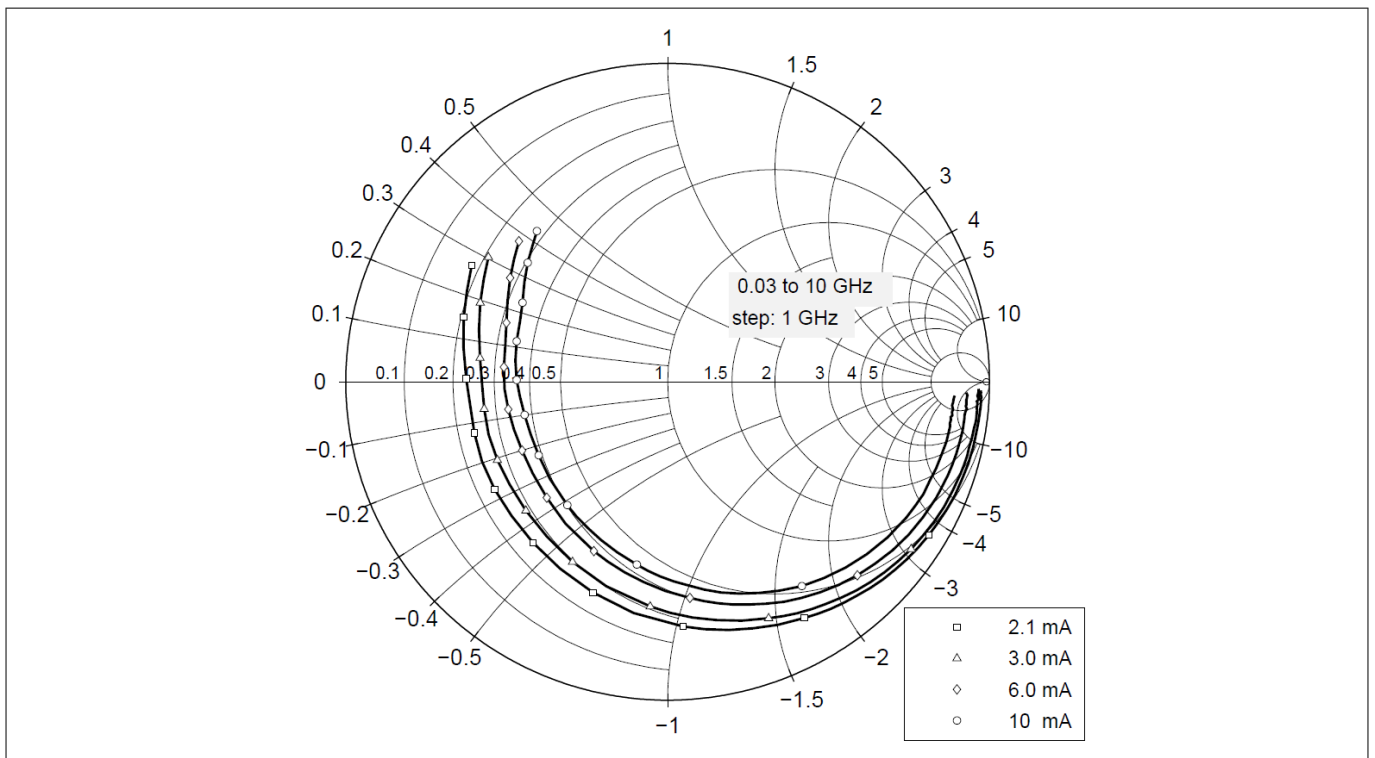
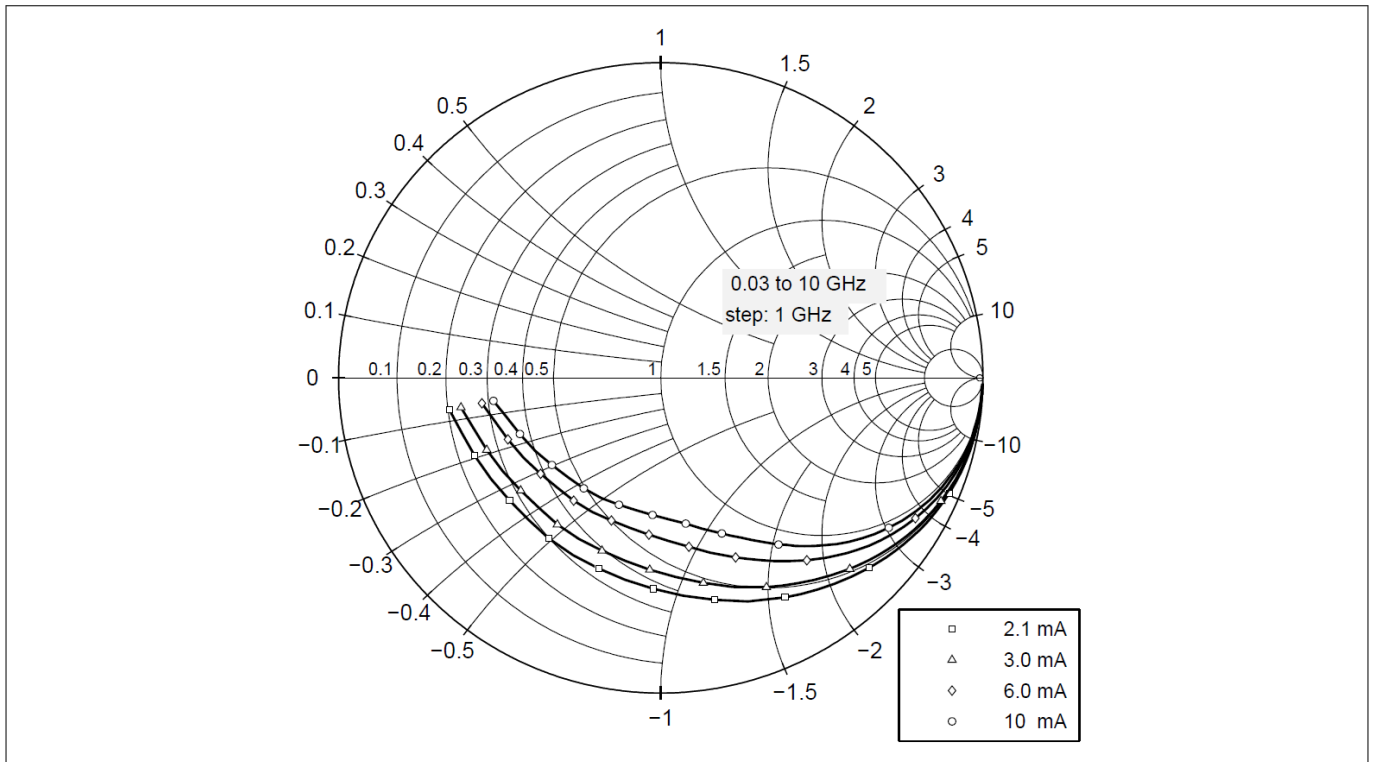
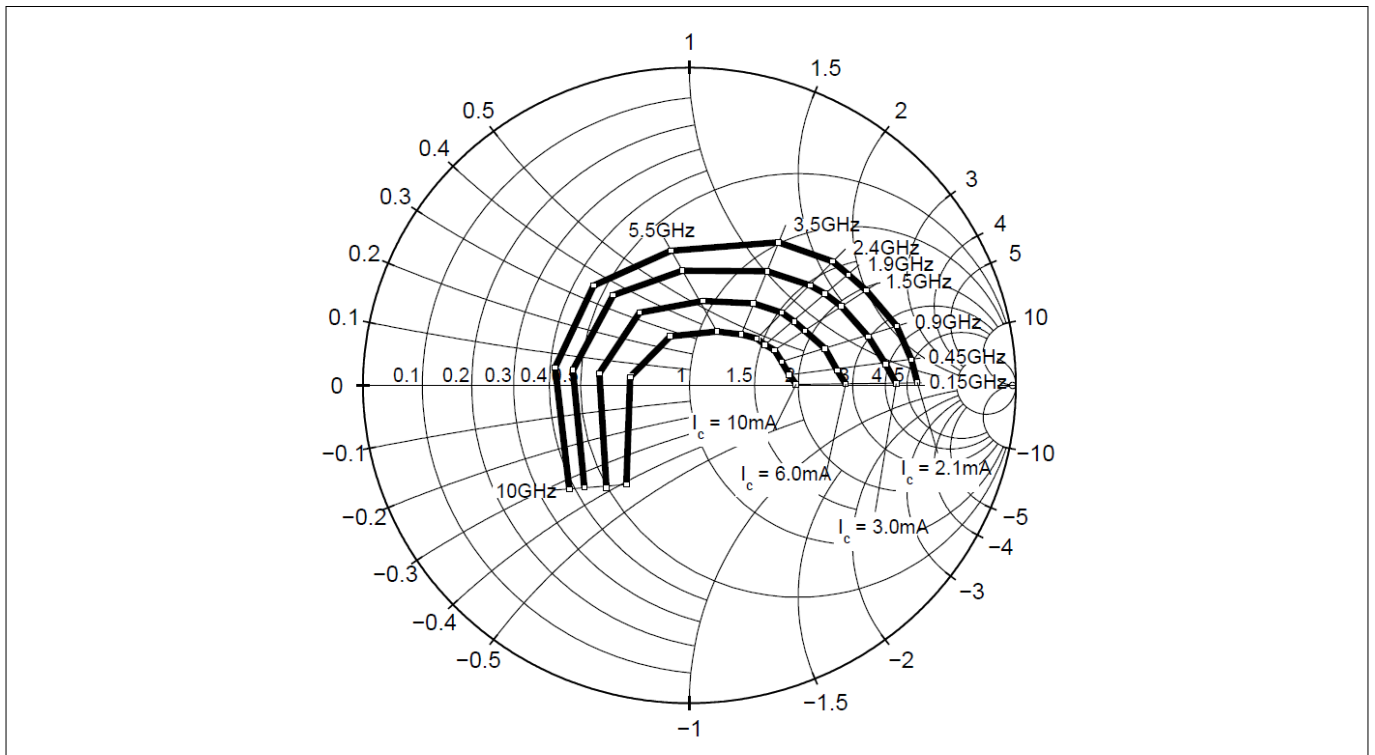

Figure 9 Input reflection coefficient  $S_{11} = f(f)$ ,  $I_C = \text{parameter}$

**Electrical characteristics**

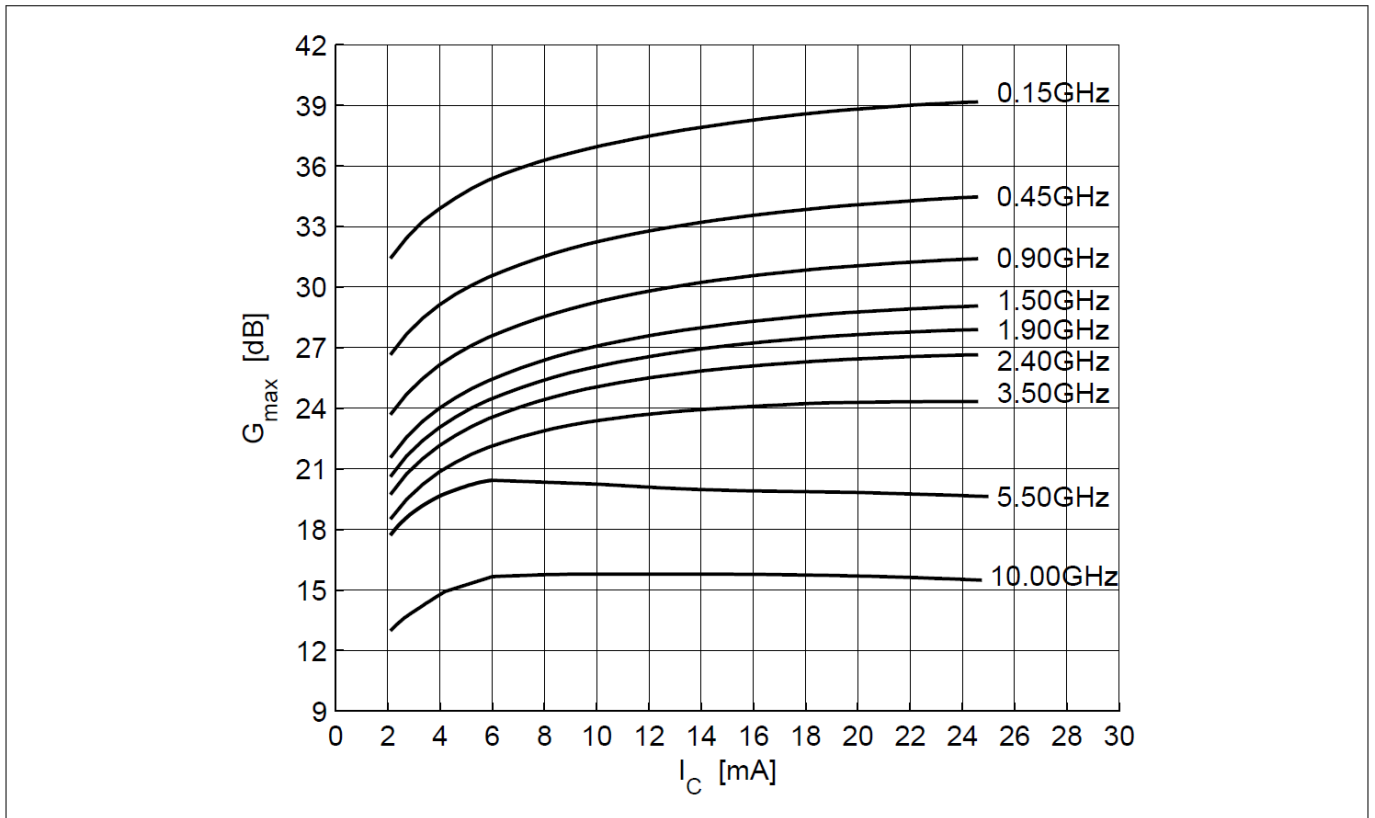

**Figure 10** Output reflection coefficient  $S_{22} = f(f)$ ,  $I_c = \text{parameter}$

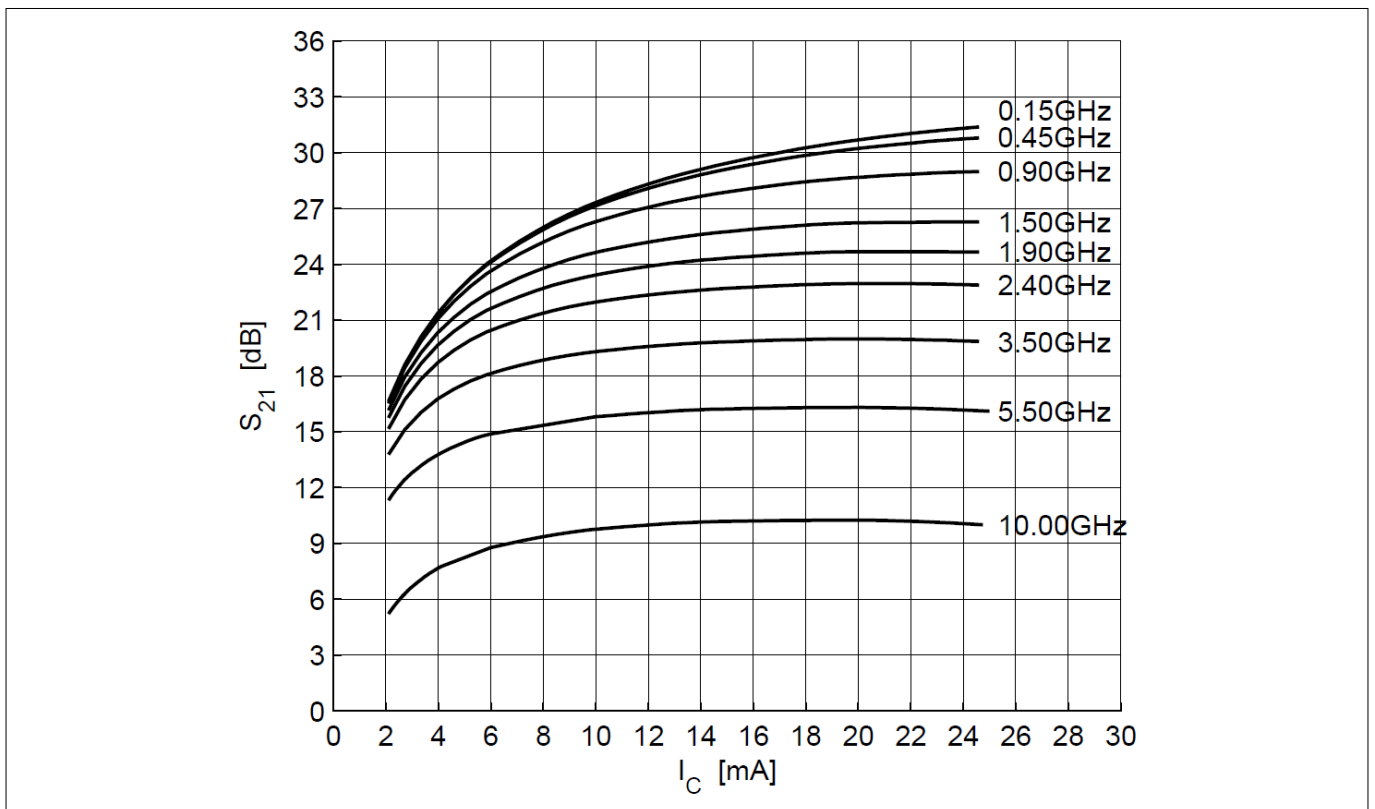

**Figure 11** Source impedance for minimum noise figure  $Z_{s,opt} = f(f)$ ,  $I_c = \text{parameter}$

**Electrical characteristics**



**Figure 12** Maximum power gain  $G_{max} = f(I_C)$ ,  $f = \text{parameter}$



**Figure 13** Transducer gain  $|S_{21}|^2 = f(I_C)$ ,  $f = \text{parameter}$

Electrical characteristics

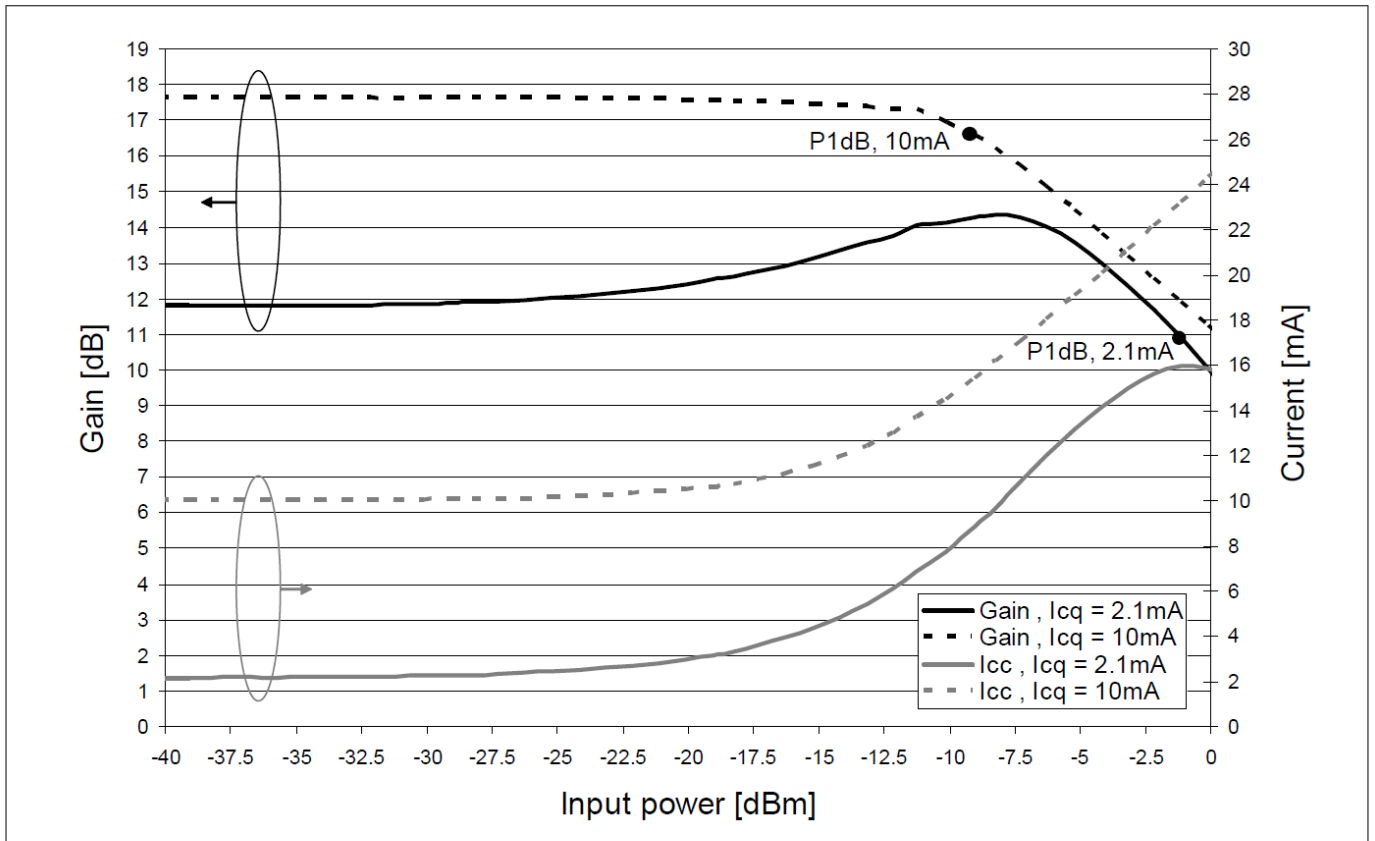
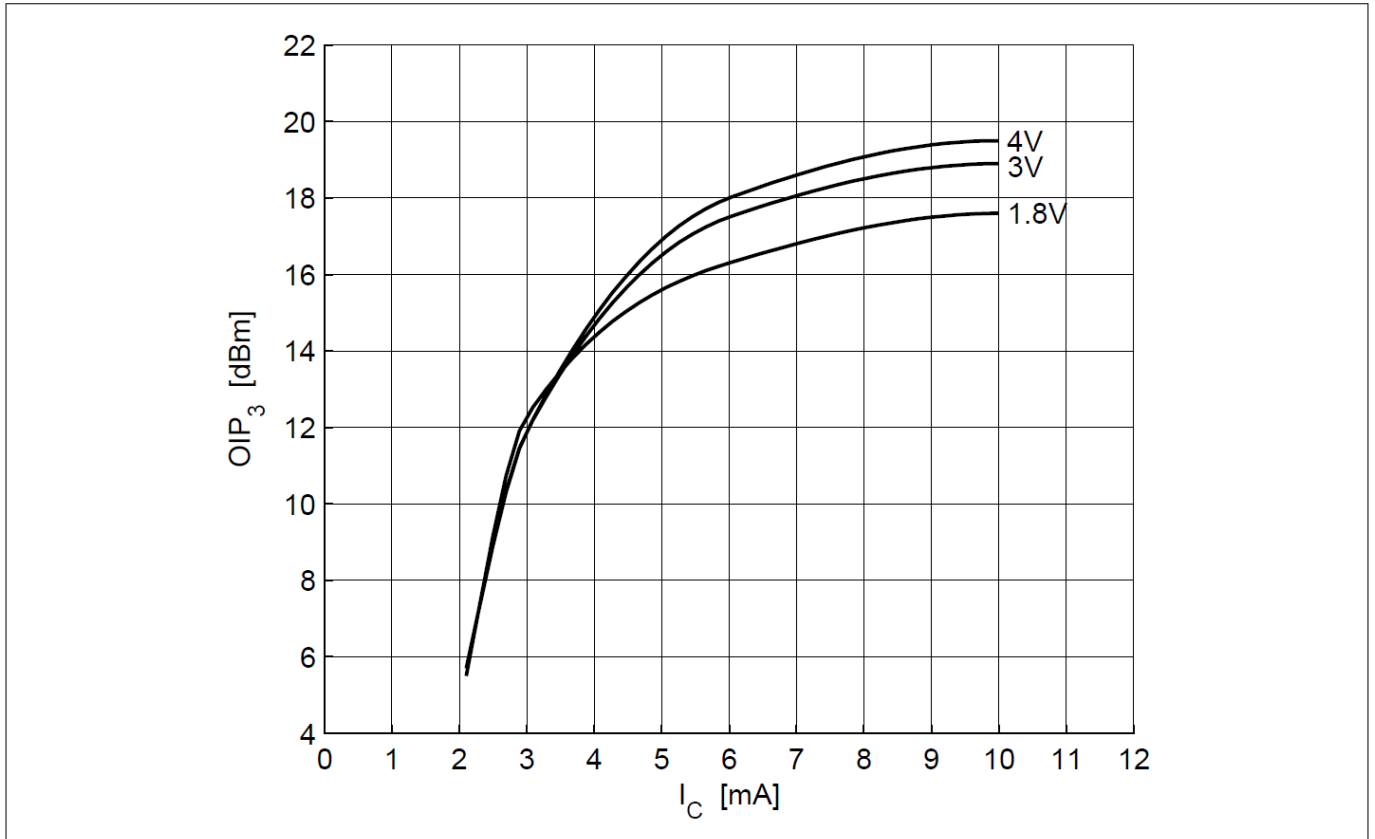
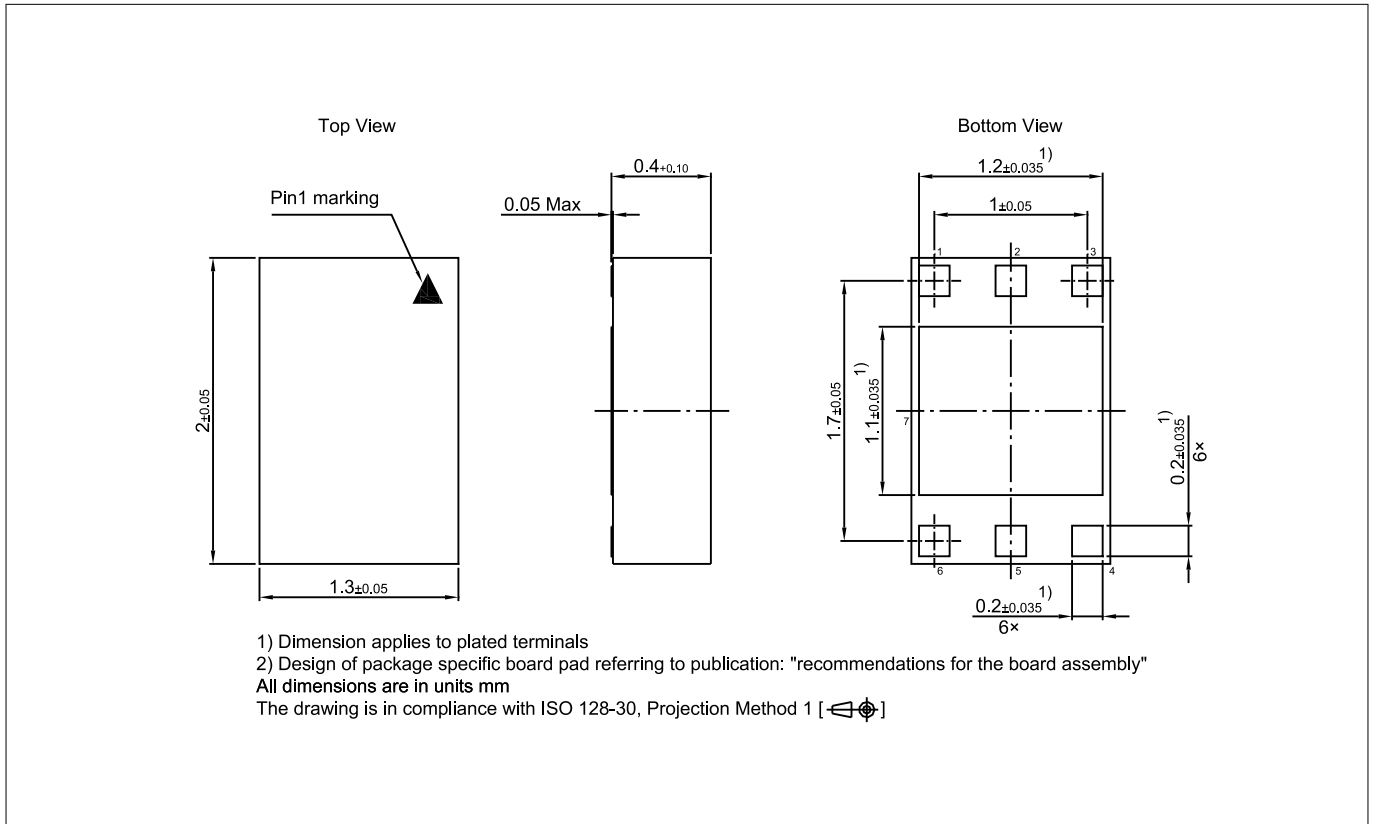

Figure 14 Power gain  $G = f(P_{RFIn})$  and supply current  $I_{CC} = f(P_{RFIn})$  at frequency  $f = 3.5$  GHz,  $I_{CQ}$  = parameter



**Figure 15** Output 3<sup>rd</sup> order intercept point  $OIP_3 = f(I_C)$  at frequency  $f = 3.5$  GHz,  $V_C =$  parameter

## 5 Package information TSLP-7-1



**Figure 16 TSLP-7-1 package**

Note: For package information including footprint, packing and assembly recommendation refer to:

<https://www.infineon.com/cms/en/product/packages/PG-TSLP/PG-TSLP-7-1>



**Revision history**

---

**Revision history**

<b>Document version</b>	<b>Date of release</b>	<b>Description of changes</b>
4.0	2018-09-26	New datasheet layout.
4.1	2021-07-14	Package outline marking corrected, link to Infineon package website added

## Trademarks

All referenced product or service names and trademarks are the property of their respective owners.

**Edition 2021-07-14**

**Published by**  
**Infineon Technologies AG**  
**81726 Munich, Germany**

**© 2021 Infineon Technologies AG**  
**All Rights Reserved.**

**Do you have a question about any**  
**aspect of this document?**  
**Email: [erratum@infineon.com](mailto:erratum@infineon.com)**

**Document reference**  
**IFX-gza1502360740368**

## IMPORTANT NOTICE

The information given in this document shall in no event be regarded as a guarantee of conditions or characteristics ("Beschaffheitsgarantie").

With respect to any examples, hints or any typical values stated herein and/or any information regarding the application of the product, Infineon Technologies hereby disclaims any and all warranties and liabilities of any kind, including without limitation warranties of non-infringement of intellectual property rights of any third party.

In addition, any information given in this document is subject to customer's compliance with its obligations stated in this document and any applicable legal requirements, norms and standards concerning customer's products and any use of the product of Infineon Technologies in customer's applications.

The data contained in this document is exclusively intended for technically trained staff. It is the responsibility of customer's technical departments to evaluate the suitability of the product for the intended application and the completeness of the product information given in this document with respect to such application.

## WARNINGS

Due to technical requirements products may contain dangerous substances. For information on the types in question please contact your nearest Infineon Technologies office.

Except as otherwise explicitly approved by Infineon Technologies in a written document signed by authorized representatives of Infineon Technologies, Infineon Technologies' products may not be used in any applications where a failure of the product or any consequences of the use thereof can reasonably be expected to result in personal injury.

# Mouser Electronics

Authorized Distributor

Click to View Pricing, Inventory, Delivery & Lifecycle Information:

[Infineon:](#)

[BGB 707L7ESD E6327](#)