

RDE5C1H470J0M1H03A

"#" indicates a package specification code.



< List of part numbers with package codes >
RDE5C1H470J0M1H03A

Shape

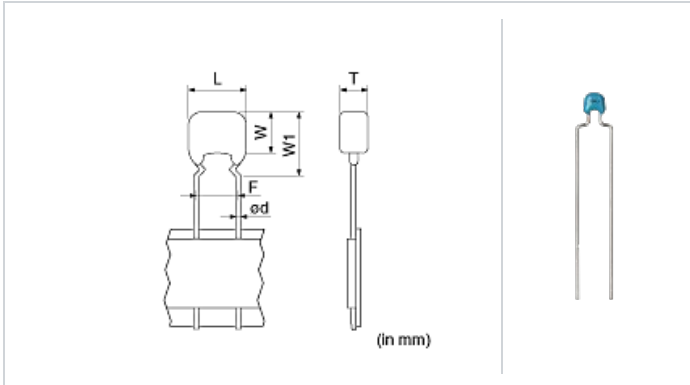

L size or outer diameter D (mm)	4.0 mm max.
W size	3.5 mm max.
T size	2.5 mm max.
Lead spacing F	5.0 +0.6/-0.2mm
Lead diameter d	0.5 ±0.05mm
W1 size (max.)	6.0mm

Notes

Meet LF(Lead Free)[※LF : Lead content is less than 1000 ppm.], HF(Halogen Free)

References

Packaging	Specifications	Minimum quantity
A	Ammo pack taping type	2000

Specifications

Capacitance	47pF ±5%
Rated voltage	50Vdc
Temperature characteristics (complied standard)	COG(EIA)
Temperature coefficient	0±30ppm/°C
Temperature range of temperature characteristics	25 to 125°C
Operating temperature range	-55 to 125°C

⚠ Attention

- 1.This datasheet is downloaded from the website of Murata Manufacturing Co., Ltd. Therefore, it's specifications are subject to change or our products in it may be discontinued without advance notice. Please check with our sales representatives or product engineers before ordering.
- 2.This datasheet has only typical specifications because there is no space for detailed specifications. Therefore, please review our product specifications or consult the approval sheet for product specifications before ordering.